



4EVER[®] *featuring*



4-IN-1 CAR SEAT

Read This Instruction Manual

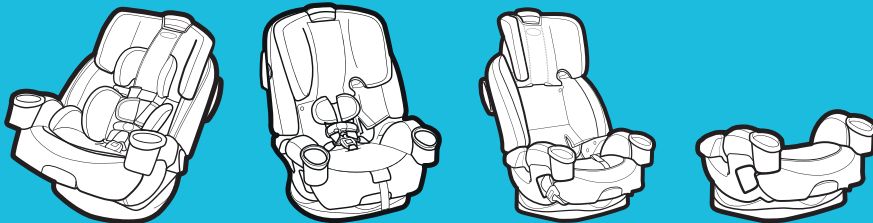

Do not install or use this child restraint until you read and understand the instructions in this manual.

FAILURE TO PROPERLY USE THIS CHILD RESTRAINT INCREASES THE RISK OF SERIOUS INJURY OR DEATH IN A SUDDEN STOP OR CRASH.

1 Important

Pages 4-13

- 1-A Welcome to the Graco Family!
- 1-B Safety Warnings
- 1-C Right Mode of Use
- 1-D Aircraft Installation

2 Features

Pages 14-19

3 Rear-Facing

Pages 20-31

- 3-A Rear-Facing Use
- 3-B Install Rear-Facing with Lower Anchor Attachment
- 3-C Install Rear-Facing with Vehicle Seat Belt

4 Forward-Facing

Pages 32-48

- 4-A Forward-Facing Use
- 4-B Install Forward-Facing with LATCH
- 4-C Install Forward-Facing with the Vehicle Seat Belt

5 Booster

Pages 49-64

- 5-A Booster Use
- 5-B Install Backed Booster
- 5-C Install Backless Booster

6 Securing Child

Pages 65-81

- 6-A Securing Child 5-Point Harness**
- 6-B Securing Child Backed Booster**
- 6-C Securing Child Backless Booster**

7 Moving the Lower Anchor Strap

Pages 82-85

8 Accessories

Page 86

9 Vehicle Information

Pages 87-93

- 9-A How to Uninstall Lower Anchor Connectors and Tether**
- 9-B Which Installation Method Should I use?**
- 9-C Choosing Vehicle Seat Location**
- 9-D Unsafe Vehicle Seat Location**
- 9-E Vehicle Seat Belts**

10 Care & Cleaning

Pages 94-97

- 10-A Cleaning Seat Pad**
- 10-B Cleaning Buckle Strap**
- 10-C Cleaning Harness, Lower Anchor Attachment and Tether Straps**



1 Important

1-A Welcome to the Graco Family!

Your child's safety depends on you. **No car seat can guarantee protection from injury in every situation, but proper use helps reduce the risk of serious injury or death. READ THIS MANUAL CAREFULLY.**

This child restraint system conforms to all applicable Federal motor vehicle safety standards.

Even if this car seat seems easy to figure out on your own, you must follow the detailed instructions in this instruction manual to ensure the steps are performed correctly.

If You Need Help

In the U.S.A, please contact our Customer Service Department with any questions you may have concerning parts, use, or maintenance. When you contact us, please have your product's model number and date of manufacture ready so that we may help you efficiently. These numbers can be found on a sticker on the back side of your car seat.

Contact us at **www.gracobaby.com or call 1-800-345-4109.**

For additional resources or to get your car seat checked by a child passenger safety technician, please visit the following web sites:

www.nhtsa.gov • www.seatcheck.org • www.safekids.org

This car seat is for children: *Rear-Facing: 4-40 lb (1.8-18 kg)*
Forward-Facing: 26.5-65 lb (12-30 kg)
Backed Booster: 40-100 lb (18.1-45 kg)
Backless Booster: 40-120 lb (18.1-54 kg)

- Infants who weigh less than 26.5 lb (12 kg) **MUST be rear-facing**. Review section 1-C for more information.

Note: Preterm or low birth weight infants may be at special risk in a vehicle or aircraft. According to the AAP, these infants may suffer breathing issues if improperly reclined in a car seat. When rear-facing, use the corrected age for preemies. Graco advises that you have your physician or hospital staff evaluate your infant and recommend the proper car seat or car bed before you and your infant leave the hospital.

Install Cup Holders

Cup holders must be installed.

To attach the cup holders, match the right cup holder (find the letter R on the bottom of the cup holder) to the right side of the seat and the left “L” to the left.

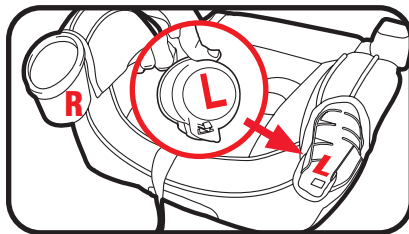

1 Important

Move the fabric aside, and align the tab behind the cup holder with the slot in the seat.



Align the tab on the bottom of the cup holder with the hole in the seat.

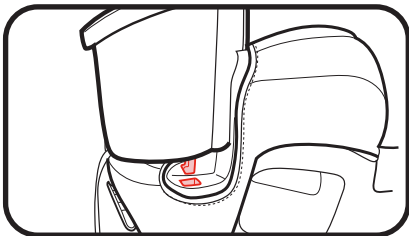
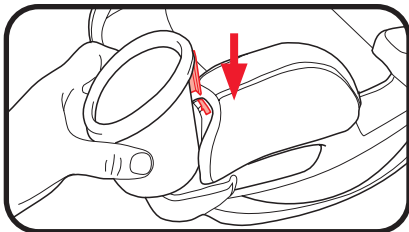

Use both hands to push down hard on the cup holder. **You will hear a “Click” when they are secured in place.**

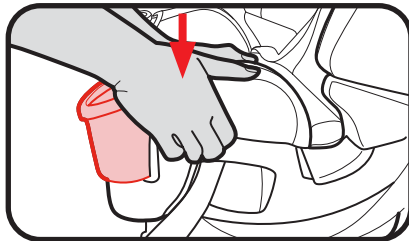



1 Important

Register This Child Restraint

Please fill out the prepaid registration postcard attached to the harness and mail it in today **or register online at www.gracobaby.com/carseatregistration.**

Child restraints could be recalled for safety reasons. You must register this restraint to be reached in a recall. Send your name, address, and the restraint's model number and manufacturing date to:

Graco Children's Products, Inc.

Attn: Customer Service

P.O. Box 169, Elverson, PA 19520-9901

or call 1-800-345-4109 **or register online at**
www.gracobaby.com/carseatregistration

For recall information, call the U.S. Government's Vehicle Safety Hotline at 1-888-327-4236 (TTY: 1-800-424-9153), or go to <http://www.NHTSA.gov>.

For future reference or if you change addresses, record the model name, model number, date of manufacture and purchase date of this car seat on the below. You can find this information either on the registration card if you still have it or on the date label located on the back of the car seat.

Model Name _____
Model Number _____
Date of Manufacture _____
Date of Purchase _____



1 Important

1-B Safety Warnings

! WARNING!

Failure to follow these instructions and child restraint's labels can result in child striking the vehicle's interior during a sudden stop or crash

! According to accident statistics, children are safer when properly restrained in the rear seating positions than in the front seating positions. The center of the back seat can be the safest during a possible side impact.



! NEVER place this child restraint rear-facing in a vehicle seating location that has an active front air bag.

If an air bag inflates, it can hit the child and car seat with great force and cause serious injury or death to your child.

- ! Review your vehicle owner's manual for more information about air bags and car seat use.**
- ! If your vehicle does not have a back seat, review your vehicle owner's manual.**
- ! Choose the correct mode of use for the car seat depending on your child's size. Infants less than 26.5 lb (12 kg) MUST use this car seat rear-facing.**

- ! Select a suitable location for the car seat in your vehicle.**
- ! Secure car seat with a vehicle seat belt or lower anchor strap that is properly routed as shown in this manual.**
- ! Vehicle seat belt system MUST hold car seat securely. Not all vehicle seat belts can be used with a car seat.**
- ! If vehicle seat belt does not hold car seat securely, read “Vehicle Seat Belts” section 9-E and your vehicle owner’s manual.**
- ! Always secure car seat with lower anchor attachment or a vehicle seat belt, even when unoccupied. In a crash, an unsecured car seat can injure passengers.**
- ! If car seat is in a crash, it must be replaced. DO NOT use it again! A crash can cause unseen damage, and using it again could result in serious injury or death.**
- ! DO NOT use car seat if it is damaged or missing parts.**
- ! DO NOT use accessories or parts other than those provided by Graco. Their use could alter the performance of the car seat.**
- ! DO NOT remove lower anchor attachment system from car seat. If using vehicle seat belt to secure car seat, lower anchor connectors must be stored.**
- ! Never leave child unattended, even when sleeping. Child may become tangled in harness straps and suffocate or strangle.**



1 Important

! Rear-facing car seat must be properly leveled:

- Too reclined can result in injury or ejection.
- Too upright can result in breathing difficulties.



! Never attach two lower anchor connectors to one vehicle lower anchor point unless specifically allowed by the vehicle manufacturer.

! Do not use both the vehicle belt and lower anchor belts at the same time when using the car seat rear or forward facing.

! The American Academy of Pediatricians (AAP) and National Highway Safety Administration (NHTSA) recommend that children ride rear facing until the age of 2 or until they reach the maximum rear-facing height or weight rating for their seat, and when forward-facing, children should use the built-in harness system for as long as possible until they reach the maximum forward-facing weight or height for their car seat. After reaching the maximum forward-facing weight or height, they also recommend that children 4' 9" inches tall or under should ride in a belt-positioning booster seat.

*Graco Supports the American Academy of Pediatrics and National Highway Traffic Safety Administration's Car Seat Guidelines. Visit www.gracobaby.com/en-US/safety for information on car seat usage recommendations.

Car Seat's Useful Life

STOP using this car seat and throw it away 10 years after the date of manufacture. Look for this sticker on back of the car seat.

Graco Children's Products Inc. advises against loaning or passing along a car seat unless you know the complete history of the product. We also advise against purchasing a car seat second hand.

Warm Weather Use

Car seat parts can get very hot in the sun or warm weather. **To avoid burns, always check before putting child in car seat.**



1 Important

1-C Right Mode of Use

4 lb (1.8 kg)	26.5 lb (12 kg)	40 lb (18.1 kg)	65 lb (30 kg)	120 lb (54 kg)
------------------	--------------------	--------------------	------------------	-------------------

Rear-Facing with 5-Point Harness

Must be 49" (125 cm) or less:

4-26.5 lb (1.8-12 kg) less than 1 year old **MUST** be rear-facing.

26.5-40 lb (12-18 kg) **SHOULD** be rear-facing.*

Forward-Facing with 5-Point Harness

Must be 49" (125 cm) or less:

26.5-40 lb (12-18 kg) can sit upright unassisted **CAN** be forward-facing.

40-65 lb (18-30 kg) **SHOULD** be forward-facing.*

Booster Mode with Vehicle Lap/Shoulder Seat Belt

Must be 43-57" (110.1-145 cm) tall and 4+ years old

40-65 lb (18.1-30 kg) **CAN** be in backed booster mode.

40-65 lb (18.1-30 kg) **CAN** be in backless booster mode.

Over 65 lb (30 kg) **MUST** be in booster mode.*

*Check your state laws and the AAP/NHTSA recommendations. Review page 10 more for information.

1-D Aircraft Installation



This child restraint is certified for use in aircraft. Use only on forward-facing aircraft seats. Follow the instructions for vehicle installation. For rear-facing installation, see section 3-C and 9-E Lap Belt Installation. For forward-facing installation, see section 4-C and 9-E Lap Belt Installation, but do not use tether.



This child restraint is NOT certified for use in aircraft when used as a booster seat because aircrafts do not have shoulder belts.

Contact the airline for their specific policies.

When installing the car seat, route the lap seat belt through the proper path, and buckle it in. Then, pull on the tail of the belt so that the lap belt gets tight around the car seat.

Grab the sides of the seat at the belt path where the lap belt is, and move the car seat from side-to-side and front-to-back. If it moves less than 1" (2.5 cm), it is tight enough.

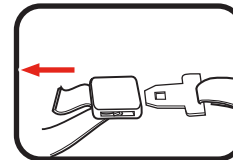

2-A Car Seat Features



2 Features

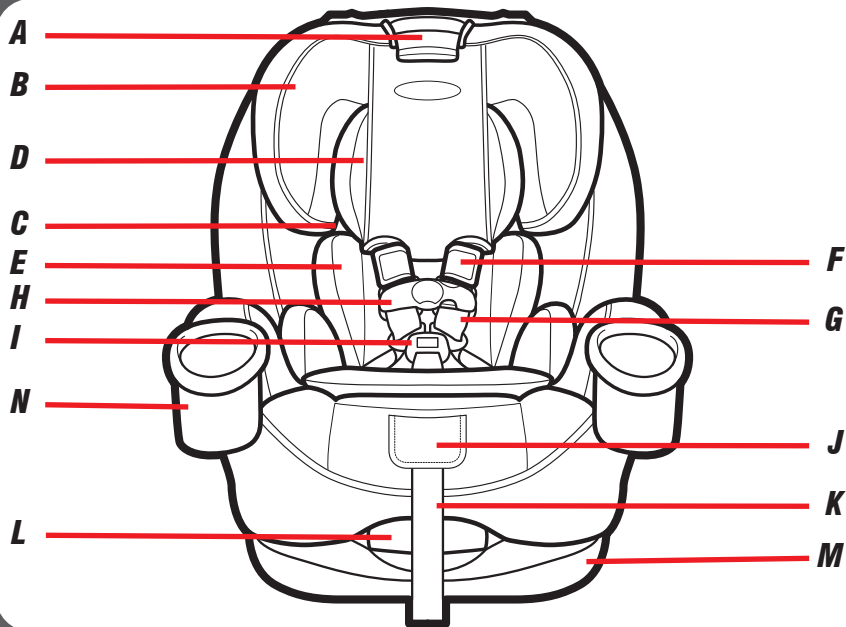

- A Headrest/Harness Adjustment Lever**
- B Headrest**
- C Booster Shoulder Belt Guide**
- D Headrest Infant Support**
- E Infant Body Support**
- F Harness Covers**
- G Harness Straps**
- H Chest Clip**
- I Buckle**
- J Harness Release Lever (under flap)**
- K Harness Adjustment Strap**
- L Recline Handle**
- M Seat Base**
- N Cup Holder**
- O Belt Lock-Off (under seat back pad)**

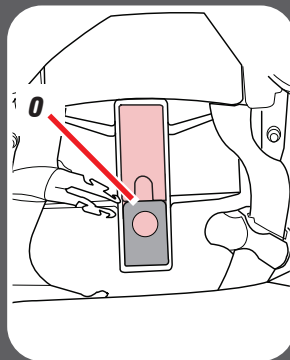



2 Features

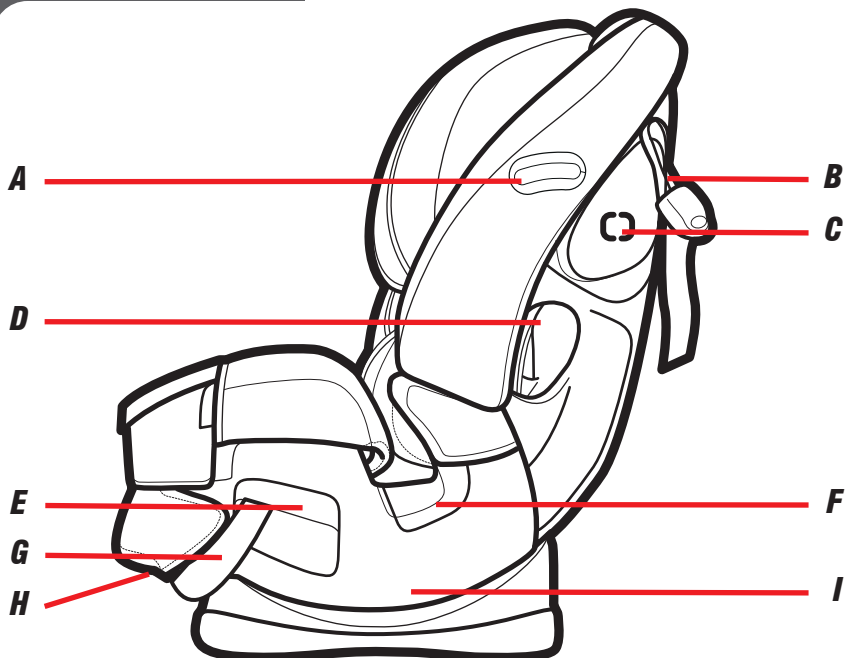

- A Level Indicator***
- B Tether Strap***
- C TrueShield Bolster***
- D Forward-Facing Belt Path***
- E Rear-Facing Belt Path***
- F Booster Lap Belt Path***
- G Lower Anchor Strap***
- H Rear-Facing Lower Anchor Strap Storage (under seat)***
- I Recline Position Indicator***



2 Features



2 Features

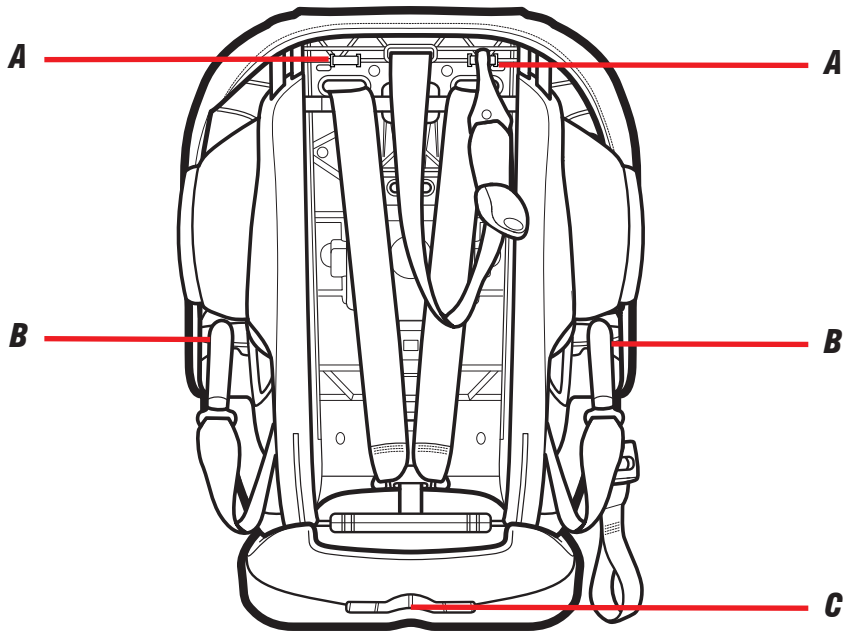

- A Tether Strap Storage***
- B Forward-Facing Lower
Anchor Strap Storage***
- C Instruction Manual Storage***



2 Features

3-A Rear-Facing Use

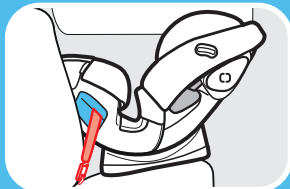

Lower Anchor Attachment



**Vehicle Seat Lap/
Shoulder Belt**

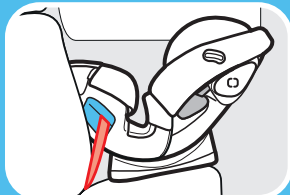

Vehicle Seat Lap Belt

Rear-Facing:

4-40 lb (1.8-18 kg) and 49" (125 cm) or less in height

- Infants who weigh less than 26.5 lb (12 kg) **MUST be rear-facing.**
- Children are safer riding rear-facing and should ride rear-facing as long as possible, until they reach the maximum rear-facing height or weight rating for their car seat. Then children should ride forward-facing, using the built-in harness system for as long as possible until they reach the maximum forward-facing weight or height for their car seat. Be sure to check your local and state laws, as well as AAP and NHTSA recommendations, for car seat usage.



WARNING! NEVER place this child restraint rear-facing in a vehicle seating location that has an active front air bag.



**3 Rear
Facing**

3-B Install Rear-Facing with Lower Anchor Attachment

Review your vehicle's owner manual for lower anchor location and use.

1. Store Tether Strap

Attach tether hook to the plastic bar on either side of the car seat.

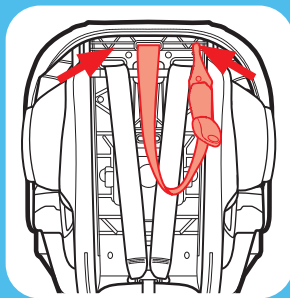

2. Remove Lower Anchor Strap from Storage Location

Push in on the red buttons on the lower anchor connectors, and remove from storage position.

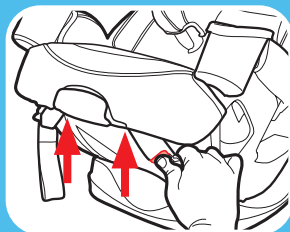

3 Rear Facing



3 Rear
Facing

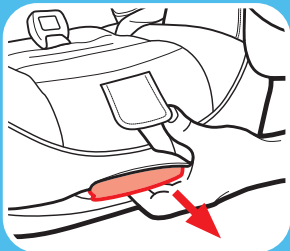
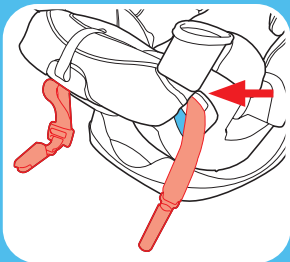

3. Make Sure Lower Anchor Strap is in the Rear-Facing Belt Path Marked With a Blue Label

If not, See section 7 to move lower anchor strap.

4. Recline the Car Seat

Place the car seat in 1st, 2nd or 3rd recline position.

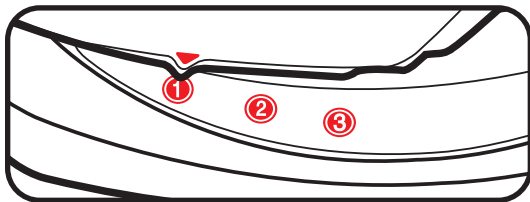

5. Place Car Seat Rear-Facing in Back Seat of the Vehicle

Place rear-facing in vehicle seat and center the car seat between the lower anchors. The base should sit as flat as possible on the vehicle seat.

6. Extend the Lower Anchor Strap.

For easier installation, extend the lower anchor strap to its maximum length by pressing the grey button and pulling on the strap.

7. Check the Level Indicator

Vehicle **MUST** be on level ground. Check the level indicator on the car seat. The **bubble must be completely within** the blue zone.

Adjust the recline until the bubble is completely within the blue zone.

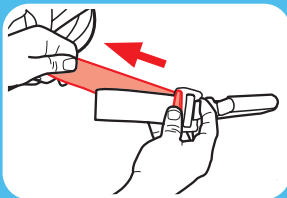
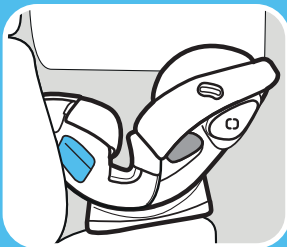



3 Rear
Facing

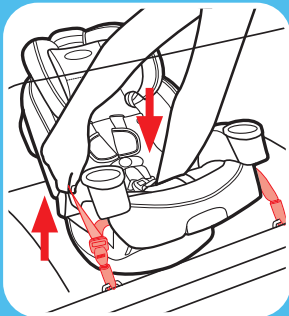

8. Attach Lower Anchor Connectors to Vehicle's Lower Anchors.

Lower anchor strap should lie flat and not be twisted.

Lower anchor attachment can only be used if the vehicle lower anchor spacing is 11" (28 cm) from the center of one lower anchor to the center of the other lower anchor.

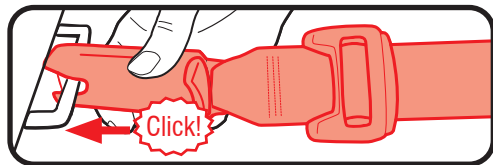

9. Tighten the Lower Anchor Strap

Press down firmly in the center of the car seat while tightening the lower anchor strap. You may need to tighten through the slit in the pad at the belt path as shown.

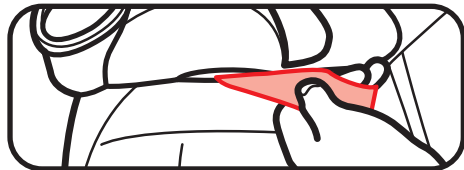

10. Test For Tightness

Grab the sides of the seat where the lower anchor strap is, and slide the car seat side-to-side and front-to-back.

If the seat moves less than 1" (2.5 cm), it is tight enough.

11. Check the Level Indicator

Vehicle **MUST** be on level ground.

Check the level indicator on the car seat. The **bubble must be completely within** the blue zone. Readjust if needed.

See section 6-A to secure your child.

Recheck the level indicator with child in seat.



3 Rear Facing

Is Everything Correct?

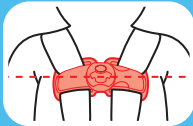
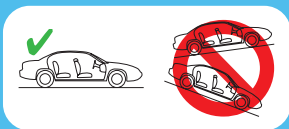

Car Seat Does Not Move More than 1" (2.5 cm) at the Belt Path

Level Indicator's Bubble in the Blue Zone and Vehicle on Level Ground



Harness Straps at or Just Below the Child's Shoulders.

Review section 6

Chest Clip Even With Armpits

Review section 6

Cannot Pinch Harness Straps at the Shoulder

Review section 6



3 Rear Facing

3-C Install Rear-Facing with Vehicle Seat Belt

1. Store Tether and Lower Anchor Straps

Attach tether hook and lower anchor connectors to the plastic bars as shown.

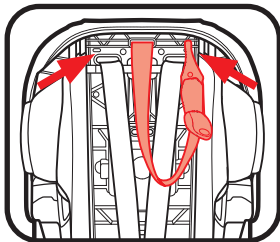

2. Recline the Car Seat

Place the car seat in 1st, 2nd or 3rd recline position.

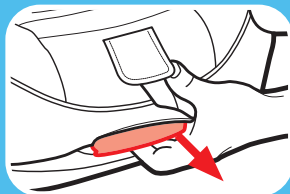
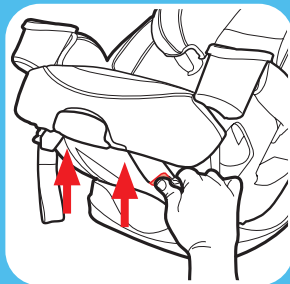
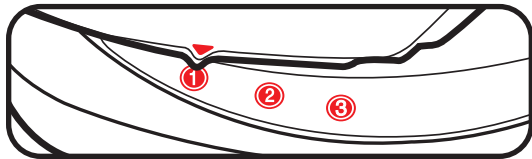



3. Place Car Seat Rear-Facing in Back Seat of the Vehicle

Place rear-facing in vehicle seat. The base should sit as flat as possible on the vehicle seat.

4. Check the Level Indicator

Vehicle **MUST** be on level ground.

Check the level indicator on the car seat. The **bubble must be completely within** the blue zone.

Adjust the recline until the bubble is completely within the blue zone.

Review your vehicle's owner manual for vehicle seat belt use

5. Route the Vehicle Seat Belt

Thread vehicle seat belt through the rear-facing belt path (marked with a blue label) and out the other side. Buckle it. The seat belt should lie as flat as possible and not be twisted.

Note: It may be easier to route the vehicle seat belt by lifting seat pad up to expose the belt path.

Make sure the vehicle seat belt is in front of the buckle strap when the buckle is in the inner-most position, and in behind when in the outer-most position.

6. Lock Vehicle Seat Belt

In most vehicles today, slowly pull the shoulder belt all the way out, and then let it go back in. You will hear a clicking sound. Slowly pull out on the belt and it should be locked. If not, review your car's owner manual and section 9-E.

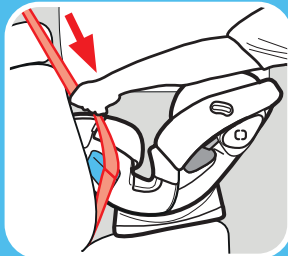
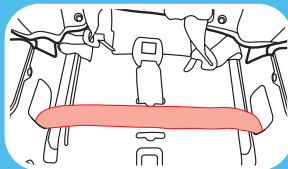
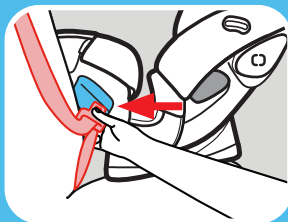

3 Rear Facing

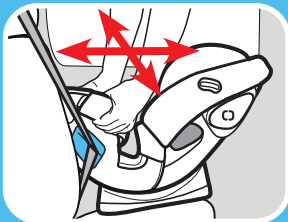
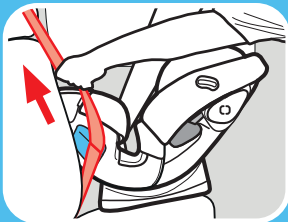

7. Tighten the Vehicle Seat Belt

Press down firmly in the center of the car seat. Pull on the shoulder belt to tighten while feeding the slack back in the retractor.

8. Test For Tightness

Grab the sides of the seat where the vehicle seat belt is and slide the car seat side-to-side and front-to-back.

If the seat moves less than 1" (2.5 cm), it is tight enough.

9. Check the Level Indicator

Vehicle **MUST** be on level ground.

Check the level indicator on the car seat. The **bubble must be completely within** the blue zone. Readjust if needed.

See section 6-A to secure your child.

Recheck the level indicator with child in seat.

Is Everything Correct?

Car Seat Does Not Move More than 1" (2.5 cm) at the Belt Path

Level Indicator's Bubble in the Blue Zone and Vehicle on Level Ground



Harness Straps at or Just Below the Child's Shoulders.

Review section 6

Chest Clip Even With Armpits

Review section 6

Cannot Pinch Harness Straps at the Shoulder

Review section 6

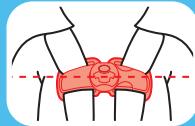
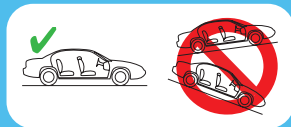

3 Rear Facing



4 Forward Facing

4-A Forward-Facing Use

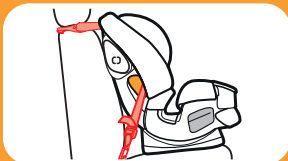

LATCH: Do not install by this method for a child weighing more than 45 lb (20 kg)

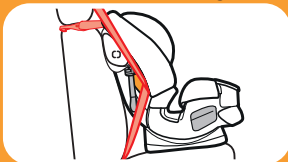

Vehicle Seat Lap/Shoulder Belt with Tether

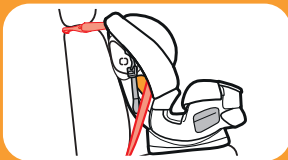

Vehicle Seat Lap Belt with Tether

Forward-Facing:
26.5-65 lb (12-30 kg)
49" (125 cm) or less

- For children 40 lb or less (18 kg), **MUST** use recline position 4 or 5.
- For children over 40 lb (18 kg) you **MUST** use recline position 6.
- Children are safer riding rear-facing and should ride rear-facing as long as possible, until they reach the maximum rear-facing height or weight rating for their car seat. Then children should ride forward-facing, using the built-in harness system for as long as possible until they reach the maximum forward-facing weight or height for their car seat. At that point, children should ride in a belt-positioning booster seat. Be sure to check your local and state laws, as well as AAP and NHTSA recommendations, for car seat usage.

4-B Install Forward-Facing with LATCH

Review your vehicle's owner manual for LATCH location and use. Do not install by this method for a child weighing more than 45 lb (20 kg)



4 Forward Facing

1. Remove Lower Anchor Strap from Storage Location

Push in on the red buttons on the lower anchor connectors, and remove from storage position.

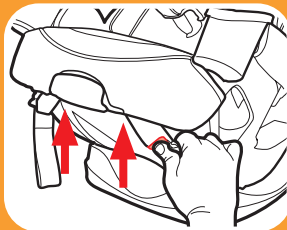

2. Make Sure Lower Anchor Strap is in the Forward-Facing Belt Path Marked with Orange Label

To move the lower anchor strap, review section 7.

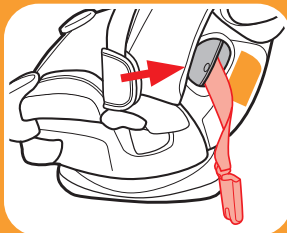

4 Forward Facing

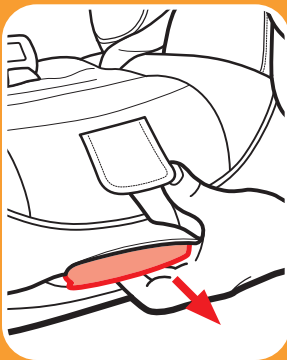
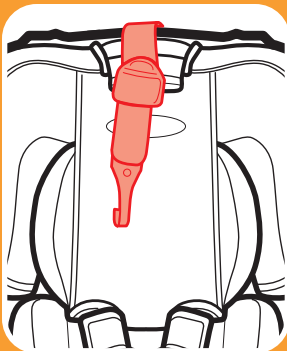

3. Unhook Tether Strap From Storage

Unhook tether and lay it in the seat.

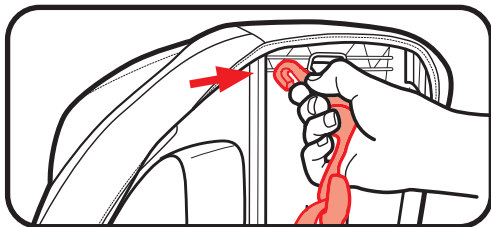

4. Adjust the Car Seat

For children 40 lb or less (18 kg), **MUST** use recline position 4 or 5.

For children over 40 lb (18 kg) you **MUST** use recline position 6.

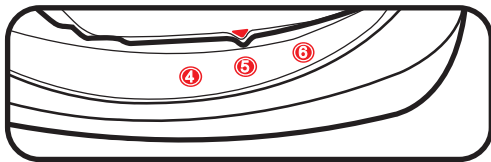

5. Place Car Seat Forward-Facing in Back Seat of the Vehicle

Place forward-facing in vehicle seat, and center the car seat between the lower anchors. The base should sit as flat as possible on the vehicle seat.

6. Extend the Lower Anchor Strap.

For easier installation, extend the lower anchor strap to its maximum length by pressing the grey button and pulling on the strap.

7. Attach Lower Anchor Connector to Vehicle's Lower Anchors.

Lower anchor strap should not be twisted.

Lower anchor attachment can only be used if the vehicle lower anchor spacing is 11" (28 cm) from the center of one lower anchor to the center of the other lower anchor.

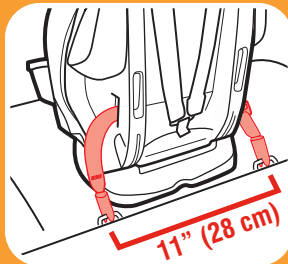
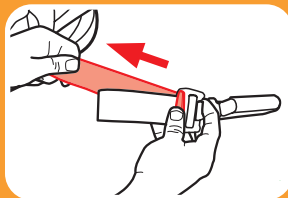
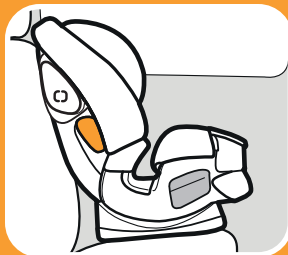
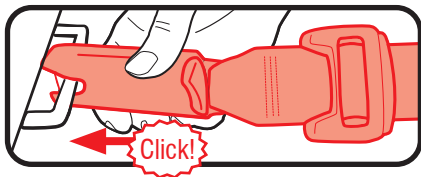

4 Forward Facing

4 Forward Facing

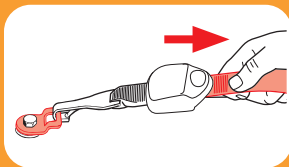
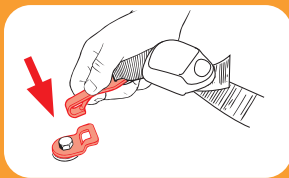
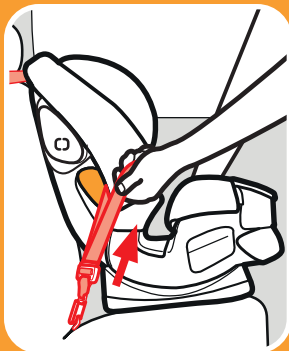

8. Tighten the Lower Anchor Strap

Press down firmly in the center of the car seat while tightening the lower anchor strap. You may need to tighten through the slit in the pad at the belt path as shown.

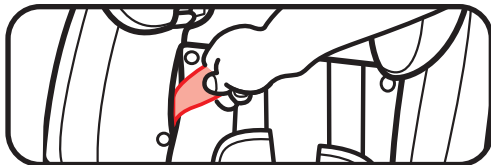

9. Attach Tether Strap

Extend the tether by lifting up on the tether lock and attach.

Consult vehicle's owner manual for specific location.

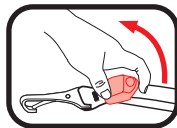

10. Tighten Tether Strap

Remove all the slack.

11. Test For Tightness

Grab the sides of the seat where the lower anchor strap is, and slide the car seat side-to-side and front-to-back.

If the seat moves less than 1" (2.5 cm), it is tight enough.

See section 6-A to secure your child.



4 Forward Facing

Is Everything Correct?



Car Seat Does Not Move More than 1" (2.5 cm) at the Belt Path



Harness Straps Just Above the Child's Shoulders.

Review section 6



Chest Clip Even With Armpits

Review section 6



Cannot Pinch Harness Straps at the Shoulder

Review section 6

4-C Install Forward-Facing with Vehicle Seat Belt



4 Forward Facing

1. Store Lower Anchor Straps

Attach lower anchor connectors to the plastic bars as shown.

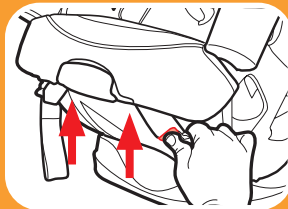

2. Unhook Tether Strap From Storage

Unhook tether, and lay it in the seat.

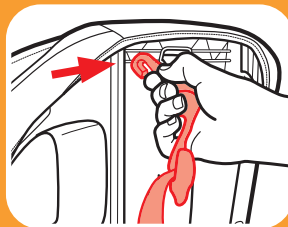
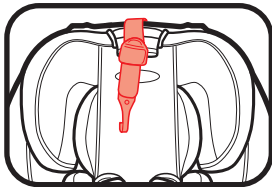

4 Forward Facing

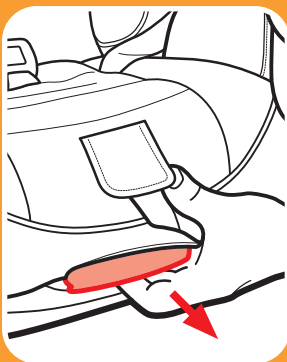

3. Place Car Seat Forward- Facing in Back Seat of the Vehicle

Place forward-facing in vehicle seat. The base should sit as flat as possible on the vehicle seat.

4. Adjust the Car Seat

**For children 40 lb or less (18 kg),
MUST use recline position 4 or 5.**

**For children over 40 lb (18 kg),
MUST use recline position 6.**

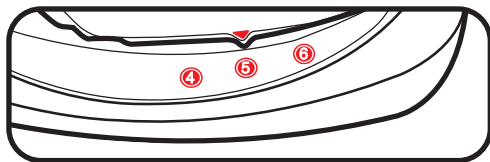

Using With the Lock-Off:

5. Expose the Lock-Off

- A.** Loosen the harness straps.
- B.** Raise the headrest to the highest position.
- C.** Unbuckle the chest clip.
- D.** Unbuckle the buckle.

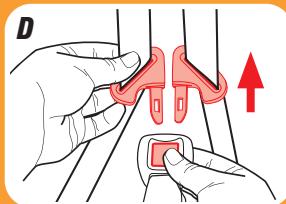
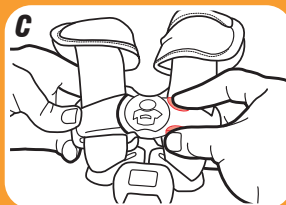
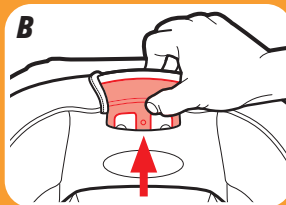
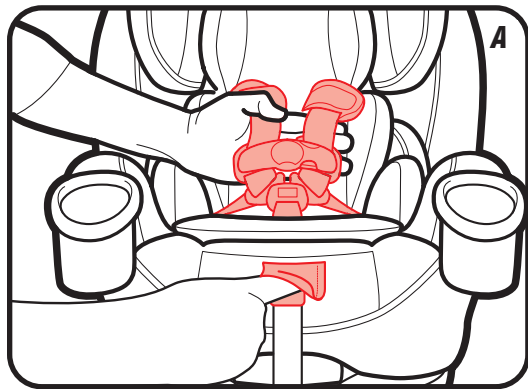

4 Forward
Facing

4 Forward Facing

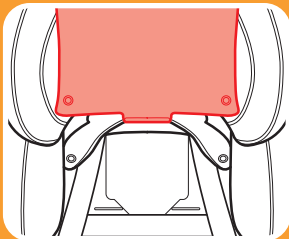

E. Lift the headrest pad flap up out of the way.

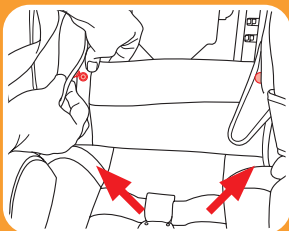

F. Undo the 2 lower snaps.

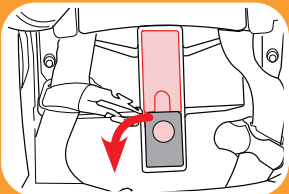

6. Open the Lock-Off

Hold the upper (red) latch in position, then flip down the lower (gray) tab. Release the upper latch.

Review your vehicle's owner manual for vehicle seat belt use

7. Route the Vehicle Seat Belt

Thread vehicle seat belt through the forward-facing belt path (marked with an orange label), through the lock-off, and out the other side. Buckle the seat belt. The seat belt should lie as flat as possible and not be twisted.

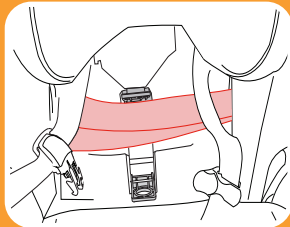
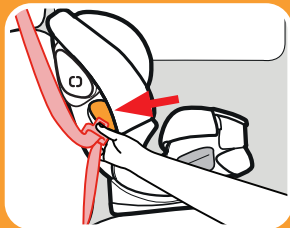

4 Forward Facing

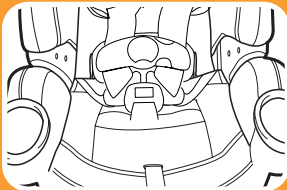
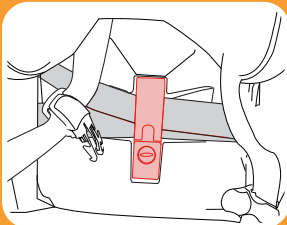

8. Tighten the Vehicle Seat Belt

Press down firmly in the center of the car seat. Pull on the shoulder belt to tighten. When the belt is tight, close and lock the lock-off on top of the vehicle seat belt.

*Make sure the lap and shoulder belt are both routed under the lock-off.

9. Replace the Seat Pad

Move the headrest back to its proper position for your child.

Review your vehicle's owner manual for vehicle seat belt use

Using Without the Lock-Off:

5. Route the Vehicle Seat Belt

Thread vehicle seat belt through the forward-facing belt path (marked with an orange label) and out the other side. Buckle the seat belt. The seat belt should lie as flat as possible and not be twisted.

6. Lock the Vehicle Seat Belt

In most vehicles today, slowly pull the shoulder belt all the way out and then let it go back in. You will hear a clicking sound. Slowly pull out on the belt and it should be locked. If not, review your car's owner manual and section 9-E.

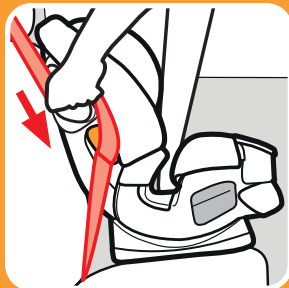
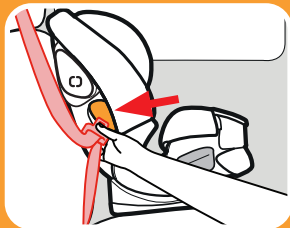

4 Forward Facing



7. Tighten the Vehicle Seat Belt

Press down firmly in the center of the car seat. Pull on the shoulder belt to tighten while feeding the slack back in the retractor.

After step 7, continue with step 10 on the next page.

10. Attach Tether Strap

Extend the tether by lifting up on the tether lock and attach.

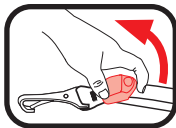

Consult vehicle's owner manual for specific location.

11. Tighten the Tether Strap

Push the car seat back while tightening the tether strap to remove all the slack.

12. Test For Tightness

Grab the sides of the seat where the vehicle seat belt is and slide the car seat side-to-side and front-to-back.

If the seat moves less than 1" (2.5 cm), it is tight enough.

See section 6-A to secure your child.

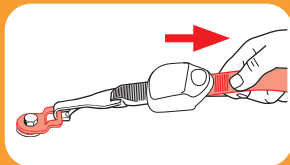
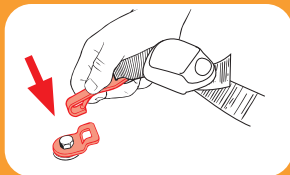

4 Forward
Facing

Is Everything Correct?



Car Seat Does Not Move More than 1" (2.5 cm) at the Belt Path

Harness Straps Just Above the Child's Shoulders.

Review section 6

Chest Clip Even With Armpits

Review section 6

Cannot Pinch Harness Straps at the Shoulder

Review section 6

5-A Booster Use

Booster Use With Back:

**40-100 lb (18.1-45 kg) 43-57”
(110.1-145 cm) at least 4 years old**

Booster Use Without Back:

**40-120 lb (18.1-54 kg) 43-57”
(110.1-145 cm) at least 4 years old**

- When forward-facing, children should use the built-in harness system for as long as possible until they reach the maximum forward-facing weight or height for their car seat. At that point, children should ride in a belt-positioning booster seat. A booster is no longer needed once the vehicle seat belt fits properly, typically when they reach 4 feet 9 inches tall and are between ages 8-12. Be sure to check your local and state laws, as well as AAP and NHTSA recommendations, for car seat usage.



**Vehicle Lap/Shoulder
Seat Belt**



**Vehicle Seat Lap/
Shoulder Belt**



**5
Booster**



5 Booster



Never Use a Vehicle Lap-Only Belt Across Front of Child

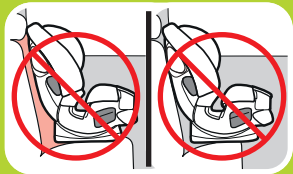

- **DO NOT** position vehicle shoulder belt under the child's arm or back.
- **DO NOT** allow child to slouch or slide down in the booster seat.
- **DO NOT** position vehicle belt over top of armrests.
- Vehicle's seat headrest **SHOULD NOT** create a gap between vehicle seat and booster seat.
- The front of booster seat **MUST NOT** hang over front of vehicle seat.
- If child will not keep vehicle belt properly positioned, **DO NOT** use this booster seat. Use a different car seat.

5-B Install Backed Booster

1. Store The Harness System

- A. Loosen the shoulder straps as much as possible.**
- B. Raise the headrest to the highest position.**
- C. Unbuckle the chest clip and the buckle strap D.**

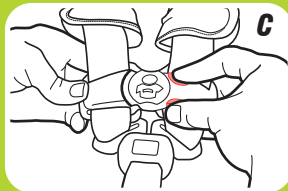
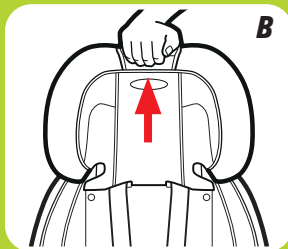
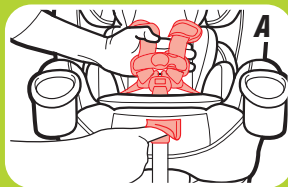
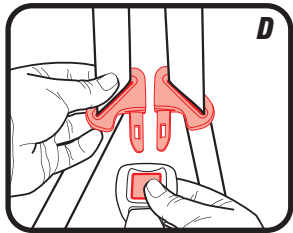

5 Booster



5 Booster

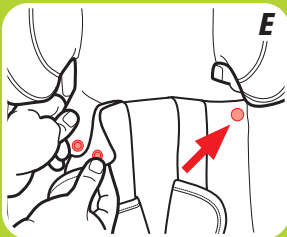

E. Unsnap Pad and Expose Seat Back

Undo the 2 snaps in the headrest pad.

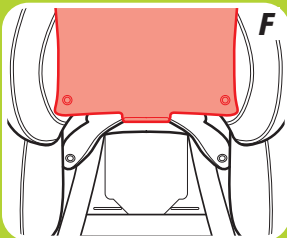

F. Lift the headrest pad flap up out of the way.

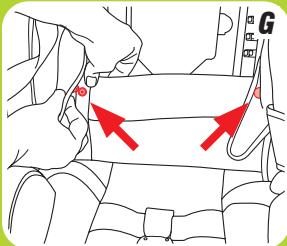

G. Unsnap Bottom Seat Pad

Undo the 2 lower snaps.

H. Pull Bottom Seat Pad Back To Expose the Plastic Shell

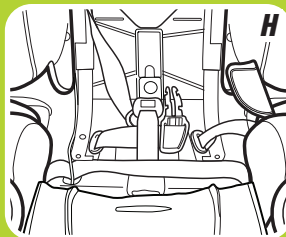

I. Open the Harness Storage Door

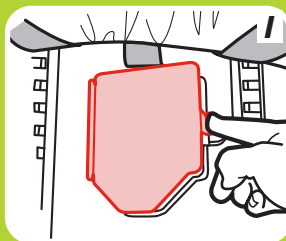

J. Place Harness, Chest Clip, Buckle Tongues, Harness Covers Inside Storage Compartment, and Close the Door

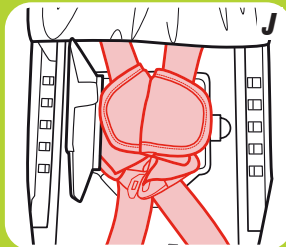
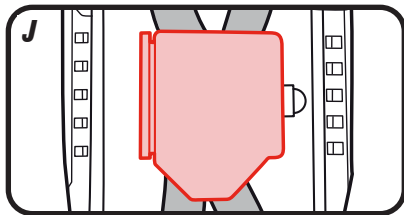

5 Booster



5 Booster

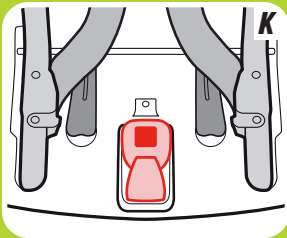

K. Store Buckle inside the groove in the car seat shell as shown

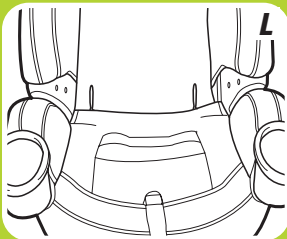

L. Replace Seat Pad

Move the headrest back to its proper position for your child.

2. Adjust the Car Seat

Place the car seat in the 6th recline position.

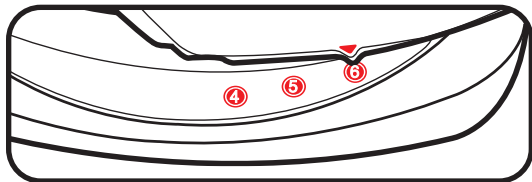

3. Place the Booster Seat Forward-Facing in the Back Seat of Vehicle

Place forward-facing on a vehicle seat that has a lap/shoulder seat belt. The base should sit as flat as possible on the vehicle seat.

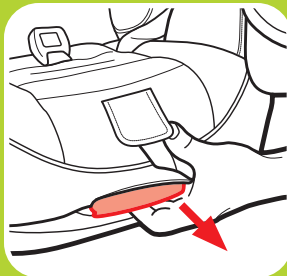

5 Booster



5 Booster

Graco allows the securing of the car seat with LATCH in the booster mode. The child still **MUST BE SECURED** with the vehicle lap/shoulder seat belt. LATCH can be used in the booster mode regardless of the weight of the child up to 100 lb (45 kg).

Verify the following before using LATCH in the booster mode:

- The lower anchor connectors **DO NOT** interfere with any vehicle seat belts or buckles.

If the lower anchor strap interferes with the vehicle seat belts or if the chosen seating position does not have lower anchors, you **MUST** store the lower anchor strap. Store the lower anchor strap by pushing in on the red buttons on the connectors and attach to the plastic bar as shown. Store the tether strap as shown.

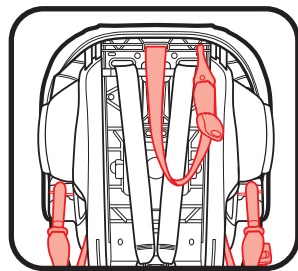

Skip to Step 10 if Not Using LATCH

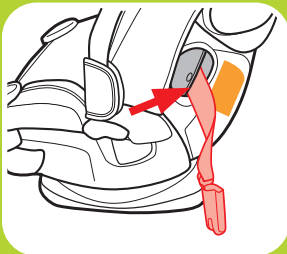

4. Make Sure Lower Anchor Strap is in the Forward-Facing Belt Path Marked with Orange Label

Continue to next step if correct. See section 4 if it is not.

5. Unhook Tether Strap From Storage Location and Lay it in the Seat

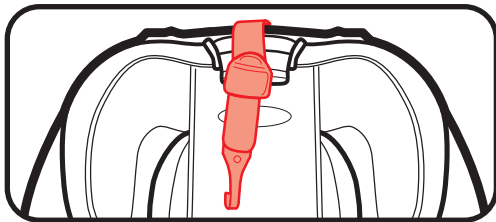

6. Attach Lower Anchor Connector to Vehicle's Lower Anchors.

Lower anchor strap should not be twisted.

Lower anchor attachment can only be used if the vehicle lower anchor spacing is 11" (28 cm) from the center of one lower anchor to the center of the other lower anchor.

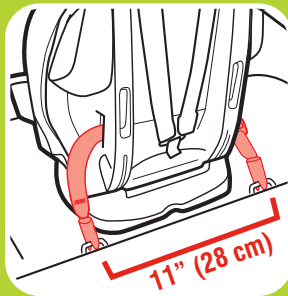
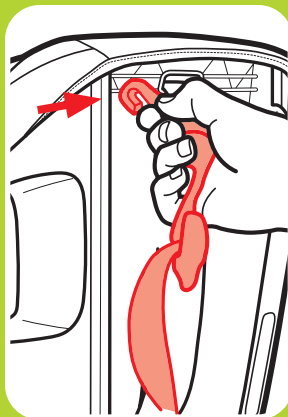
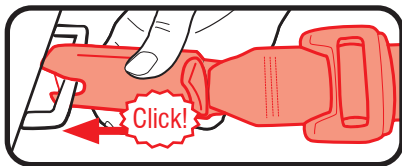

5 Booster



5 Booster

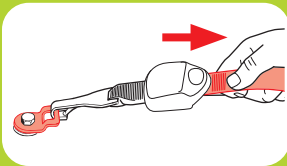
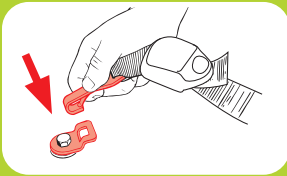
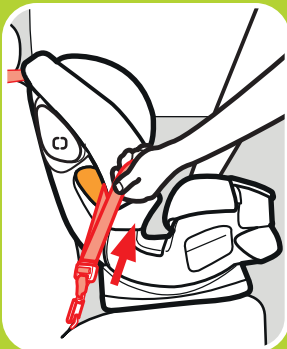

7. Remove all the slack from the lower anchor strap.

8. Attach Tether Strap

Extend the tether by lifting up on the tether lock and attach.

Consult vehicle's owner manual for specific location.

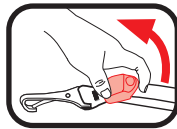

9. Tighten Tether Strap

Remove all the slack.

10. Thread the Vehicle Seat Shoulder Belt Through Seat Belt Guide on the Headrest

See section 6-B to secure your child.

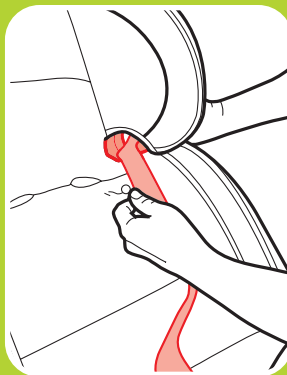

**5
Booster**

5-C Install Backless Booster

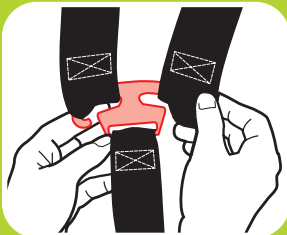
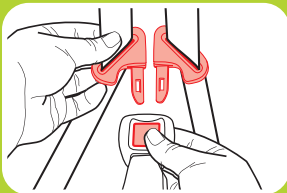
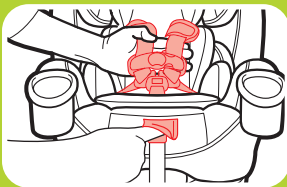

1. Remove the Seat Back by First Loosening the Harness Straps

Push down on the harness release lever while pulling out on the harness straps at the chest clip.

Unbuckle the chest clip and the buckle strap.

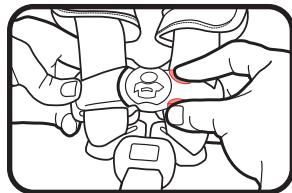

2. Remove Harness Straps from Splitter Plate

3. Make Sure Lower Anchor Straps are in the Forward-Facing Belt Path and in the Stored Position

See section 7 to change positions.

4. Unsnap Bottom Seat Pad

Unsnap seat pad and expose the bottom of seat base.

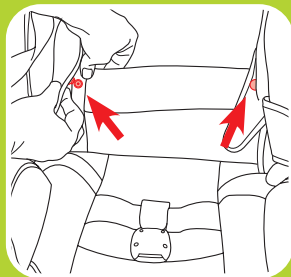
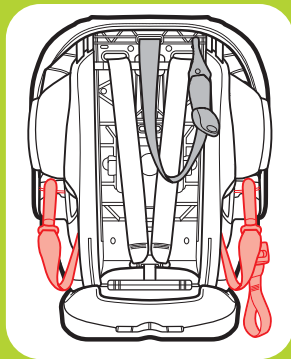

5 Booster



5 Booster

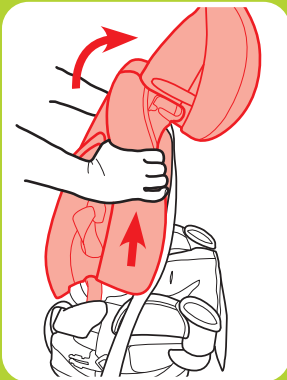
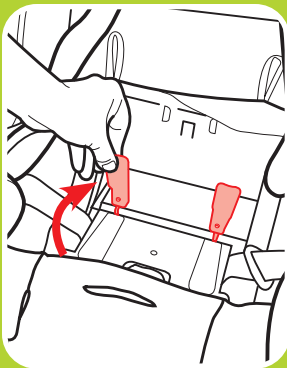

5. Lift the Red Backrest Lock Up

With the car seat in the 6th recline position, lift the red backrest locks up, and slide together.

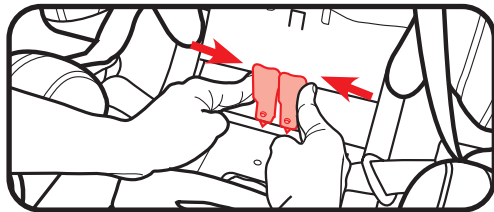

6. Remove Seat Back from Seat Base

Push the seat back up, and lift out of base. To replace the seat back, reverse steps 4 through 6.

7. **Relock the Red Backrest Locks**

Make sure they are both flat and locked into place

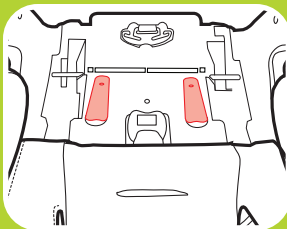

8. **Store Splitter Plate**

Pull the harness adjustment strap all the way out, and then store the splitter plate.

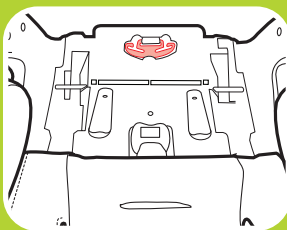

9. **Store Buckle Strap**

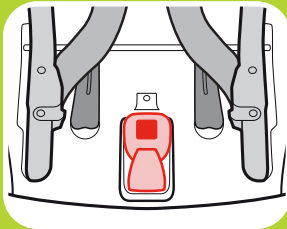

5 Booster



5 Booster

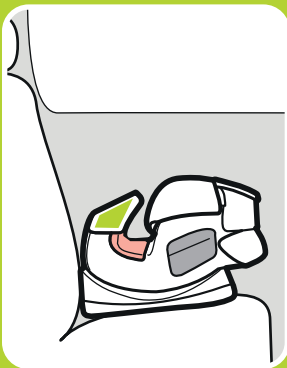
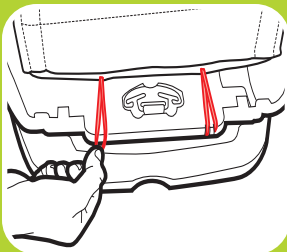

10. Attach Base Pad to the Back of Base

Attach the elastic straps onto base as shown.

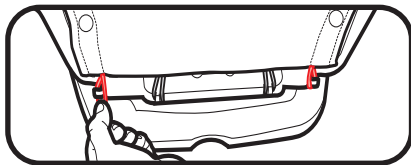

11. Place the Booster Seat Forward-Facing in the Back Seat of Vehicle

Place forward-facing on a vehicle seat that has a lap/shoulder seat belt. The base should sit as flat as possible on the vehicle seat.

See section 6-C to secure your child.

!WARNING!

WARNING! In cold weather, do not put snowsuits or bulky garments on your child when placing them in the car seat. Bulky clothing can prevent the harness straps from being tightened properly. To keep child warm, buckle your child in the car seat and place a blanket around the child, or place the child's coat on backwards after buckling in.



6-A Securing Child 5-Point Harness

1. Loosen Harness Straps

(A) Push down on the harness release lever while pulling out on the harness straps at the chest clip.

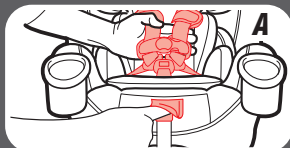

(B) Unbuckle the chest clip and the buckle. **(C)** Place harness straps off to the sides.

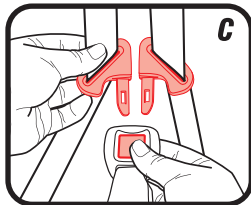

65

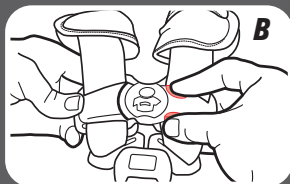

**6 Securing
Child**

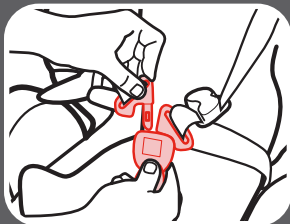
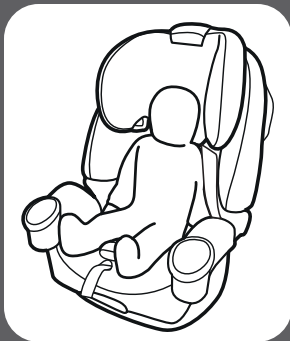

2. Place Your Child in the Seat

Make sure their back is flat against the car seat back.

3. Place Harness Straps Over Child's Shoulders and Buckle

You will hear a “click” when buckle tongues are securely attached. Pull up on each buckle tongue to make sure it is securely attached.

4. Be Sure the Harness Straps Are at the Proper Height

Rear-Facing: Harness straps must be **at or just below** the child's shoulders and top of head **must be at least 1" (2.5 cm) below** the red headrest/harness adjustment handle.

Forward-Facing: Harness straps must be **just above** the child's shoulders and top of child's ears must be **below** top of headrest. Remove the headrest and body support.

5. To Raise or Lower Headrest/Harness Adjustment Lever

Squeeze the adjustment lever and lift or lower headrest for the proper harness height.

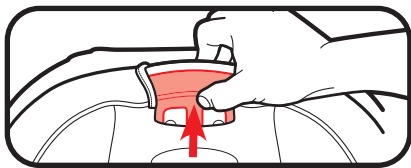

Rear-Facing



Forward-Facing

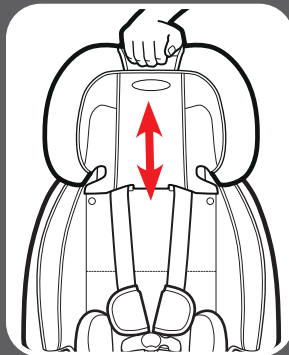

6 Securing
Child

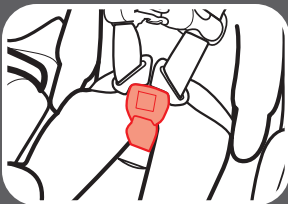

6. Check the Buckle Position

The correct slot is the one that is closest to your child without being underneath your child.

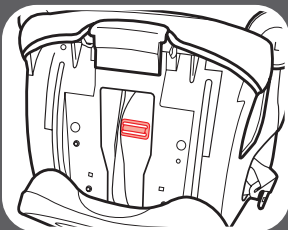

7. To Adjust Buckle Strap

Recline the car seat, and locate the metal retainer under the car seat shell.



8. Rotate Metal Retainer and Insert It Up Through the Shell and Pad

From the top of the car seat, pull the buckle out.

9. Insert Metal Retainer in the New Buckle Strap Slot

Reach underneath the car seat and pull the metal retainer through.

10. Pull Up on Buckle Strap to Make Sure it is Secured

Rear-Facing: Make sure the lower anchor strap is in front of the buckle strap when the buckle is in the inner-most position (A), and in behind when in the outter-most position (B) and that it is flat and is not twisted.

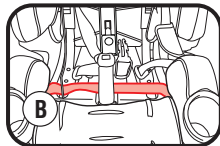
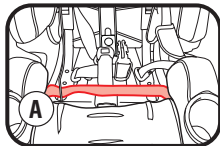

Forward-Facing: Make sure the lower anchor strap is routed behind the harness strap, is flat, and is not twisted.

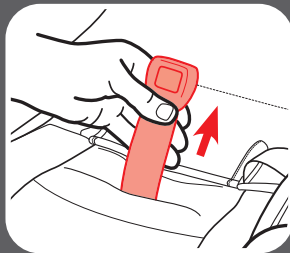
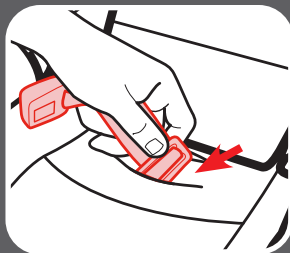

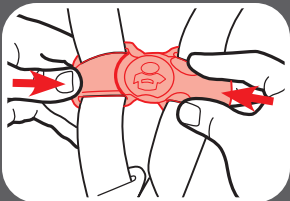

11. Buckle the Chest Clip

You will hear a “click” when the chest clip is securely buckled.

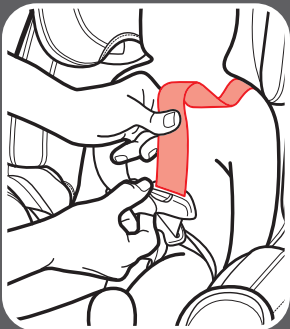

12. Pull All the Slack Out From Around the Waist

Pull up on the harness strap while pushing the chest clip down. Do this to both sides.

13. Tighten the Harness by Pulling the Harness Adjustment Strap

When you are not able to pinch any of the harness webbing at your child's shoulder, the harness is tight enough.

A snug harness should not allow any slack. It lies in a relatively straight line without sagging. It does not press on the child's flesh or push the child's body into an unnatural position.

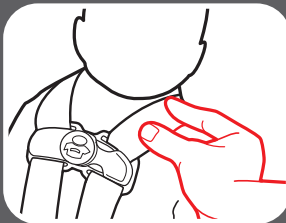
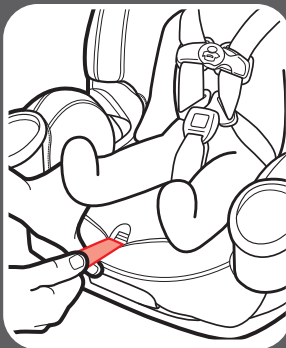

**6 Securing
Child**

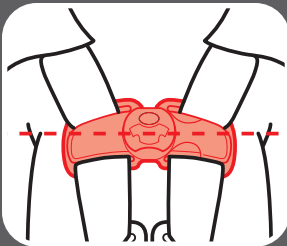

14. Raise the Chest Clip to Child's Armpit Level

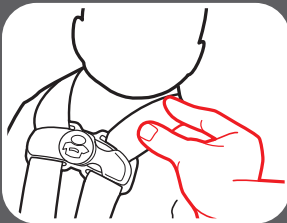

15. Check Tightness Again, Tighten More if Needed

6-B Securing Child Backed Booster

⚠️ WARNING!

WARNING! Use only the vehicle lap and shoulder belt system when restraining the child in the booster seat.

1. Place Child In Seat

Have your child sit in the booster seat, with his/her back flat against the back of the booster seat.

2. Thread Vehicle's Shoulder Belt Into Seat Belt Guide in the Headrest

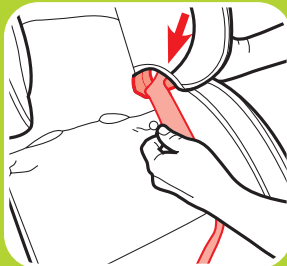
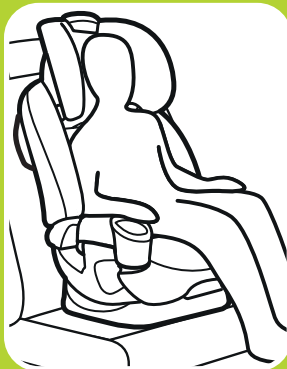

6 Securing
Child

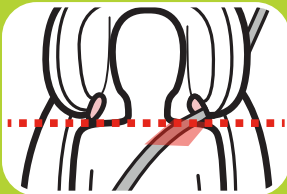
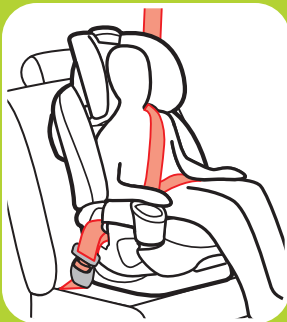

3. Buckle the Vehicle Lap/Shoulder Seat Belt

Be sure the lap portion of the vehicle seat belt goes behind the armrests.

Be sure the lap portion of the vehicle seat belt lies low across your child's hips.

Be sure the shoulder belt lies across your child's shoulders, between the neck and edge of shoulder. The belt guides should be even with or just above the shoulders.

Is Everything Correct?

Never Use Lap Belt Only



Lap Belt Behind Armrest and Lies Low Across Hips and Thighs



Shoulder Belt Lies On the Shoulder, Between the Neck and Edge of Shoulders



**6 Securing
Child**

6-C Securing Child Backless Booster

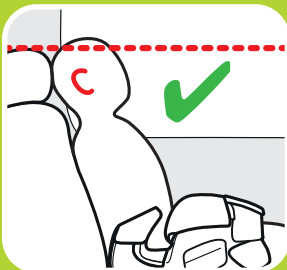
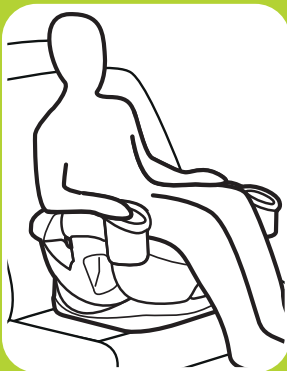

!WARNING!

WARNING! Use only the vehicle lap and shoulder belt system when restraining the child in the booster seat.

1. Place Child In Seat

Have your child sit in the booster seat, with his/her back flat against the back of the vehicle seat.

2. Ears Must Be Below the Top of the Vehicle Seat Back or Headrest.

3. Buckle the Vehicle Lap/Shoulder Seat Belt

Be sure the lap portion of the vehicle seat belt goes behind the armrests.

Be sure the lap portion of the vehicle seat belt lies low across your child's hips.

Be sure the shoulder belt lies across your child's shoulders, between the neck and edge of shoulder.

You may need to use the belt positioning clip to help get a good fit.

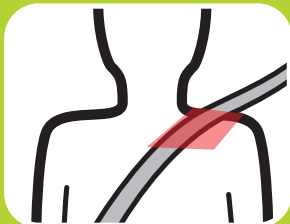
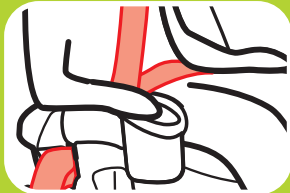

**6 Securing
Child**

Is Everything Correct?



Never Use Lap Belt Only



Lap Belt Behind Armrest and Lies Low Across Hips and Thighs



Shoulder Belt Lies On the Shoulder, Between the Neck and Edge of Shoulders

Using Belt Positioning Clip

1. Make Sure Vehicle's Seat Shoulder Belt Lays in the Red Zone As Shown

If the vehicle's seat shoulder belt lays outside this zone, you **MUST** use the belt positioning clip.

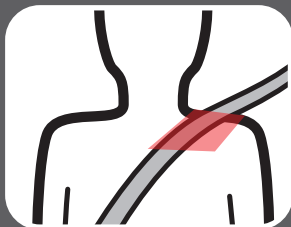

2. Attach Belt Positioning Clip

Insert the loop end of the strap through the same slot as the harness adjustment strap as shown.

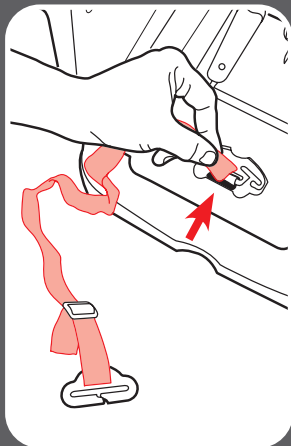

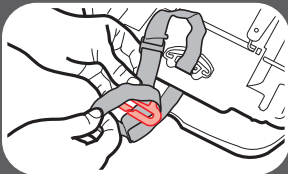

6 Securing
Child

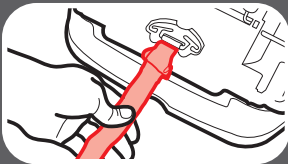

3. Push Clip and Strap Through Loop

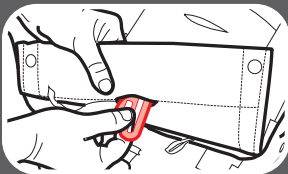

4. Pull to Tighten Strap



5. Push Clip Through Slot In Pad

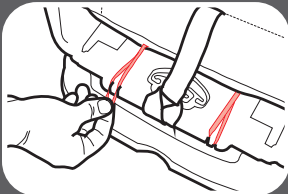

6. Attach Seat Pad to Base

7. Place Child in Seat, Buckle Child In Seat and Attach Belt Positioning Clip

With child's back flat against the back of the vehicle seat, buckle child in. Then slide the clip onto the vehicle's seat shoulder belt as shown.

8. Adjust the Belt Positioning Clip to Fit Your Child

Lengthen or shorten the belt length as shown.

Clip should fit right at the top of shoulder as shown.

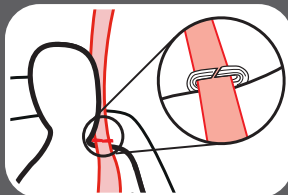
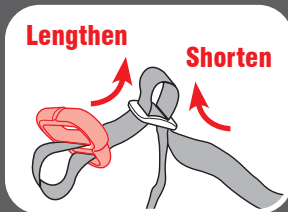
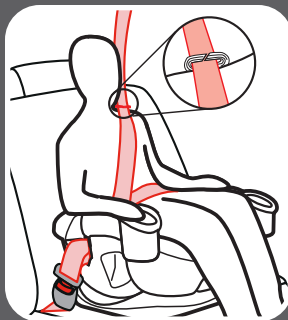

6 Securing
Child

7-A Moving the Lower Anchor Strap

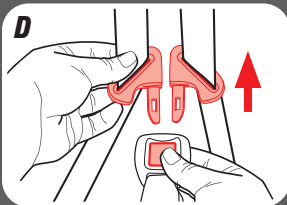
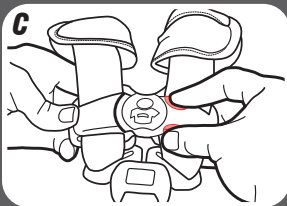
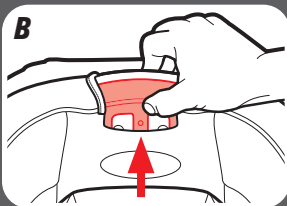

1. For Ease of Moving the Lower Anchor Strap

- A.** Loosen the harness straps.
- B.** Raise the headrest to the highest position.
- C.** Unbuckle the chest clip.
- D.** Unbuckle the buckle.

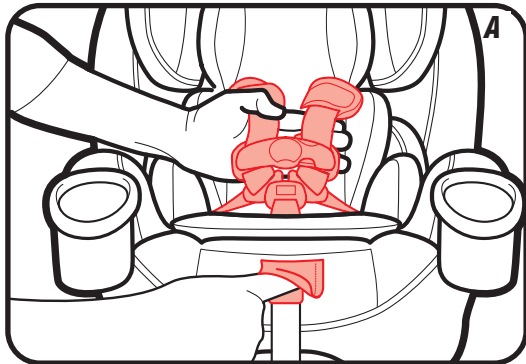

2. *Unsnap Bottom Seat Pad to Expose the Lower Anchor Strap*

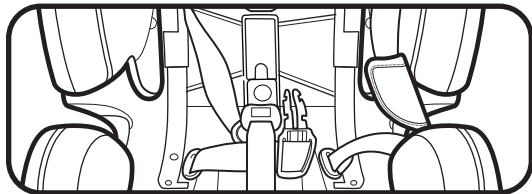

3. *Pull Lower Anchor Connectors Out of the Belt Path Openings into the Center of the Car Seat*

4. *Slide Entire Lower Anchor Strap Along Bar to the Desired Belt Path Openings*

Rear-Facing: Slide lower anchor strap along bar to the front of the seat.

Forward-Facing: Slide the lower anchor strap up along bar to the top.

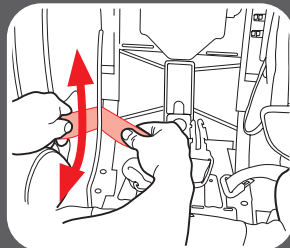
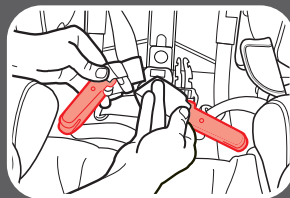
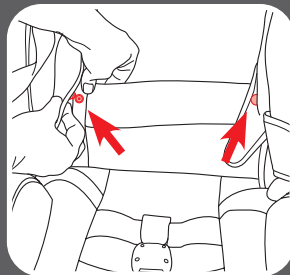

7 Moving
Lower Anchor
Attachment

7 Moving Lower Anchor Attachment

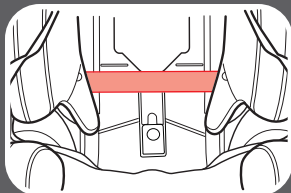
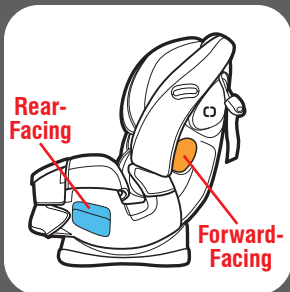

5. Push the Lower Anchor Connectors Out Through the Desired Belt Path Openings on Each Side of Car Seat

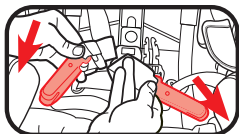

Rear-Facing: Make sure the lower anchor strap is in front of the buckle strap when the buckle is in the inner-most position (A), and in behind when in the outer-most position (B) and that it is flat and is not twisted.

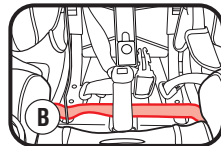
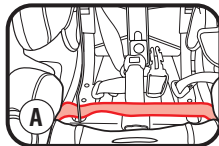

Forward-Facing: Make sure the lower anchor strap is routed behind the harness strap, is flat, and is not twisted.

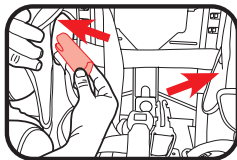

6. Replace Seat Pad

7. Move the Headrest to Its Proper Position for Your Child

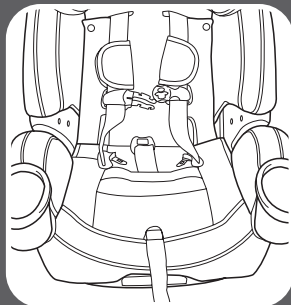

**7 Moving
Lower Anchor
Attachment**

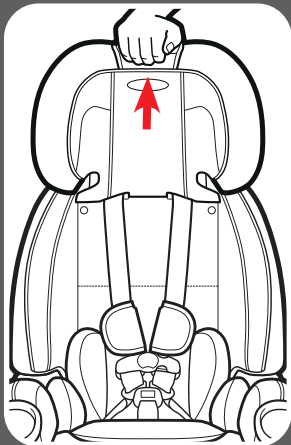

8-A Accessories *(on select models)*

!WARNING!

To prevent ejection in sudden stop or crash: The infant head support and body support can be used only for children weighing 20 lb (9 kg) or less.

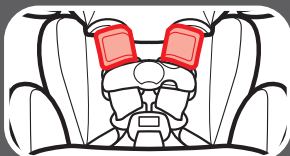

Harness Covers

Make sure that harness covers do not interfere with placement of the chest clip at armpit level.

To remove, undo the fastening strips and remove.

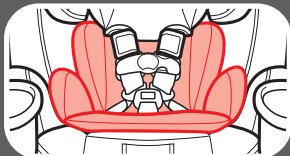

Body Support

Use only in the rear-facing mode.

Body support must be used if shoulders are below the lowest harness setting.

Never allow body support to bunch or fold behind child.

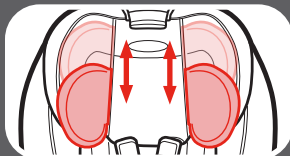

Head Support

Use only in the rear-facing mode. Head support must be used if shoulders are below the lowest harness setting. Do not use without the body support.

To adjust the support, pull up until desired height.

To remove, slide the head support out from the headrest.

9-A How to Uninstall Lower Anchor Connectors and Tether

Lower Anchor Connectors

To remove the lower anchor connectors from the lower anchors, push in on the red buttons, and pull them off.



Tether

To remove, lift up on the tether lock to release the tension.

Press in on the hook's spring. Push tether hook in, then lift up, and pull away from tether anchor.

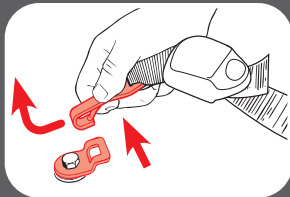
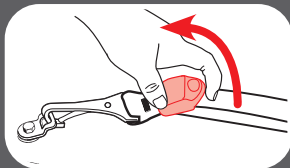

9-B Which Installation Method Should I use?

This car seat can be installed in your vehicle using either the vehicle seat belt **OR** the lower anchor attachment. Both are equally safe to use. **INSTALL USING ONLY ONE METHOD.**

Vehicle Seat Belt: Review this section and your vehicle owner's manual to learn how to install your car seat with the vehicle seat belts.

LATCH or Lower Anchor Attachment: The LATCH system or lower anchor attachment allows you to securely attach your safety seat in your car without using the vehicle seat belt and possibly to get a better fit. All 2003 and newer model year vehicles are required to have a LATCH system, although some manufacturers began including LATCH earlier. Some vehicle owner manuals use the term ISOFIX to identify the LATCH system. **Review your vehicle's owner manual for exact location and use.**



Vehicle's Tether Anchor

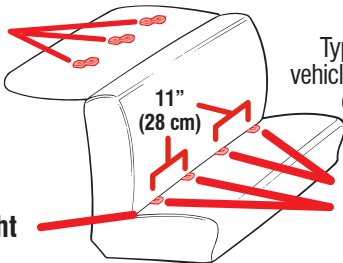

Vehicle Seat Belt

Typical seat in a passenger vehicle. Locations may vary from one vehicle to another.

Vehicle's Lower Anchor



9-C Choosing Vehicle Seat Location

Review your vehicle's owner manual for Seating Locations

The best seating location for this car seat is one that:

- Is recommended by your vehicle owner's manual, and
- Results in a secure installation of this car seat

In the event there is no available back seat and / or you have no other option than to place a child other than an infant in a rear-facing car seat in a front passenger seating position, the National Highway Traffic Safety Administration (NHTSA) recommends that you take the following steps:

- Ensure the child is properly restrained according to their age and size
- Move the seat as far back as possible
- Make sure the child is not leaning out of position, such as leaning forward into the deployment path of the air bag
- Set the air bag ON-OFF switch, if available, to the OFF position
- Move the seat as far back as possible

9-D Unsafe Vehicle Seat Location

Never install this car seat in any of the following vehicle seating locations:



rear-facing or side-facing vehicle seats



rear-facing with an active front air bag



booster mode with vehicle lap belt only seat belt

9-E Vehicle Seat Belts

Review your vehicle's owner manual for vehicle seat belt use

This car seat can be installed using a vehicle seat belt. To do this, you will need to change the seat belt to a locked mode for use with car seats. With some vehicle seat belts, this is done with the latchplate; with other vehicle seat belts, this is done with the retractor.

Vehicle Seat Belt Terms

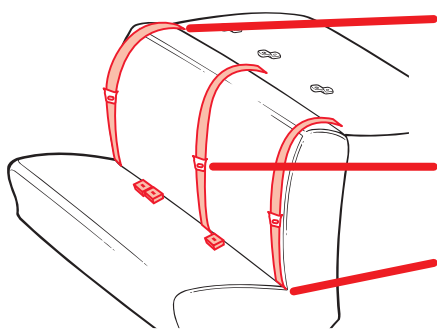

Retractor

A device that winds up the unused vehicle seat belt. It is often hidden inside the panels on the walls of the vehicle or in the vehicle seatback.

Latch Plate

The male end of the seat belt with the silver tongue.

Seat Bight

The crease where the vehicle seat back and seat bottom meet.

Identify Your Seat Belt Type

There are two different types of vehicle seat belts that can be used with this car seat:

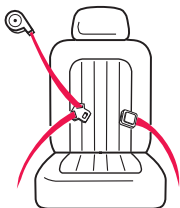

Lap/Shoulder Belt

3 connection points. Can be used in all car seats modes of use.

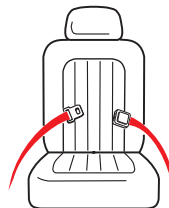

Lap Belt Only

2 connection points. **Can ONLY be used in harness mode.**

The following types of vehicle seat belts **CANNOT** be used safely with this car seat:



Lap Belt with Motorized
Shoulder Belt



Lap Belt or Shoulder
Belt Mounted on Door



Belts Forward of the
Seat Bight

Lap/Shoulder Belt Installation - Rear-Facing/Forward Facing Modes

Always review your vehicle owner's manual for specific information about your vehicle seat belts.

Most vehicles manufactured after 1996 will have Switchable retractors in the back seat. If you have any questions about your retractor type, consult your vehicle owner's manual, call Graco or visit www.gracobaby.com/vehicle-seatbelt-information.

To verify you have a Switchable retractor, **slowly** pull the belt all the way out, and then allow it to retract several inches. Try to pull the belt all the way out again. If it cannot be pulled out, it is **Switchable** retractor. Follow the steps in the rear-facing/forward-facing sections in this manual.

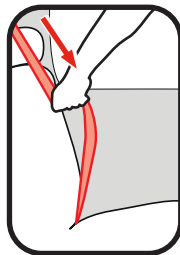

10-A Cleaning Seat Pad

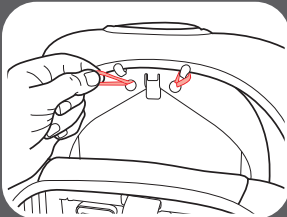
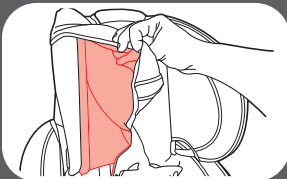
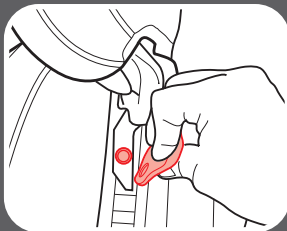

Refer to seat pad care tag for washing instructions.

Headrest Pad

Clean with a damp sponge using mild soap and cool water. If needed, pad may be removed for cleaning.

To remove, unsnap headrest pad from plastic shell.

Undo the 2 elastic straps from the back of headrest, and remove the pad. Slide the elastic retaining loops out of the belts guides.

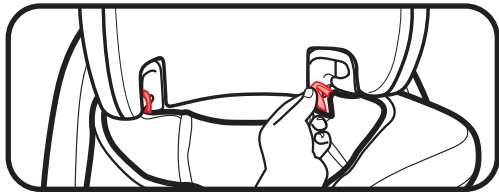

Machine wash pad in cold water on delicate cycle and drip-dry. DO NOT USE BLEACH.

Reverse the steps to reattach the pad on the headrest.

Seat Pad

Clean with a damp sponge using mild soap and cool water. If needed, cover may be removed for cleaning.

To remove, Undo elastic straps behind seat. Unsnap base pad from side pad. Undo the elastic straps in the rear-facing belt path. Pull plastic tab out of armrest. Undo the 2 elastic straps by the recline handle.

Machine wash pad in cold water on delicate cycle and drip-dry. DO NOT USE BLEACH.

Reverse the steps to reattach the pad to the shell.

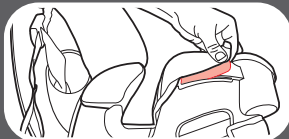
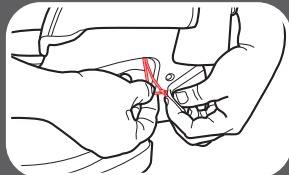
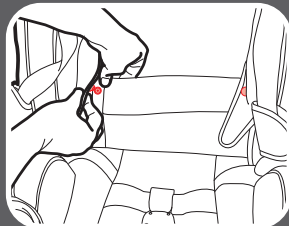
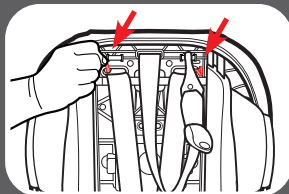
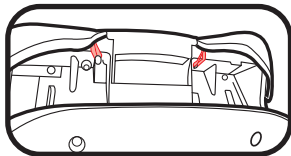

10-B Cleaning Buckle Strap

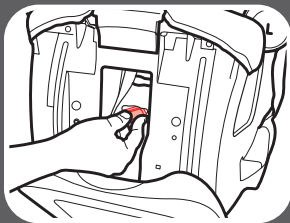
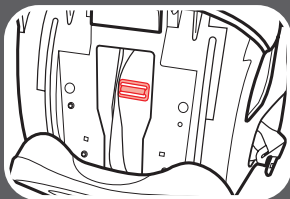

Recline the car seat and locate the metal retainer. Rotate the metal retainer up through the shell and pad. From the front, pull the buckle strap out.

To clean buckle, place in a cup of warm water and gently agitate the buckle. Press the red button several times while in the water.

DO NOT SUBMERGE THE BUCKLE STRAP. DO NOT USE SOAPS, HOUSEHOLD DETERGENTS or LUBRICANTS.

Shake out excess water and allow to air dry. Repeat steps as needed until it fastens with a click. Re-insert the buckle into the same slot it was removed. Pull up on buckle strap to make sure it is secured.

WARNING! Inspect and clean buckle from time to time to remove any objects or debris that could prevent latching.

10-C Cleaning Harness, Lower Anchor Attachment and Tether Straps

Surface wash only with mild soap and damp cloth. **DO NOT IMMERSE THE HARNESS STRAPS, LOWER ANCHOR STRAP, or TETHER STRAP IN WATER.** Doing so may weaken the straps.

If harness straps, lower anchor strap or tether strap are frayed or heavily soiled, contact Customer Service at www.gracobaby.com or 1-800-345-4109.

10 Care &
Cleaning

Notes

Notes

Replacement Parts

To purchase parts or accessories in the United States,
please contact us at the following:

www.gracobaby.com

or

1-800-345-4109



Store instruction manual in
the slot with the instruction
book icon as shown.

