



Nautilus[®] 2.0

3-in-1 Forward-Facing Harness Booster

Read This Instruction Manual



Scan the
code or visit
gracobaby.com
to view
installation
videos.

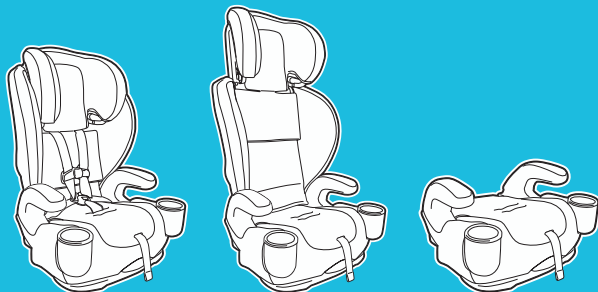

NWL0001666149B 9/24

Do not install or use this child restraint until you read and understand the instructions in this manual.

FAILURE TO PROPERLY USE THIS CHILD RESTRAINT INCREASES THE RISK OF SERIOUS INJURY OR DEATH IN A SUDDEN STOP OR CRASH.

1 Important

Pages 4-15

- 1-A **Welcome to the Graco Family**
 - If You Need Help
 - Car Seat Assembly
 - Install Cup Holders
 - Register This Child Restraint
- 1-B **Safety Warnings**
- 1-C **Right Mode of Use**
- 1-D **Aircraft Installation**

2 Features

Pages 16-19

3 Forward-Facing

Pages 20-28

- 3-A **Forward-Facing Use**
- 3-B **Install Forward-Facing with LATCH**
- 3-C **Install Forward-Facing with the Vehicle Seat Belt**

4 Securing Child

Pages 29-35

- 4-A **Securing Child 5-Point Harness**

5 Booster

Pages 36-56

- 5-A Booster Use**
- 5-B Install Highback Booster**
- 5-C Install Backless Booster**
- 5-D Securing Child Highback Booster**
- 5-E Securing Child Backless Booster**

6 Additional Information

Pages 57-63

- 6-A How to Uninstall Lower Anchor Connectors and Tether**
- 6-B Which Installation Method Should I use?**
- 6-C Choosing Vehicle Seat Location**
- 6-D Unsafe Vehicle Seat Location**
- 6-E Vehicle Seat Belts**

7 Care & Cleaning

Pages 64-70

- 7-A Cleaning Seat Pad**
- 7-B Cleaning Buckle**
- 7-C Cleaning Harness, Lower Anchor Attachment and Tether**



1 Important

1

1-A Welcome to the Graco Family!

Your child's safety depends on you. **No car seat can guarantee protection from injury in every situation, but proper use helps reduce the risk of serious injury or death. READ THIS MANUAL CAREFULLY.**

This child restraint meets or exceeds all applicable requirements of Federal motor vehicle safety standard 213 for use in motor vehicles.

Even if this car seat seems easy to figure out on your own, you must follow the detailed instructions in this instruction manual to ensure the steps below are performed correctly.

If You Need Help

In the U.S.A, please contact our Customer Service Department with any questions you may have concerning parts, use, or maintenance. When you contact us, please have your product's model number and date of manufacture ready so that we may help you efficiently. These numbers can be found on a sticker on the bottom of your car seat.

Contact us at www.gracobaby.com or call **1-800-345-4109**.

For additional resources or to get your car seat checked by a child passenger safety technician, please visit the following web sites:

www.nhtsa.gov • www.seatcheck.org • www.safekids.org

This car seat is for children: *Forward-Facing: 26.5-65 lb (12-30 kg)*
Highback Booster: 40-100 lb (18.1-45 kg)
Backless Booster: 40-120 lb (18.1-54 kg)

Car Seat Assembly (On Select Models)
(Follow the directions that matches your model)

Adult Assembly Required

Before you begin, **Make Sure** the harness straps are securely attached within the “T”-shaped slots around the arms as shown.

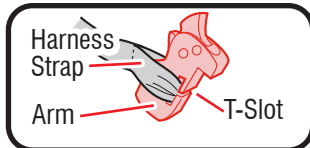
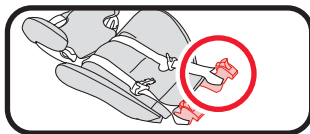

Slide the lower backrest into the base until it **CLICKS** into place.

Make Sure all hands, fingers and other objects are clear of the gutters.

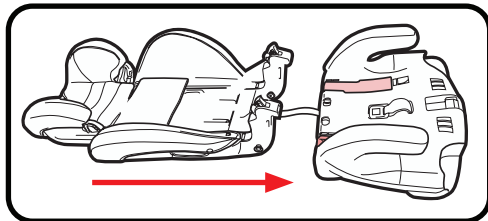

5



1 Important



1 Important

1

With your other hand, raise seat back so that both arms **LOCK** into the gutters. Arms should **CLICK** into the gutters.

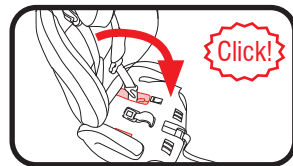
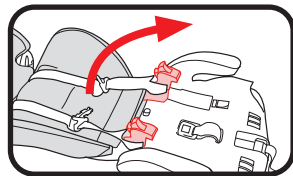

Cup holders *MUST* be installed.

Place the tab on the cupholder into the corresponding slot on the base and rotate the cup up and into position as shown. **You will hear a “CLICK” when they are secured in place.**

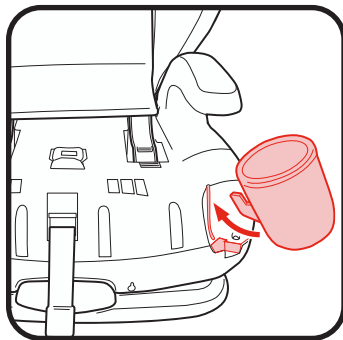

Lay the seat pad over the base and fit the pad around the cup holders.

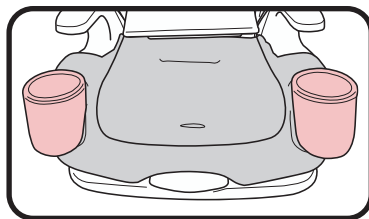

Pull the buckle up through the matching slot of the seat pad.

Thread the harness adjustment strap through the slot on the front of the seat pad.

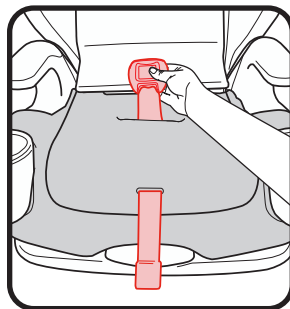

1 Important



1 Important

Attach the two snaps near the seat crease (A).

Attach the two tabs on the front of the base (B).

From the back of the base, secure the two elastic loops from the seat pad to the two hooks. Then attach the snaps on the back of each armrest (C).

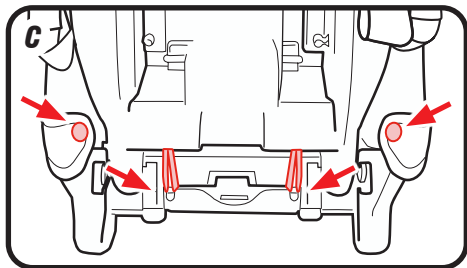
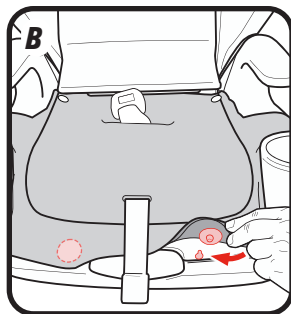
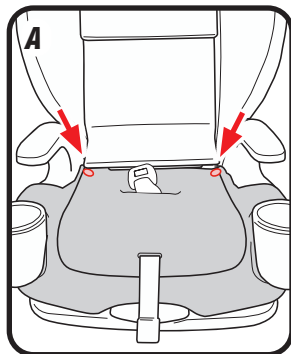

Register This Child Restraint

Please fill out the prepaid registration postcard attached to the harness and mail it in today **or register online at www.gracobaby.com/carseatregistration.**

Child restraints could be recalled for safety reasons. You must register this restraint to be reached in a recall. Send your name, address, and the restraint's model number and manufacturing date to:

Graco Children's Products, Inc.
Attn: Customer Service
P.O. Box 169, Elverson, PA 19520-9901
or call 1-800-345-4109

or register online at www.gracobaby.com/carseatregistration

For recall information, call the U.S. Government's Vehicle Safety Hotline at 1-888-327-4236 (TTY: 1-800-424-9153), or go to <http://www.NHTSA.gov>

For future reference or if you change addresses, record the model name, model number, date of manufacture and purchase date of this car seat on the below. You can find this information either on the registration card if you still have it or on the date label located on the bottom of the car seat.

Model Name _____

Model Number _____

Date of Manufacture _____

Date of Purchase _____



1 Important

1-B Safety Warnings



1 Important

!WARNING!

Failure to follow these instructions and child restraint's labels can result in child striking the vehicle's interior during a sudden stop or crash.

! According to accident statistics, children are safer when properly restrained in the rear seating positions than in the front seating positions. The center of the back seat can be the safest during a possible side impact.



- ! Review your vehicle owner's manual for more information about air bags and car seat use.**
- ! If your vehicle does not have a back seat, review your vehicle owner's manual.**
- ! Select a suitable location for the car seat in your vehicle.**
- ! When forward-facing, children should use the built-in harness system for as long as possible until they reach the maximum forward-facing weight or height for their car seat. At that point, children should ride in a belt-positioning booster seat. A booster is no longer needed once the**

vehicle seat belt fits properly, typically when they reach 4 feet 9 inches tall and are between ages 8-12. Be sure to check your local and state laws, as well as AAP and NHTSA recommendations, for car seat usage.*

- ! Secure car seat with a vehicle seat belt or LATCH that is properly routed as shown in this manual.
- ! Vehicle seat belt system **MUST** hold car seat securely. Not all vehicle seat belts can be used with a car seat.
- ! If vehicle seat belt does not hold car seat securely, read “Vehicle Seat Belts” section 6-D and your vehicle owner’s manual.
- ! Always secure car seat with lower anchor attachment or a vehicle seat belt, even when unoccupied. In a crash, an unsecured car seat can injure passengers.
- ! If car seat is in a crash, it must be replaced. **DO NOT** use it again! A crash can cause unseen damage and using it again could result in serious injury or death.
- ! **DO NOT** use car seat if it is damaged or missing parts.

*Graco Supports the American Academy of Pediatrics and National Highway Traffic Safety Administration’s Car Seat Guidelines. Visit www.gracobaby.com/en-US/safety for information on car seat usage recommendations.



1
Important



1 Important

! DO NOT use accessories or parts other than those provided by Graco except for a thin towel or mat to protect your vehicle seat. Their use could alter the performance of the car seat.

! DO NOT remove LATCH system from car seat. If using vehicle seat belt to secure car seat, lower anchor connectors must be stored.

! Never leave child unattended, even when sleeping. Child may become tangled in harness straps and suffocate or strangle.



! Never attach two lower anchor connectors to one vehicle lower anchor point unless specifically allowed by the vehicle manufacturer.

! Do not use both the vehicle seat belt and lower anchor attachment at the same time when using the car seat forward-facing with the 5-point harness.

Car Seat's Useful Life

STOP using this car seat and throw it away 10 years after the date of manufacture. Look for date of manufacture label on bottom of the car seat.

Graco Children's Products Inc. advises against loaning or passing along a car seat unless you know the complete history of the product. We also advise against purchasing a car seat second hand.

Vehicle Seat Protection

Protect vehicle seat. Use a car seat mat, towel, or thin blanket under and behind car seat.

Warm Weather Use

Car seat parts can get very hot in the sun or warm weather. **To avoid burns, always check before putting child in car seat.**



1 Important

1-C Right Mode of Use

26.5 lb
(12 kg)

40 lb
(18.1 kg)

65 lb
(30 kg)

100 lb
(45 kg)

120 lb
(54 kg)

Forward-Facing with 5-Point Harness

Must be 27-49" (69-125 cm) tall:

26.5-40 lb (12-18 kg) and can sit upright unassisted

MUST use 5-point harness. 40-65 lb (18-30 kg)

SHOULD use 5-point harness*.

Highback Booster Mode with Vehicle Lap/Shoulder Seat Belt

Must be 43-57" (110.1-145 cm) tall and 4+ years old:

40-65 lb (18.1-30 kg) **CAN** be in booster mode.

Over 65 lb (30 kg) **MUST** be in booster mode.*

Backless Booster Mode with Vehicle Lap/Shoulder Seat Belt

Must be 43-57" (110.1-145 cm) tall and 4+ years old:

40-65 lb (18.1-30 kg) **CAN** be in booster mode.

Over 100 lb (45 kg) **MUST** be in backless booster mode.*

*Check your state laws and the AAP/NHTSA recommendations. Review page 23 more for information.



1-D Aircraft Installation



This child restraint is certified for use in aircraft only when used with the internal harness system. Use only on forward-facing aircraft seats. Follow the instructions for vehicle installation and section 6-E for routing the aircraft lap belt. See section 3-C for installation but do not use the tether. See section 6-E “Vehicle Seat Belts” and the instructions below.



This car seat is NOT certified for use in aircraft when used as a booster seat because aircrafts do not have shoulder belts.

Contact the airline for their specific policies.

When installing the car seat, route the lap seat belt through the proper path and buckle it in. Then, pull on the tail of the belt so that the lap belt gets tight around the car seat.

Grab the sides of the seat at the belt path where the lap belt is and move the car seat from side-to-side and front-to-back. If it moves less than 1” (2.5 cm), it is tight enough.

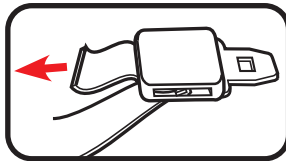

1 Important

2-A Car Seat Features

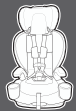

2 Features

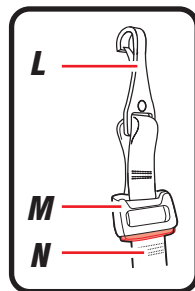
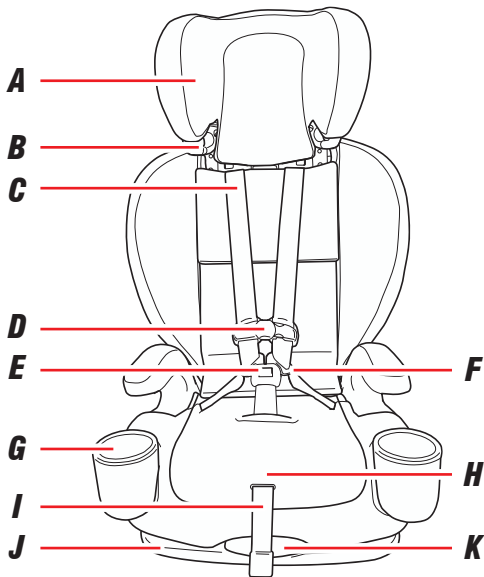

Lower Anchor Attachment

- A Headrest**
- B Booster Shoulder Belt Guide**
- C Harness Straps**
- D Chest Clip**
- E Buckle**
- F Buckle Tongues**
- G Cup Holder**
- H Harness Adjustment Lever**
(under seat pad)
- I Harness Adjustment Strap**
- J Recline Foot**
- K Recline Handle**
- L Lower Anchor Connector**
- M Lower Anchor Strap Adjuster**
- N Lower Anchor Strap**



2 Features

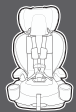

2 Features

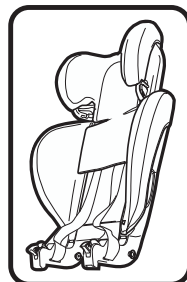
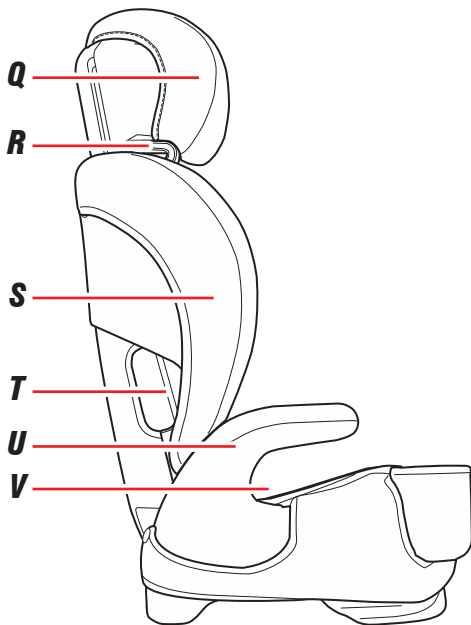

Back Support

- Q Headrest**
- R Shoulder Belt Guide**
- S Side Panel**
- T Forward-Facing Belt Path**
- U Armrest**
- V Booster Belt Guide**

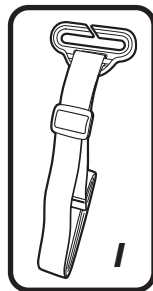
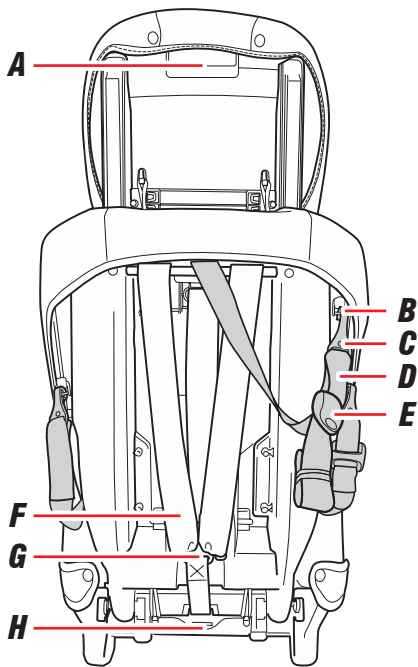

- A** *Headrest/Harness Height Adjustment Lever*
- B** *Tether Storage Bar*
- C** *Tether Hook*
- D** *Tether Strap*
- E** *Tether Strap Adjuster*
- F** *Harness Straps*
- G** *Splitter Plate*
- H** *Belt Positioning Clip Attachment Point*
- I** *Belt Positioning Clip*



2 Features



3-A Forward-Facing

3-A Forward-Facing Use



LATCH: Do not install by this method for a child weighing more than 45 lb (20 kg)

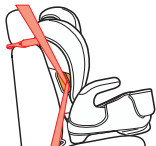

Vehicle Seat Lap/Shoulder Belt with Tether



Vehicle Seat Lap Belt with Tether

Forward-Facing Harness Mode:
26.5-65 lb (12-30 kg) and 27-49"
(69-125 cm) at least one year old



- When forward-facing, children should use the built-in harness system for as long as possible until they reach the maximum forward-facing weight or height for their car seat. At that point, children should ride in a belt-positioning booster seat. A booster is no longer needed once the vehicle seat belt fits properly, typically when they reach 4 feet 9 inches tall and are between ages 8-12. Be sure to check your local and state laws, as well as AAP and NHTSA recommendations, for car seat usage.



3-B Forward-Facing with LATCH

3-B Install Forward-Facing with LATCH

Review your vehicle owner's manual for LATCH location and use. Do not install by this method for a child weighing more than 45 lb (20 kg).

1. Remove Lower Anchor Connectors and Tether from Storage Locations

Unhook tether and lay it in the seat.

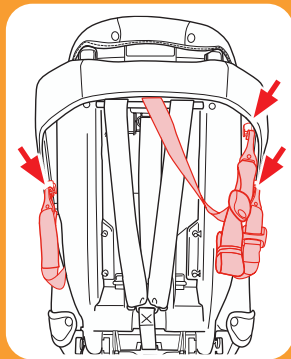
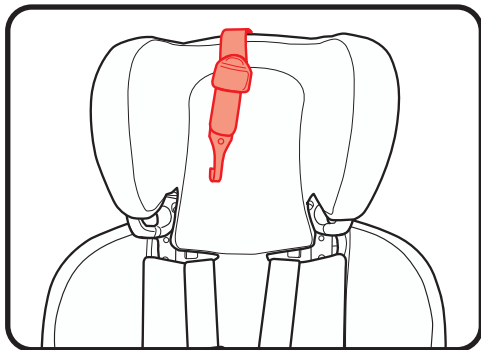

Visit www.gracobaby.com and the Graco® Nautilus® 2.0 LX 3-in-1 Harness Booster Car Seat product page to view installation videos.

 Forward-Facing
3-B
with LATCH

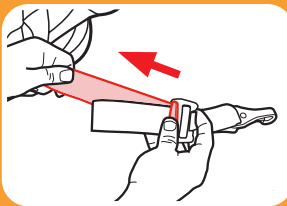
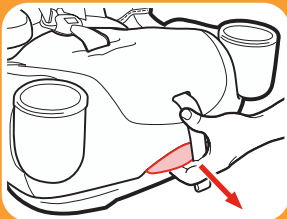
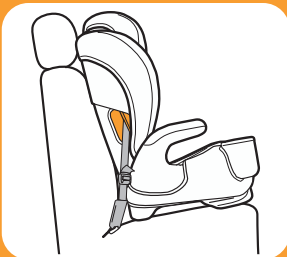

2. Place Car Seat Forward-Facing in Back Seat of the Vehicle

Place forward-facing in vehicle seat. The bottom of the seat should sit as flat as possible on the vehicle seat.

Note: Make sure base is a minimum of 80% on Vehicle Seat.

3. Choose One of the Four Recline Positions

To recline, pull recline handle out and tilt the seat back. For upright position, pull recline handle out and push down on front of seat.

4. Extend the Lower Anchor Strap.

For easier installation, extend the lower anchor strap to its maximum length by pressing the grey button and pulling on the strap.

5. Attach Lower Anchor Connectors to Vehicle's Lower Anchors

The lower anchor strap should not be twisted.

Lower anchor connectors can only be used if the vehicle lower anchor spacing is 11 inches (28 cm) from the center of one lower anchor to the center of the other lower anchor.

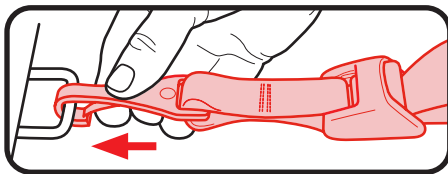

6. Tighten the Lower Anchor Strap

Press down firmly in the center of the car seat while tightening the lower anchor strap.

Do not pull on the strap with excessive force.

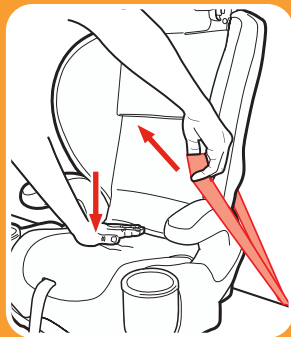
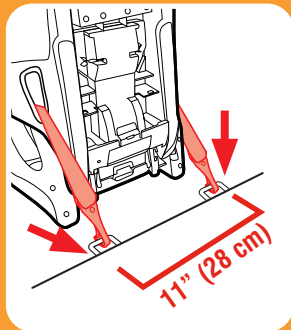

3-B
Forward-Facing
with LATCH

Forward-Facing 3-B with LATCH

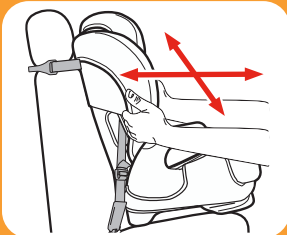
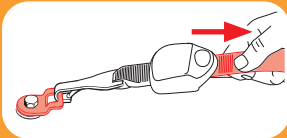
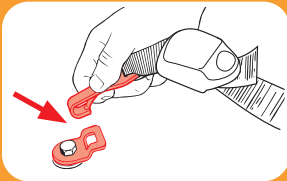
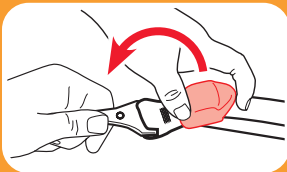

7. Attach Tether Hook

Extend the tether by lifting up on the tether lock and attach.

Consult vehicle owner's manual for specific location.

8. Tighten Tether Strap

Remove all the slack.

9. Test For Tightness

Grab the sides of the seat where the lower anchor strap is and slide the car seat side-to-side and front-to-back.

If the seat moves less than 1" (2.5 cm), it is tight enough.

See section 4-A to secure your child.

3-C Install Forward-Facing with Vehicle Seat Belt

Visit www.gracobaby.com and the Graco® Nautilus® 2.0 LX 3-in-1 Harness Booster Car Seat product page to view installation videos.

1. Store Lower Anchor Connectors

Attach lower anchor connectors to the plastic bars as shown.

2. Remove Tether Strap from Storage Location

Unhook tether and lay it on the seat.

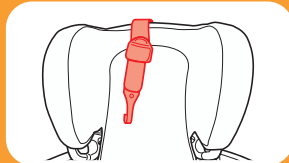
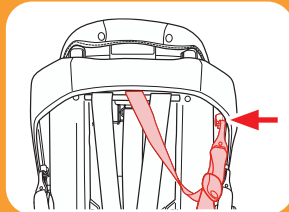
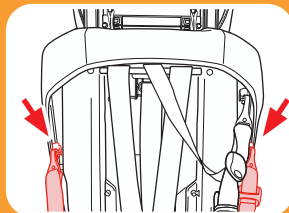

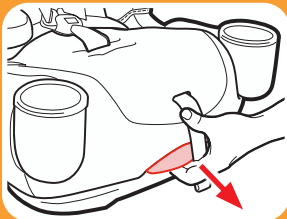

3-C
Forward-Facing
with Seat Belt

3-C Forward-Facing with Seat Belt

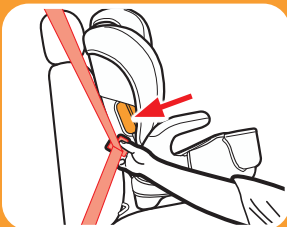

Review your vehicle owner's manual for vehicle seat belt use



3. Place Car Seat Forward-Facing in Back Seat of the Vehicle

Place forward-facing in vehicle seat. The bottom of the seat should sit as flat as possible on the vehicle seat.

Note: Make sure base is a minimum of 80% on Vehicle Seat.

4. Choose One of the Four Recline Positions

To recline, pull recline handle out and tilt the seat back. For upright position, pull recline handle out and push down on front of seat.

5. Route the Vehicle Seat Belt

Thread vehicle seat belt through the forward-facing belt path (marked with an orange label) and out the other side. Buckle it. The seat belt should lie as flat as possible and not be twisted.



3-C Forward-Facing with Seat Belt

6. Lock the Vehicle Seat Belt

In most vehicles today, slowly pull the shoulder belt all the way out and then let it go back in. You will hear a clicking sound. Slowly pull out on the belt and it should be locked. If not, review your car's owner manual and section 6-E.

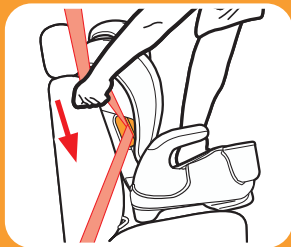

7. Tighten the Vehicle Seat Belt

Press down firmly in the center of the car seat. Pull on the shoulder belt to tighten while feeding the slack back in the retractor. Do not pull on the strap with excessive force.



3-C Forward-Facing with Seat Belt

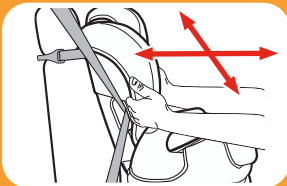
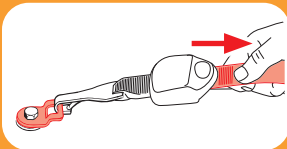
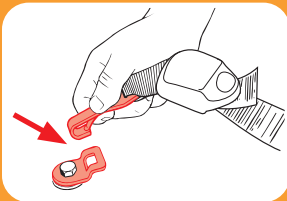
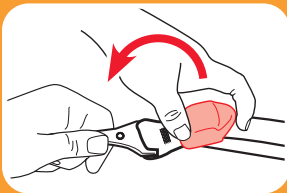

8. Attach Tether Hook

Extend the tether by lifting up on the tether lock and attach.

Consult vehicle owner's manual for specific location.

9. Tighten Tether Strap

Remove all the slack.

10. Test For Tightness

Grab the sides of the seat where the seat belt is and slide the car seat side-to-side and front-to-back.

If the seat moves less than 1" (2.5 cm), it is tight enough.

See section 4-A to secure your child.

! WARNING!

WARNING! In cold weather, do not put snowsuits or bulky garments on your child when placing them in the car seat. Bulky clothing can prevent the harness straps from being tightened properly. To keep child warm, buckle your child in the car seat and place a blanket around the child or place the child's coat on backwards after buckling in.



4 Securing Child 5-Point Harness

4-A Securing Child 5-Point Harness

1. Loosen Harness Straps

(A) Push down on the harness release lever while pulling out on the harness straps at the chest clip.

(B) Unbuckle the chest clip and the buckle strap.

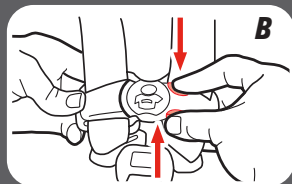

4 Securing Child 5-Point Harness

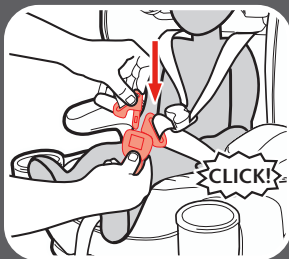
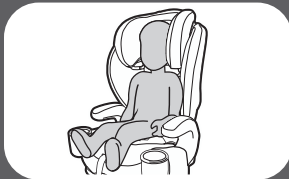
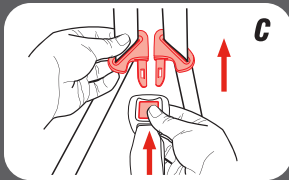

(C) Place harness straps off to the sides.

2. Place Your Child in the Seat

Make sure their back is flat against the car seat back.

3. Place Harness Straps Over Child's Shoulders and Buckle

You will hear a “click” when buckle tongues are securely attached. Pull up on each buckle tongue to make sure it is securely attached.

4. *Be Sure the Harness Straps Are at the Proper Height*

Forward-Facing: Harness straps must be **at or just above** the child's shoulders and top of child's ears must be **below** top of headrest.

5. *To Raise or Lower Headrest/Harness*

Squeeze the adjustment lever and lift or lower headrest for the proper harness height.

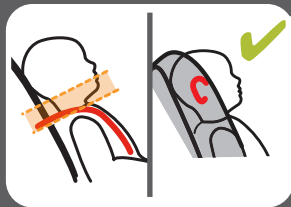
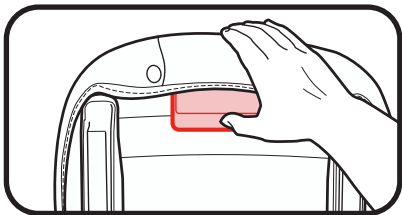

Forward-Facing

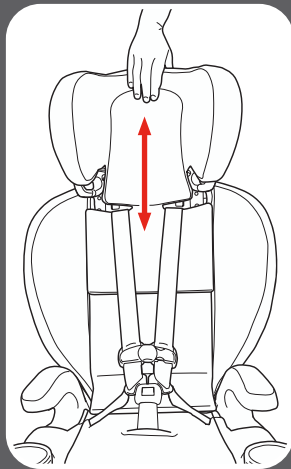

4 Securing Child 5-Point Harness

4 Securing Child 5-Point Harness

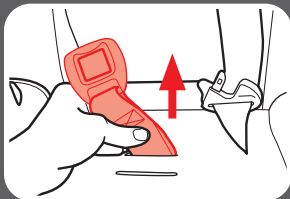
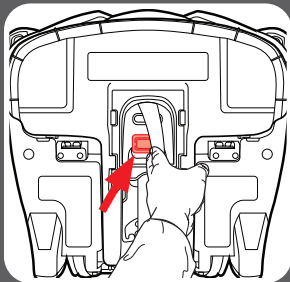
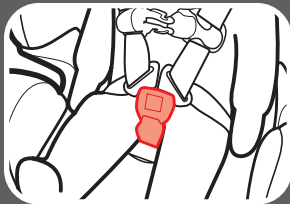

6. Check the Buckle Position

The correct slot the one that is closest to your child without being underneath your child.

7. To Adjust the Buckle Strap

From bottom of car seat, rotate metal retainer to side in order to push it through slot easier.

8. Pull buckle strap from child restraint as shown.



4 Securing Child 5-Point Harness

9. ***Insert Metal Retainer in the New Buckle Strap Slot***

Reach underneath the car seat and pull the metal retainer through.

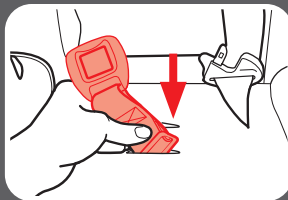

10. ***Pull Up on Buckle Strap to Make Sure it is Secured***

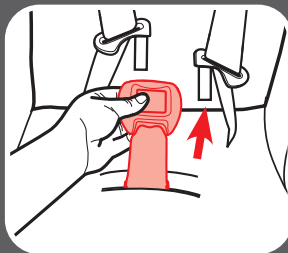

11. ***Buckle the Chest Clip***

You will hear a “click” when the chest clip is securely buckled.

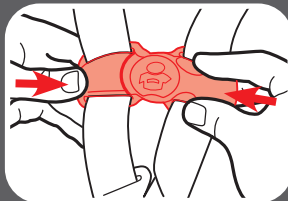

4 Securing Child 5-Point Harness

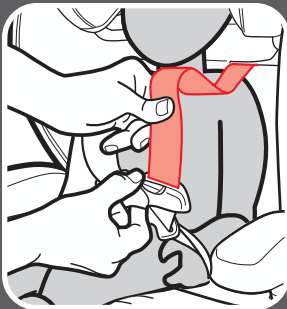

12. Pull All the Slack Out From Around the Waist

Pull up on the harness strap while pushing the chest clip down. Do this to both sides.

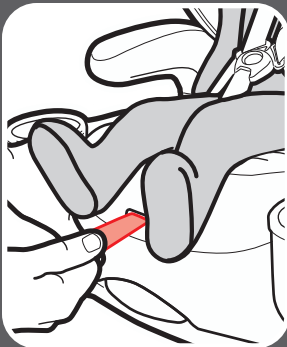

13. Tighten the Harness by Pulling the Harness Adjustment Strap

When you are not able to pinch any of the harness webbing at your child's shoulder, the harness is tight enough.

A snug harness should not allow any slack. It lies in a relatively straight line without sagging. It does not press on the child's flesh or push the child's body into an unnatural position.

14. Raise the Chest Clip to Child's Armpit Level

15. Check Tightness Again, Tighten More if Needed

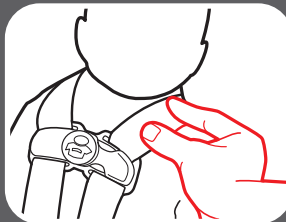
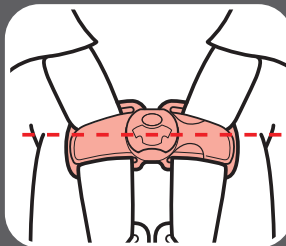
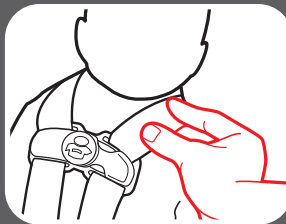

**4 Securing Child
5-Point Harness**

5-A Booster Use



**Vehicle Lap/Shoulder
Seat Belt**



**Vehicle Lap/Shoulder
Seat Belt**

Highback Booster:
40-100 lb (18.1-45 kg)
43-57" (110.1-145 cm)
at least 4 years old

Backless Booster:
40-120 lb (18.1-54 kg)
43-57" (110.1-145 cm)
at least 4 years old



- When forward-facing, children should use the built-in harness system for as long as possible until they reach the maximum forward-facing weight or height for their car seat. At that point, children should ride in a belt-positioning booster seat. A booster is no longer needed once the vehicle seat belt fits properly, typically when they reach 4 feet 9 inches (145 cm) tall and are between ages 8-12. Be sure to check your local and state laws, as well as AAP and NHTSA recommendations, for car seat usage.



5-A Booster

- **DO NOT** position vehicle shoulder belt under the child's arm or back.
- **DO NOT** allow child to slouch or slide down in the booster seat.
- **DO NOT** position vehicle belt over top of armrests.
- Vehicle's seat headrest **SHOULD NOT** create a gap between vehicle seat and booster seat.
- The front of booster seat **MUST NOT** hang over front of vehicle seat.
- If child will not keep vehicle belt properly positioned, **DO NOT** use this booster seat. Use a different car seat.

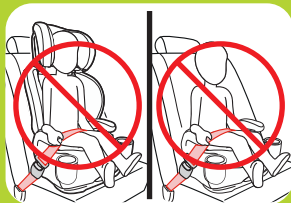

Never Use a Vehicle Lap-Only Belt Across Front of Child

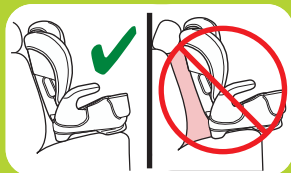

5-A Booster

5-B Install Highback Booster

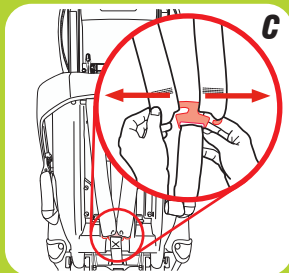
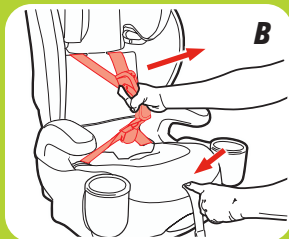
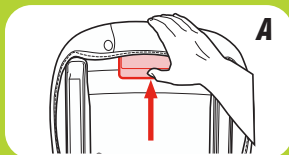

1. Store The Harness System

A. Raise the headrest to the highest position

B. Loosen Harness Straps

Push down on the harness release lever while pulling out on the harness straps.

C. With the harness system loose, from the back of the seat, remove the harness straps from the splitter plate as shown.



5-B Highback
Booster

D. Unbuckle the buckle

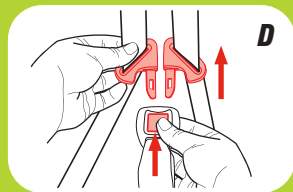

E. Remove Lower Seat Pad

To remove lower seat pad, Unhook the elastic loops and undo the snaps on the back of the seat.

Then undo the 2 snaps near the seat crease.

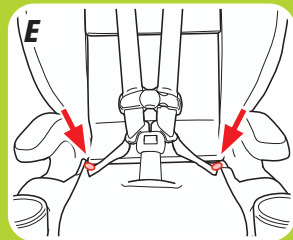
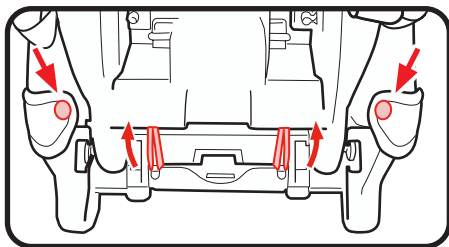

**5-B
Highback
Booster**



5-B Highback Booster

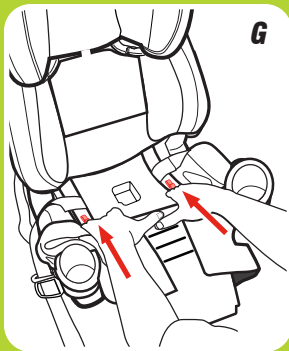

F. Store the Buckle

Lift the lower seat pad up and pull the buckle through the pad and store the buckle as shown.

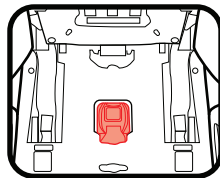

- G.** Pull the seat pad out of the way to reveal the red buttons as shown in the seating area. Slide the buttons to release the back support from the base and lower it into a flat position. Hold the back support to avoid it from falling back and hitting something.

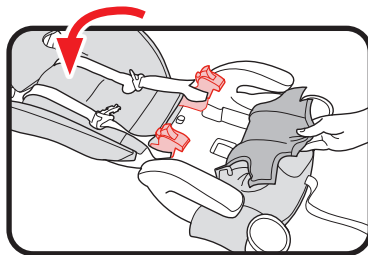

H. Remove the harness straps from the T-Slots. Store the harness straps in safe place for future use.

I. Thread the splitter plate from the back of the seat through the seat crease to the front of the seat. Store the splitter plate on the base of the seat.

J. Pull on the adjustment strap on the front of the seat to lock the splitter plate into place.

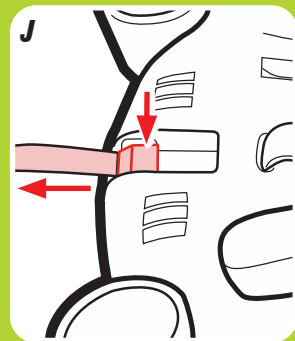
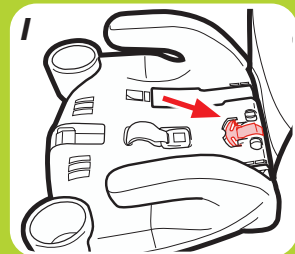

**5-B Highback
Booster**

5-B Highback Booster

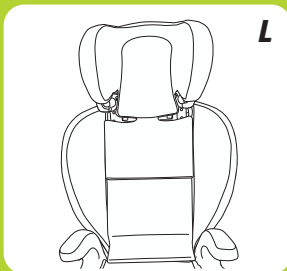
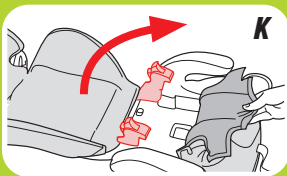

K. With the harness removed, raise seat back so that both arms **LOCK** into the gutters. Arms should **CLICK** into the gutters.

Make Sure all hands, fingers and other objects are clear of the gutters.

L. Replace the Seat Pads

Reattach the snap near the seat crease.
Reattach the 2 elastic loops to the back of the seat.

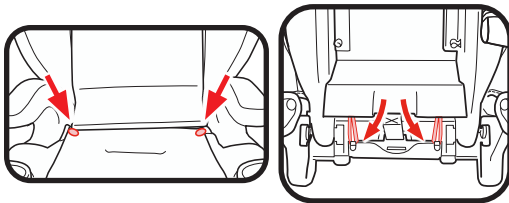

2. Place Booster Seat in the Most Upright Position

Pull the recline handle out and push down on front of seat. Put the booster seat in the most upright position.

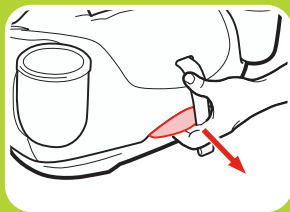

3. Place Car Seat Forward-Facing in Back Seat of the Vehicle

Place forward-facing on a vehicle seat that has a lap/shoulder seat belt. The bottom of the seat should sit as flat as possible on the vehicle seat.



**5-B Highback
Booster**



5-B Highback Booster

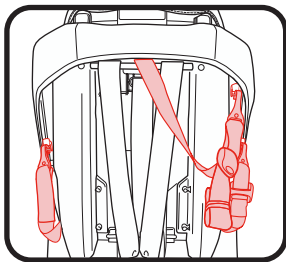

Graco allows the securing of the car seat with LATCH in the booster mode, only if the vehicle manufacturer allows it. The child still **MUST BE SECURED** with the vehicle lap/shoulder seat belt. LATCH can be used in the booster mode regardless of the weight of the child up to 100 lb (45 kg).

Verify the following before using LATCH in the booster mode:

- The lower anchor connectors **DO NOT** interfere with any vehicle seat belts or buckles.

If the lower anchor connectors interferes with the vehicle seat belts or if the chosen seating position does not have lower anchor connectors, you **MUST** store the lower anchor strap. Store lower anchor attachment by placing lower anchor strap and connectors in storage compartment. Store the tether strap as shown. Always secure car seat with lower anchor attachment or a vehicle seat belt, even when unoccupied. In a crash, an unsecured car seat can injure passengers.

Skip to Step 10 if Not Using LATCH

4. Remove Lower Anchor Connectors and Tether from Storage Locations

Unhook tether and lay it in the seat.

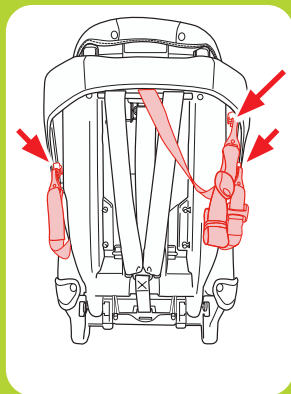
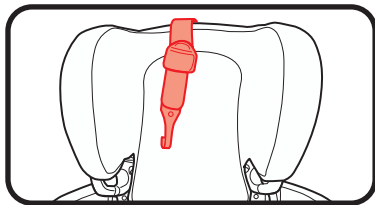

5. Extend the Lower Anchor Strap.

For easier installation, extend the lower anchor strap to its maximum length by pressing the grey button and pulling on the strap.

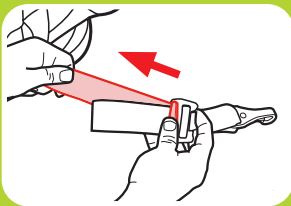

**5-B Highback
Booster**



5-B Highback Booster

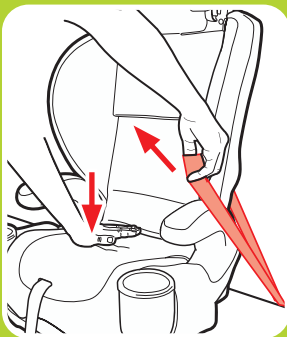
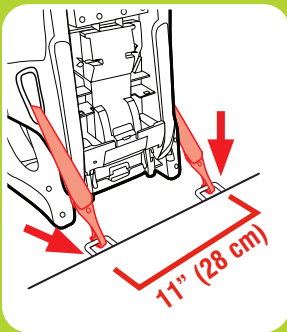

6. Attach Lower Anchor Connectors to Vehicle's Lower Anchors

The lower anchor strap should not be twisted.

Lower anchor connectors can only be used if the vehicle lower anchor spacing is 11 inches (28 cm) from the center of one lower anchor to the center of the other lower anchor.

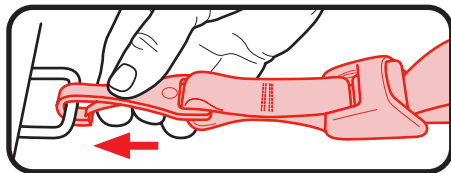

7. Tighten the Lower Anchor Strap

Remove all the slack from the lower anchor strap.

Do not pull on the strap with excessive force.

8. **Attach Tether Strap**

Extend the tether by lifting up on the tether lock and attach.

Consult vehicle owner's manual for specific location.

9. **Tighten Tether Strap**

Remove all the slack.

- 10. Thread the Vehicle Seat Shoulder Belt Through Seat Belt Guide on the Headrest**
See section 5-D to secure your child.

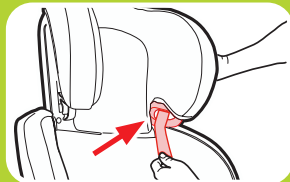
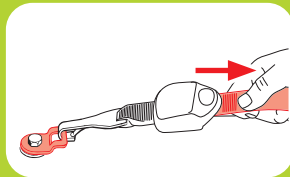
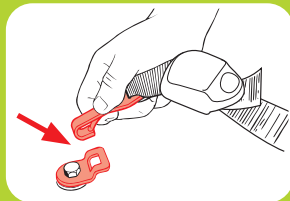
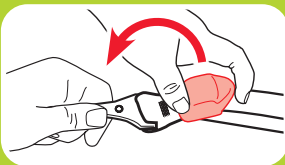

**5-B Highback
Booster**



5-C Install Backless Booster

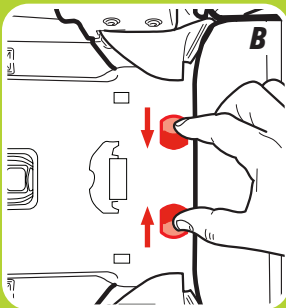
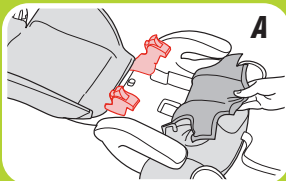

1. Remove the Seat Back

- A.** See section 5-B for instructions on how to lower the seat back into a flat position.



- B.** Squeeze the 2 buttons near the seat crease together and slide lower backrest out of the base.

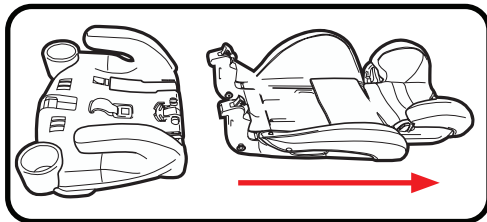

C. Replace the Seat Pads

Reattach the 2 snaps near the seat crease. Reattach the 2 elastic loops and 2 snaps the back of the seat.

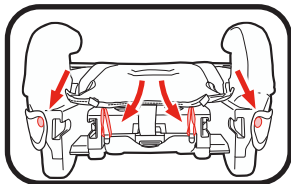

2. Place Booster Seat in the Most Upright Position

Pull the recline handle out and push down on front of seat. Put the booster seat in the most upright position.

3. Place Booster Seat Forward-Facing in Back Seat of the Vehicle

Place forward-facing on a vehicle seat that has a lap/shoulder seat belt. The bottom of the seat should sit as flat as possible on the vehicle seat.

See section 5-E to secure your child.

49

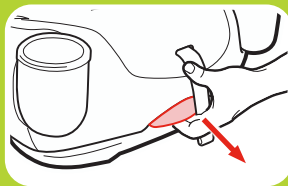
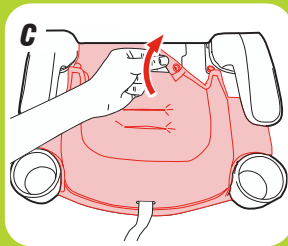

**5-C Backless
Booster**



5-D Securing Child Highback Booster

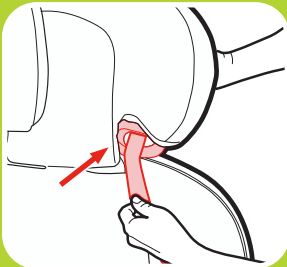

⚠ WARNING!

Warning! Use only the vehicle lap and shoulder belt system when restraining the child in the booster seat.

1. Place Child In Seat

Have your child sit in the booster seat, with his/her back flat against the back of the booster seat.

2. Thread Vehicle's Shoulder Belt Into Seat Belt Guide in the Headrest

3. Buckle the Vehicle Lap/Shoulder Seat Belt

Pull up on the shoulder belt to remove all the slack. Be sure the lap portion of the vehicle seat belt goes in front of the armrests.

Be sure the lap portion of the vehicle seat belt lies low across your child's hips.

Be sure the shoulder belt lies across your child's shoulders, between the neck and edge of shoulder. The belt guides should be even with or just above the shoulders.

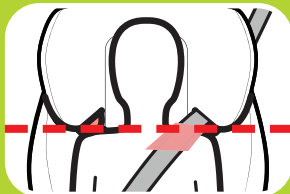
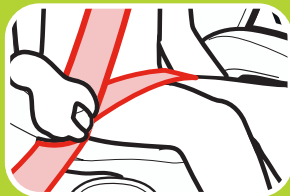

5-D Securing Child
Highback Booster



5-E Securing Child Backless Booster

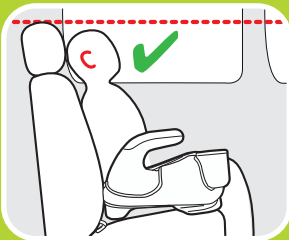

⚠ WARNING!

Warning! Use only the vehicle lap and shoulder belt system when restraining the child in the booster seat.

1. Place Child In Seat

Have your child sit in the booster seat, with his/her back flat against the back of the vehicle seat.

2. Ears Must Be Below the Top of the Vehicle Seat Back or Headrest

3. Buckle the Vehicle Lap/Shoulder Seat Belt

Pull up on the shoulder belt to remove all the slack. Be sure the lap portion of the vehicle seat belt goes in front of the armrests.

Be sure the lap portion of the vehicle seat belt lies low across your child's hips.

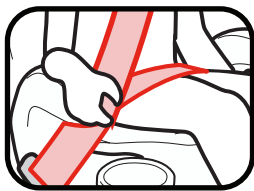

Be sure the shoulder belt lies across your child's shoulders, between the neck and edge of shoulder.

You may need to use the belt positioning clip to help get a good fit.

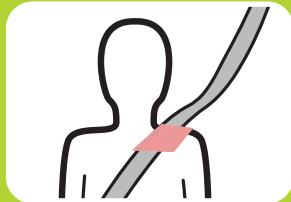

5-E Securing Child
Backless Booster

Using Belt Positioning Clip

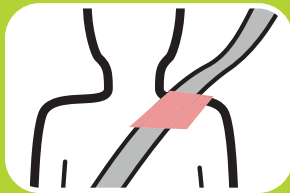

1. **Make Sure Vehicle's Seat Shoulder Belt Lays in the Red Zone As Shown**

If the vehicle's seat shoulder belt lays outside this zone, you **MUST** use the belt positioning clip. Do not use the belt position clip if the belt is already laying inside this zone.

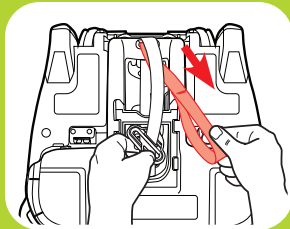

2. **Attach Belt Positioning Clip**

The shoulder belt positioning clip **MUST** be attached to the slot on the bottom of the base. Insert the loop end of strap through the slot on bottom of seat exactly where shown.

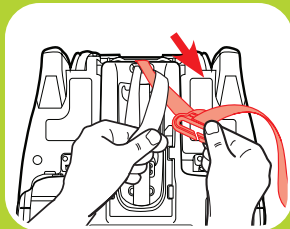

3. **Push Clip and Strap Through Loop**

Pass the clip and the strap through the loop end as shown and pull strap up.

4. Free End of Strap Should Face Front of Seat

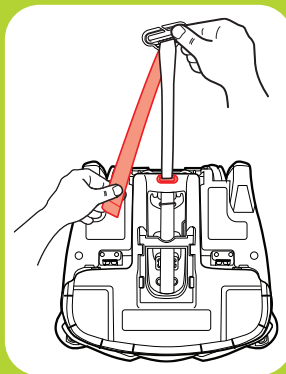

5. Place Child in Seat, Buckle Child In Seat and Attach Belt Positioning Clip

With child's back flat against the back of the vehicle seat, buckle child in. Then slide the clip onto the vehicle's seat shoulder belt as shown.

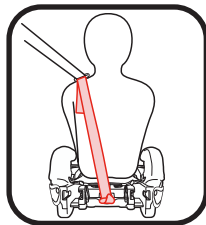

Rear View

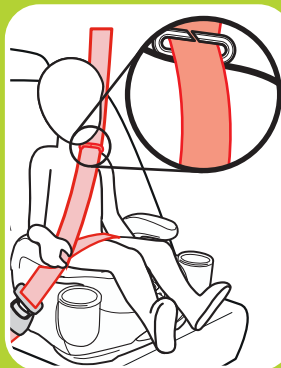

5-E Securing Child
Backless Booster

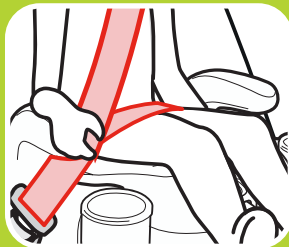
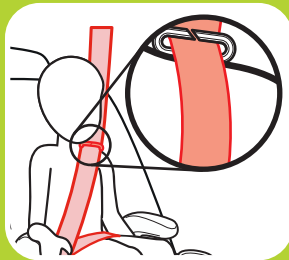
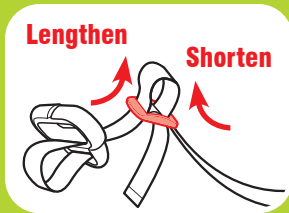

6. Adjust the Belt Positioning Clip to Fit Your Child

Lengthen or shorten the belt length as shown.

Clip should fit right at the top of shoulder as shown.

Pull up on the shoulder belt to remove all the slack. Be sure the lap portion of the vehicle seat belt goes in front of the armrests.

6-A How to Uninstall Lower Anchor Connectors and Tether

Lower Anchor Connectors

Press in on the hook's spring. Push hook in, lift hook up, twist and pull out away from anchor point.

Tether

To remove, lift up on the tether lock to release the tension.

Press in on the hook's spring. Push tether hook in, then lift up and pull away from tether anchor.

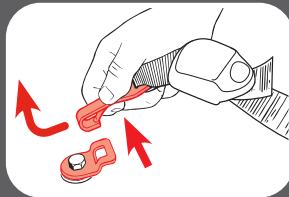
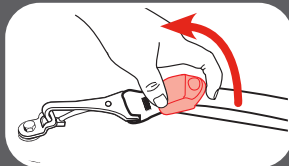
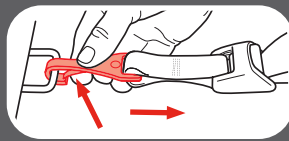

6-B Which Installation Method Should I use?

This car seat can be installed in your vehicle using either the vehicle seat belt **OR** the lower anchor attachment. Both are equally safe to use. **INSTALL USING ONLY ONE METHOD.**

Vehicle Seat Belt: Review section 6-E and your vehicle owner's manual to learn how to install your car seat with the vehicle seat belts.

LATCH or Lower Anchor Attachment: The LATCH system or lower anchor attachment allows you to securely attach your safety seat in your car without using the vehicle seat belt and possibly to get a better fit. All 2003 and newer model year vehicles are required to have a LATCH system, although some manufacturers began including LATCH earlier. Some vehicle owner manuals use the term ISOFIX to identify the LATCH system. **Review your vehicle owner's manual for exact location and use.**

Vehicle's Tether Anchor



Vehicle Seat Belt

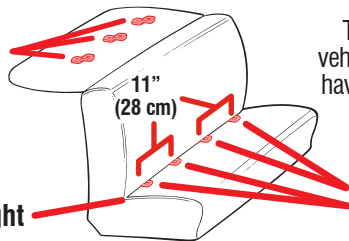

Typical seat in a passenger vehicle. Other vehicle types may have different lower anchor and tether anchor locations.

Vehicle's Lower Anchor



6-C Choosing Vehicle Seat Location

Review your vehicle owner's manual for Seating Locations

The best seating location for this car seat is one that:

- Is recommended by your vehicle owner's manual, and
- Results in a secure installation of this car seat

In the event there is no available back seat and / or you have no other option, the National Highway Traffic Safety Administration (NHTSA) recommends that you take the following steps:

- Ensure the child is properly restrained according to their age and size
- Move the seat as far back as possible
- Make sure the child is not leaning out of position, such as leaning forward into the deployment path of the air bag
- Set the air bag ON-OFF switch, if available, to the OFF position

6-D Unsafe Vehicle Seat Location

Never install this car seat in any of the following vehicle seating locations:



rear-facing or side-facing vehicle seats



booster mode with vehicle lap belt
only seat belt

6-E Vehicle Seat Belts

Review your vehicle owner's manual for vehicle seat belt use

This car seat can be installed using a vehicle seat belt. To do this, you will need to change the seat belt to a locked mode for use with car seats. With some vehicle seat belts, this is done with the latch plate; with other vehicle seat belts, this is done with the retractor.

Vehicle Seat Belt Terms

Retractor

A device that winds up the unused vehicle seat belt. It is often hidden inside the panels on the walls of the vehicle or in the vehicle seatback.

Latch Plate

The male end of the seat belt with the silver tongue.

Seat Bight

The crease where the vehicle seat back and seat bottom meet.

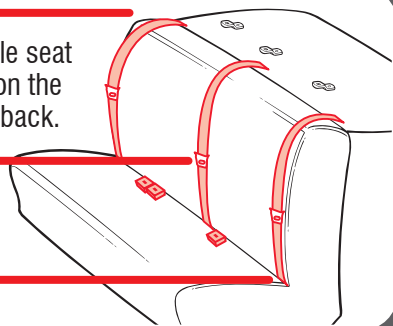

Identify Your Seat Belt Type

There are two different types of vehicle seat belts that can be used with this car seat:

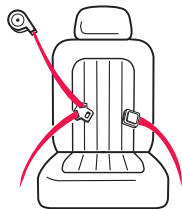

Lap/Shoulder Belt

3 connections points. Can be used in all car seats modes of use.

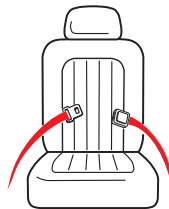

Lap Belt Only

2 connection points. **Can ONLY be used in harness mode.**

The following types of vehicle seat belts **CANNOT** be used safely with this car seat:



Lap Belt with Motorized Shoulder Belt



Lap Belt or Shoulder Belt Mounted on Door

Belts Forward of the Seat Bight

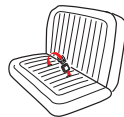

Some vehicles you may not get a secure fit. Read both your vehicle and car seat manuals.

Lap/Shoulder Belt Installation

Always review your vehicle owner's manual for specific information about your vehicle seat belts.

Most vehicles manufactured after 1996 will have Switchable retractors in the backseat. If you have any questions about your retractor type, consult your vehicle owner's manual, call Graco or visit:

<http://www.gracobaby.com/vehicle-seatbelt-information>

To verify you have a Switchable retractor, slowly pull the belt all the way out, and then allow it to retract several inches. Try to pull the belt all the way out again. If it cannot be pulled out, it is Switchable retractor. Follow the steps in the forward-facing sections in this manual.

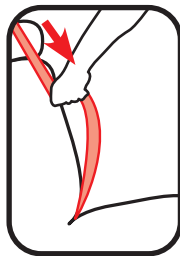



7-A Cleaning Seat Pad

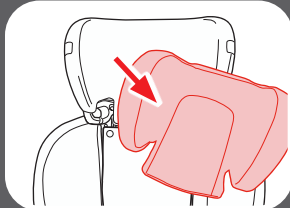
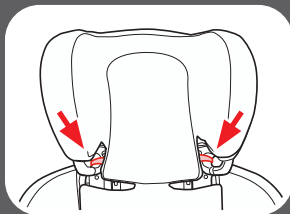
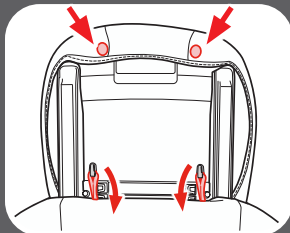

Refer to seat pad care tag for washing instructions.

Headrest Pad

Clean with a damp sponge using mild soap and cool water. If needed, the headrest pad may be removed for cleaning.

To remove, raise the headrest to the highest position.

Undo the two snaps and the two elastic loops from the back of the headrest.

Slide the elastic retaining loops out of the belt guides.

Remove headrest pad.

Machine wash pad in cold water on delicate cycle and drip-dry. **DO NOT USE BLEACH.**

Reverse the steps to reattach the pad on the headrest.

Upper Backrest Pad

Clean with a damp sponge using mild soap and cool water. If needed, upper backrest pad may be removed for cleaning.

To remove upper backrest pad, undo the two snaps then remove.

Machine wash pad in cold water on delicate cycle and drip-dry. **DO NOT USE BLEACH.**

Reverse the steps to replace the upper backrest pad.

Backrest Pad

Clean with a damp sponge using mild soap and cool water. If needed, backrest pad may be removed for cleaning.

To remove backrest pad, undo the two snaps on the front of the backrest.

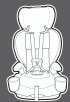
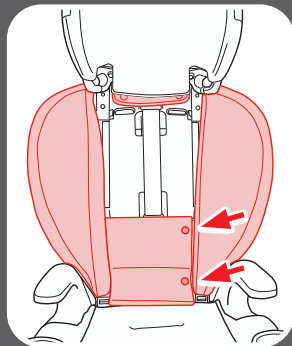
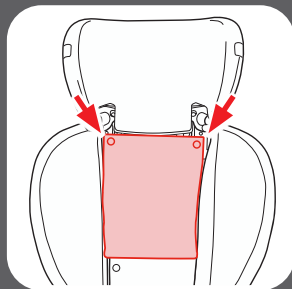



7 Care & Cleaning

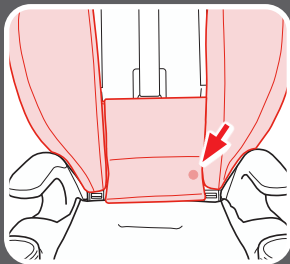

Then undo the lower snap underneath the backrest pad.

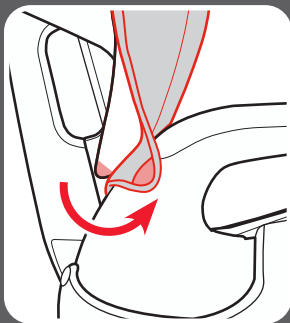

Pull the fabric out from around the corner near the rear of the armrests.

Raise the headrest to the highest position.

Pull out the tab from the top of the seat back.

From the front of the seat just below the headrest, undo the two snaps, pull the pad off of the shell.

Machine wash pad in cold water on delicate cycle and drip-dry. **DO NOT USE BLEACH.**

Reverse the steps to reattach the backrest pad.

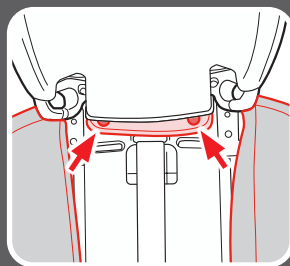
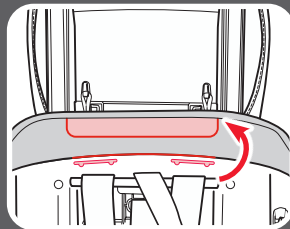
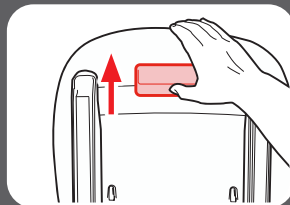

7
Care &
Cleaning

7 Care & Cleaning

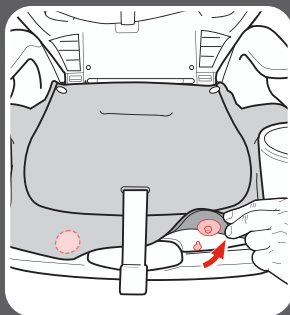
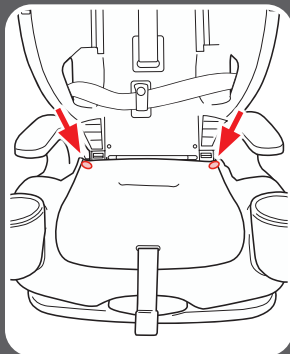

Seat Pad

Clean with a damp sponge using mild soap and cool water. If needed, seat pad may be removed for cleaning.

To remove seat pad, unhook the elastic loops and the two snaps from the back of the seat.

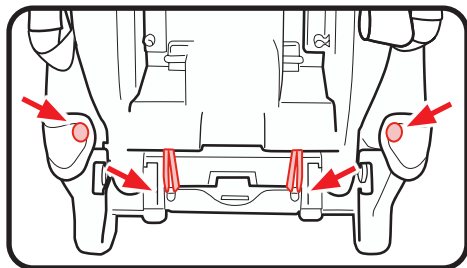

Then undo the two snaps near the seat crease.

Pull down on the two tabs on the front of the seat pad to remove them from the keyholes.

Lift the seat pad to remove.

Machine wash pad in cold water on delicate cycle and drip-dry. **DO NOT USE BLEACH.**

Reverse the steps to reattach the seat pad.

7-B Cleaning Buckle

From bottom of car seat, rotate metal retainer to side in order to push it through slot easier. Pull buckle strap from child restraint as shown.

To clean buckle, place in a cup of warm water and gently agitate the buckle. Press the red button several times while in the water.

DO NOT SUBMERGE THE BUCKLE STRAP. DO NOT USE SOAPS, HOUSEHOLD DETERGENTS or LUBRICANTS.

Shake out excess water and allow to air dry. Repeat steps as needed until it fastens with a click. Re-insert the buckle into the same slot it was removed. Pull up on buckle strap to make sure it is secured.

WARNING! Inspect and clean buckle from time to time to remove any objects or debris that could prevent latching.

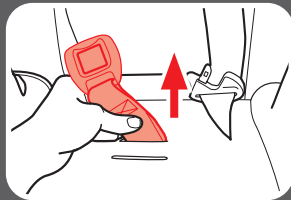
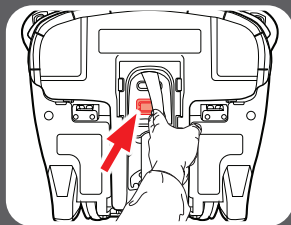

7
Care &
Cleaning

7-C Cleaning Harness, Lower Anchor Attachment and Tether

Surface wash only with mild soap and damp cloth. **DO NOT IMMERSE THE HARNESS STRAPS, LOWER ANCHOR STRAP, or TETHER STRAP IN WATER.** Doing so may weaken the straps.

If harness straps, lower anchor strap or tether strap are frayed or heavily soiled, contact Customer Service at www.gracobaby.com or 1-800-345-4109.



Notes

Replacement Parts

To purchase parts or accessories in the United States,
please contact us at the following:

www.gracobaby.com

or

1-800-345-4109

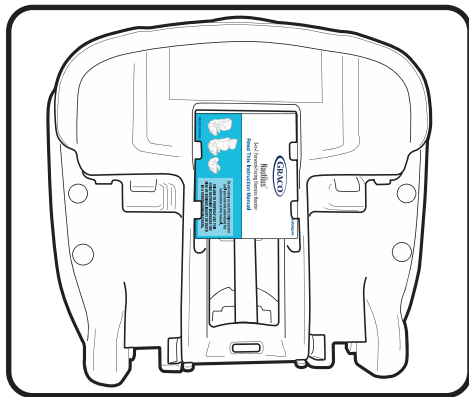

Store instruction
manual in the slot with
the instruction book
icon as shown.