

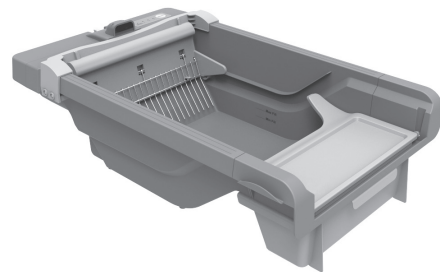

# self-cleaning litter box

CSLB



## INSTRUCTION MANUAL

### IMPORTANT SAFEGUARDS

When using electrical appliances, basic safety precautions should always be followed including the following:

1. Read all instructions before using this product.
2. To protect against electrical shock do not immerse cord, plugs, or litter box in water or other liquid.
3. Do not place or store appliance where it can fall or be pulled into a tub or sink.
4. Unplug from outlet when not in use, when putting on or taking off parts and before cleaning.
5. Close supervision is required when this device is used near children.
6. Do not use appliance for other than intended use.
7. Do not operate any product with a damaged cord or plug or after the appliance malfunctions or has been damaged in any manner. Return product to the nearest authorized service facility for examination, repair, or adjustment.
8. Do not use your Self-Cleaning Litter Box outdoors, in a wet, damp or moist environment, or in direct sunlight.
9. Keep hands away from moving parts.
10. The use of accessory attachments not recommended by the manufacturer may cause injuries.
11. Do not place on or near a hot gas or electric burner.
12. Always attach plug to product first, then plug cord into the wall outlet. To disconnect, turn any control to OFF, then remove plug from wall outlet.

### SAVE THESE INSTRUCTIONS

#### About this product:

The Clump & Seal® Self-Cleaning Litter Box is an effortless and hygienic way to trap and dispose of used cat litter and waste. This unique system automatically rakes waste into a convenient drawstring disposable bag for easy removal, while odor filters and a waste receptacle lid prevent strong litter odors from escaping into your home.

- This product features an Add Litter fill line. Always make sure the amount of litter is to the fill line for optimum results.
- This product requires electrical power from a standard 120V/60 Hz household wall outlet. No other power source should be used.
- This product can be set to automatically complete a Cleaning Cycle hourly, every 4 hours, or every 8 hours. You can also perform an immediate Cleaning Cycle by pressing and holding the SELECT button until the "Hourly" LED lights up. Please see Figure 10 for more details.
- This product features a Sensor that will detect when your cat enters the box. If your cat enters within 10 minutes before the next timed Cycle, this Cycle will be skipped. **SCENARIO 1:** If the cat enters the box after the forward Cycle is complete, the Sensor will hold up its returning motion until cat exits the litter box. **SCENARIO 2:** If the rake encounters the cat during the returning Cycle, the motor will stop the rake once situation is encountered. A blinking light on the Control Panel will show this error occurred.
- The Litter Tray, Rake Assembly, Waste Receptacle Lid, and Waste Receptacle should be washed periodically with warm, soapy water. This can be done by unlocking and unhinging the detachable motor from the Tray so no electrical parts are washed. The Detachable Motor box can be wiped clean with a damp sponge or pet-friendly cleaning product, but should not be submerged in water. ALWAYS UNPLUG UNIT BEFORE PERFORMING ANY TYPE OF CLEANING.
- Always monitor your cat's usage during the first 72 hours to make sure the intervals are not spaced apart too widely.
- This device should only be used by cats.
- This product is not to be used by cats less than 6 months old.
- Your cat should be in good health when using this product.
- Pregnant women should avoid exposure to litter.

### DO NOT USE THIS AUTOMATIC LITTER BOX UNTIL YOU HAVE READ THESE INSTRUCTIONS

#### Product Overview:

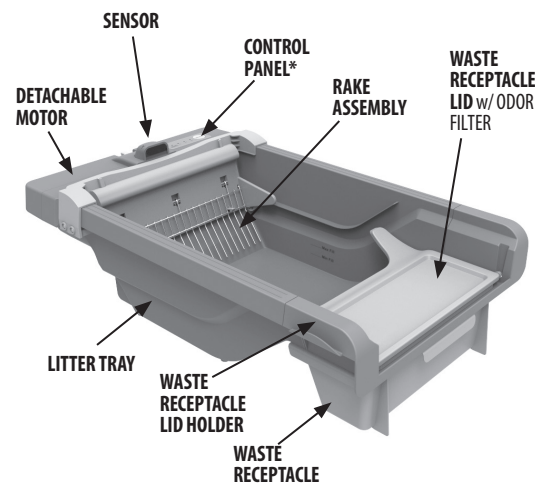

#### \*Control Panel:

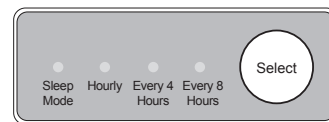

Pressing the SELECT button repeatedly will cycle through cleaning cycle options: hourly, every 4 hours, every 8 hours or Sleep Mode (no cycle).

#### Product Setup:

1. The Rake Assembly will come pre-installed in the Litter Box. Check to make sure that the Rake Assembly can move up and down freely, and leave the Rake in its lowest position before continuing (see Fig. 1).
2. Install Waste Receptacle Lid Holder by pressing both sides down into the litter box tray (see Fig. 2).
3. Then push each post of the Waste Receptacle Lid into the hole at the bottom of the slot on the Waste Receptacle Lid Holder. When installed correctly, both sides of the lid should be level and feel very secure in place. Ensure both sides are firmly connected before continuing (see Fig. 3).

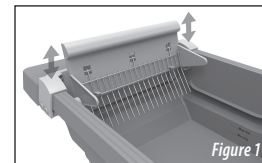

Rake assembly

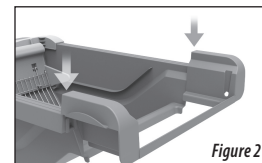

Waste Receptacle assembly

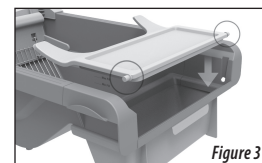

Waste Receptacle Lid assembly

4. Place the assembled Litter Box where your cat will be using it. Make sure the Litter Box is located near an electrical outlet, and that the cord will not block any walkways and is away from any sources of moisture.



Figure 4

5. Place the Drawstring Bag into the Waste Receptacle, folding the sides over the edges as shown in Figure 4.

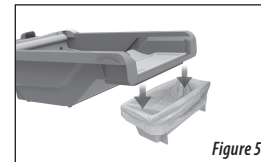

Figure 5

6. Slide the Waste Receptacle (with bag) into place as shown in Figure 5. Line the Receptacle up under the opening so that no waste will miss the Receptacle (see Fig. 6).

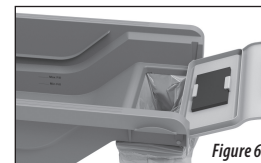

Figure 6

7. Locate the Detachable Motor and align the tabs with their corresponding slots on the back of the Litter Tray, as shown in Figure 7.

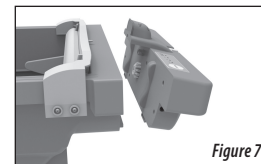

Figure 7

**NOTE:** The Odor Filter is pre-installed and typically only needs to be changed monthly. Be sure to remove the plastic protective bag around the Odor Filter before using it. You may need to change the Filter more frequently depending on your cat's usage and the number of cats in your household. To order more Filters, please visit [www.amazon.com](http://www.amazon.com) or call 1-888-397-2877 and provide your model number.

### Product Setup (cont.):

8. After attaching, and while holding the Detachable Motor to the back of the Litter Tray, turn the blue Locking Knob CLOCKWISE to lock the Motor into place (see Fig. 8).



Figure 8

### Operating Instructions:

1. Add litter to the FILL line in the Litter Tray (see Fig. 9). Your Self-Cleaning Litter Box works with most litter brands, but clumping-type litter works best with this system.

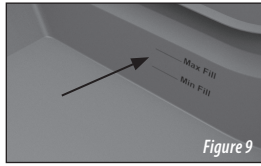

Figure 9

2. Locate the Power Adapter and plug it in to the outlet on the side of the Detachable Motor. The outlet is located underneath the Motor on the left side when facing the Rake Assembly, as shown in Figure 10.

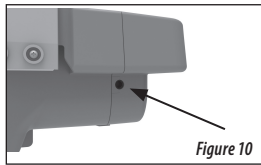

Figure 10

3. Plug the Power Adapter into a standard household wall outlet. The Control Panel LED lights will blink in sequence while the unit is powering up and the first Cleaning Cycle will begin automatically.

**NOTE:** If the Litter Box does not complete one Cleaning Cycle, or if you hear the motor running but the Rake does not move, please go back and review all previous steps.

4. Choose the Cleaning Frequency on the Control Panel by pressing the SELECT Button. The Litter Box will automatically perform one Cleaning Cycle at the time chosen. For example, if you select "Every 4 Hours", the Litter Box will complete a Cleaning Cycle once every 4 hours, as shown in Figure 11.



Figure 11

### For Optimal use:

- Check the Litter Box often during the first 72 hours to ensure normal functionality, that the Cleaning Cycles are being performed at the proper times, and that your cat is adapting to the new box.
- Always keep litter filled to the Litter Fill Line inside the Litter Tray.
- Replace the Waste Receptacle Bag when full. *Make sure to check the Waste Receptacle daily and replace Bag often for optimum results.*
- To prevent odors, replace the Odor Filter every 30 days.
- Clean Rake and Tray by following the Cleaning and Care Instructions.

### Acclimating Your Cat:

- Fill your new Self Cleaning Litter Box with litter as directed and place it near your cat's old litter box, as close to it as possible. Plug in the new Litter Box and set the Cleaning Cycle to run at your desired interval, so your cat can get used to the movement and sounds created by the cycles. This will allow your cat to get used to the new unit, while maintaining the level of comfort they may have with their old litter box.
- After a few days of this, switch the positions of the old and new litter boxes. At this point, DO NOT clean the old litter box anymore; the vast majority of cats prefer a clean, fresh litter box and will refuse to use one that is dirty.

This will encourage them to try the new box if they haven't done so already.

- Once you have noticed your cat is comfortable using the new Self Cleaning Litter Box, you can remove the old litter box.

**NOTE:** If you know that your cat is shy, do not proceed with the automatic cleaning cycle immediately; this will allow him or her to get used to the new unit without being "surprised" by the sounds and movements of the automatic Cleaning Cycles.

### Important Features

- This product features a Sensor that will detect when your cat enters the box. If your cat enters within 10 minutes before the next timed Cycle, this Cycle will be skipped. **SCENARIO 1:** If the cat enters the box after the forward Cycle is complete, the Sensor will hold up its returning motion until cat exits the litter box. **SCENARIO 2:** If the rake encounters the cat during the returning Cycle, the motor will stop the rake once situation is encountered. A blinking light on the Control Panel will show this error occurred.
- The LED lights on the Control Panel will flash in the event of a power failure. If this occurs, you must manually reset the unit by pressing and holding the SELECT Button for 3 seconds; the LED lights will flash in sequence and a single Cleaning Cycle will be performed. If you reset the unit, you must also reselect a Cleaning Cycle interval; the motor does not have an internal memory and will default to hourly cleanings unless programmed otherwise.
- You can also reset the unit by unplugging the Power Adapter from the wall outlet and plugging it back in.
- The LED lights will flash if an abnormally large clump of litter waste is detected in order to protect the motor; if this occurs, you must manually remove the clump and perform a manual reset as described above.

### Care & Cleaning:

**Caution: Always unplug unit before doing any type of cleaning.**

Although this product requires very little maintenance, some occasional cleaning and removal of waste product is a necessary part of usage:

- Check the Litter Box often during the first 72 hours to ensure normal functionality, that the Cleaning Cycles are being performed at the proper times, and that your cat is adapting to the new box.
- Replace the Waste Receptacle Bag when full.
- When replacing Drawstring Receptacle Bag, the Waste Receptacle should be washed with warm, soapy water and allowed to dry completely before reinstalling. Always replace with Arm & Hammer® Clump & Seal® branded waste receptacle liners.

**Caution: To protect against electrical shock do not immerse cord, plugs, or litter box in water or other liquid.**

- The Litter Tray, Rake Assembly and Waste Receptacle Lid should be washed periodically with warm, soapy water. The Detachable Motor can be wiped clean with a damp sponge or pet-friendly cleaning product, but should not be submerged in water. ALWAYS UNPLUG UNIT BEFORE PERFORMING ANY TYPE OF CLEANING.

- Make sure any washed parts are allowed to dry completely before reassembling unit.

### Troubleshooting:

There are three reasons why the LED lights on the Control Panel may begin flashing, indicating that there is a problem with the Cleaning Cycle:

	Problem	Possible Solutions
Raking	Rake will not move	Clear obstruction
Obstruction	Waste clumps too large to be raked	This is a safety feature that protects the motor from burnout. If large clumps are the cause of the flashing LED lights, you must manually remove the clump and perform a manual reset as described above.
Odor Control	The waste bin is emitting more odors than normal	Replace filter

	Problem	Possible Solutions
Power Failure	Unit loses power during cleaning cycle	Manually reset the unit by pressing and holding the SELECT button for 3 seconds, or you can reset the unit by unplugging the Power Adapter from the wall outlet and plugging it back in; the LED lights will flash in sequence and a single Cleaning Cycle will be performed. <i>If you reset the unit, you must also reselect a Cleaning Cycle interval; the motor does not have an internal memory and will default to hourly cleanings unless programmed otherwise.</i>

**NOTE:** If the Litter Box does not complete one Cleaning Cycle, or if you hear the motor running but the Rake does not move, please go back and review all previous steps.

### Replacement Parts:

Replacement parts are available by calling the Customer Service at 1-888-397-2877 during the hours of 8am EST – 5pm EST, Monday through Friday (major holidays excluded). Parts available for replacement are:

**Odor Filters & Liners:** CSLB-FIL-BAG15

To order additional Odor Filters or Disposable Drawstring Receptacle Bags, visit [www.amazon.com](http://www.amazon.com) or call 1-888-397-2877 and provide your model number, located inside the detachable motor.

### Limited 1-Year Warranty

#### In the United States and Canada:

If you have any question regarding this warranty or would like to obtain warranty service, please call 1-866-537-2249 and a convenient service center address will be provided to you. Sunbeam Products, Inc. doing business as Jarden Consumer Solutions, or if in Canada, Sunbeam Corporation (Canada) Limited doing business as Jarden Consumer Solutions (collectively "JCS") warrants that for a period of one year from the date of purchase, this product will be free from defects in material and workmanship. JCS, at its option, will repair or replace this product or any component of the product found to be defective during the warranty period. Replacement will be made with a new or remanufactured product or component. If the product is no longer available, replacement may be made with a similar product of equal or greater value. This is your exclusive warranty.

DO NOT attempt to repair or adjust any electrical or mechanical functions on this product. Doing so will void this warranty.

This warranty is valid for the original retail purchaser from the date of initial retail purchase and is not transferable. Keep the original sales receipt. Proof of purchase is required to obtain warranty performance. JCS dealers, service centers or retail stores selling JCS products do not have the right to alter, modify or any way change the terms and conditions of this warranty. This warranty does not cover normal wear of parts or damage resulting from any of the following: negligent use or misuse of the product, use on improper voltage or current, use contrary to the operating instructions, disassembly, repair or alteration by anyone other than JCS or an authorized Sunbeam® service center. Further, the warranty does not cover: Acts of God, such as fire, flood, hurricanes and tornadoes.

#### What are the limits on Sunbeam's liability?

JCS shall not be liable for any incidental or consequential damages caused by the breach of any express, implied or statutory warranty or condition. Except to the extent prohibited by applicable law, any implied warranty or condition of merchantability or fitness for a particular purpose is limited in duration to the duration of the above warranty. JCS disclaims all other warranties, conditions or representations, express, implied, statutory or otherwise. JCS shall not be liable for any damages of any kind resulting from the purchase, use or misuse of, or inability to use the product including incidental, special, consequential or similar damages or loss of profits, or for any breach of contract, fundamental or otherwise, or for any claim brought against purchaser by any other party.

Some provinces, states or jurisdictions do not allow the exclusion or limitation of incidental or consequential damages or limitations on how long an implied warranty lasts, so the above limitations or exclusion may not apply to you. This warranty gives you specific legal rights, and you may also have other rights that vary from province to province, state to state or jurisdiction to jurisdiction.

In the U.S.A., this warranty is offered by Sunbeam Products, Inc. doing business as Jarden Consumer Solutions located in Boca Raton, Florida 33431.

In Canada, this warranty is offered by Sunbeam Corporation (Canada) Limited, doing business as Jarden Consumer Solutions located at 20 B Hereford Street, Brampton, Ontario L6Y 0M1.

### PLEASE DO NOT RETURN THIS PRODUCT TO ANY OF THESE ADDRESSES OR TO THE PLACE OF PURCHASE.

The ARM & HAMMER™ name logo and associated marks are trademarks of Church & Dwight Co., Inc. These marks are used under license by Sunbeam Products, Inc. doing business as Jarden Consumer Solutions.

Patent Pending  
© 2015 Sunbeam Products, Inc. doing business as Jarden Consumer Solutions. All rights reserved. Distributed by Sunbeam Products, Inc. doing business as Jarden Consumer Solutions, Boca Raton, Florida 33431.

Printed in China  
GCDS-ARM41967-SL

CSLB\_15EM1

PN 185157