

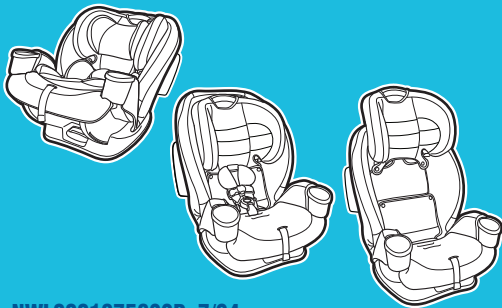

TrioGrow™ SnugLock®

3-IN-1 CAR SEAT

Read This Instruction Manual



Do not install or use this child restraint until you read and understand the instructions in this manual.

FAILURE TO PROPERLY USE THIS CHILD RESTRAINT INCREASES THE RISK OF SERIOUS INJURY OR DEATH IN A SUDDEN STOP OR CRASH.

1 Important

Pages 6-27

1-A A Quick Guide to Your Manual

1-B Welcome to the Graco Family

1-C Right Mode of Use

1-D Before You Begin

Register This Car Seat

If You Need Help

Certification

Car Seat's Useful Life

Vehicle Seat Protection

Warm Weather Use

1-E Safety Warnings

2 Features

Pages 28-35

2-A Car Seat Features

3 Rear-Facing Use

Pages 36-60

- 3-A Rear-Facing**
- 3-B Installing Rear-Facing With Lower Anchor Attachment**
- 3-C Install Rear-Facing With Vehicle Seat Belt**

4 Forward-Facing Use

Pages 61-84

- 4-A Forward-Facing**
- 4-B Installing Forward-Facing With LATCH**
- 4-C Install Forward-Facing With Vehicle Seat Belt**

5 Booster

Pages 85-101

5-A Booster Use

5-B Install Highback Booster

6 Securing Child

Pages 102-112

6-A Securing Child 5-Point Harness

6-B Securing Child Highback Booster

7 Accessories

Pages 113-114

8 Moving Lower Anchor Attachment *Pages 115-119*

9 Additional Information

Pages 120-134

- 9-A How to Uninstall LATCH**
- 9-B Choosing Vehicle Seat Location**
- 9-C Unsafe Vehicle Seat Locations**
- 9-D Vehicle Seat Belts**
- 9-E Aircraft Installation**

10 Care & Cleaning

Pages 135-142

- 10-A Cleaning Seat Pad**
- 10-B Cleaning Crotch Buckle**
- 10-C Cleaning Harness, Lower Anchor and Tether**

1-A A Quick Guide to Your Manual

This car seat is for children: *Rear-Facing: 5-40 lb (2.2-18 kg)*

Forward Facing: 26.5-65 lb (12-30 kg)

Booster: 40-100 lb (18.1-45 kg)

- Children less than 26.5 lb (12 kg) **MUST** use this car seat rear-facing. Review section 1-C for more information.

Note: Preterm or low birth weight infants may be at special risk in a vehicle or aircraft. According to the AAP, these infants may suffer breathing issues if improperly reclined in a car seat. When rear-facing, use the corrected age for preemies. Graco advises that you have your physician or hospital staff evaluate your infant and recommend the proper car seat or car bed before you and your infant leave the hospital.

Install Cup Holders

Adult Assembly Required

The cup holders **must** be installed.

To attach the cup holders, match the right cup holder to the right side of the seat and the left to the left. Slide the hook on the cup holder into the slot in the seat, then rotate the bottom of the cup holder down until you hear a “Click”. **You will hear a “Click” when they are secured in place.**

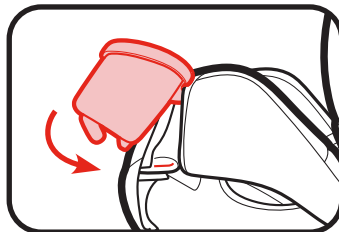
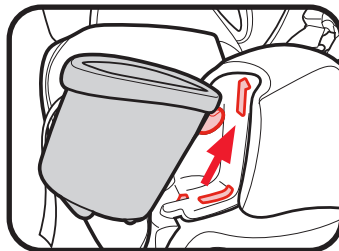
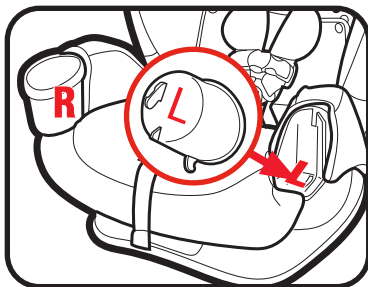

i 1 Important



1 Important

Get to Know Your Car Seat

Review section 2-A to see all of the features of this car seat.

What Seating Location Should I Use?

The best seating location for this car seat is one that:

- Is recommended by your vehicle owner's manual, and
- Results in a secure installation of this car seat.

Some vehicles have specific requirements for where the car seat can be installed, so be sure to check your vehicle owner's manual for available seating positions, if any.

Review section 9-B, 9-C of this manual AND your vehicle owner's manual.

According to accident statistics, the safest place for your child in any vehicle is the back seat. The center of the back seat can be the safest during a possible side impact.



i 1 Important

Which Installation Method Should I Use?

This car seat can be installed in your vehicle using either the vehicle seat belt **OR** the LATCH system **OR** the lower anchor system. All are equally safe to use. **INSTALL USING ONLY ONE METHOD.**

Vehicle Seat Belt: Review section 9 and your vehicle owner's manual to learn how to install your car seat with the vehicle seat belts.

LATCH or Lower Anchor Attachment: The LATCH system or Lower Anchor Attachment allows you to securely attach your safety seat in your car without using the vehicle seat belt and possibly to get a better fit. All 2003 and newer model year vehicles are required to have a LATCH system, although some manufacturers began including LATCH earlier. Some vehicle owner manuals use the term ISOFIX to identify the LATCH system.

What is LATCH?

LATCH consists of lower anchors and a tether anchor, which are built-in to your vehicle, and lower anchor attachments and tether that is built-in to your car seat. Lower anchor attachments are used **INSTEAD** of the vehicle's seat belt to secure the child seat to the vehicle. The tether is used **IN ADDITION** to the lower anchor attachments **OR** the vehicle's seat belt to secure a forward-facing car seat to the vehicle.

Review your vehicle's owner manual for exact location and use.

Vehicle Tether Anchor

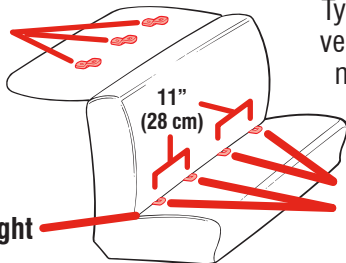

Vehicle Seat Belt

Typical seat in a passenger vehicle. Other vehicle types may have different lower anchor and tether locations.

Vehicle Lower Anchor



When Installing This Car Seat

Lower Anchor Attachment

The Lower Anchor Attachment consists of two lower anchors, which are built-in to your vehicle, and lower anchor connectors that are built-in your car seat. Review section 3-B, 4-B & 5-B of this manual AND your vehicle owner's manual.

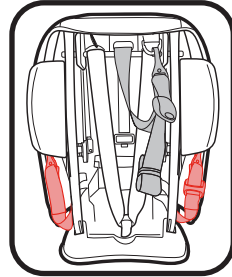
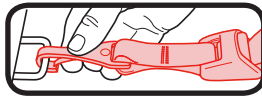

i 1 Important

Vehicle Seat Belt

There are two types of vehicle seat belts that can be used When Installing Rear-Facing & Forward-Facing. Lap/Shoulder Seat Belt or Lap Only Seat Belt.

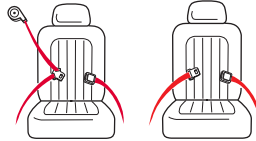

Only use the Lap/Shoulder seat belt configuration when Installing As a Booster. Review section 3-C, 4-C & 5-B of this manual AND your vehicle owner's manual.

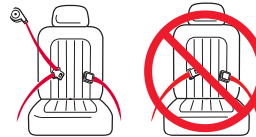

Does Your Car Seat Fit Your Child Correctly?

To make sure your child is secured properly, review section 3, 4 & 5 to understand all of the actions you need to take to properly adjust the car seat to fit your child.

For Rear-Facing, You Need to Adjust:

Harness Height, Rear-Facing

(A) Harness straps at or just below the child's shoulders **(B)** and top of head **must** be at least 1" (2.5 cm) below the headrest adjustment lever. Review section 6.

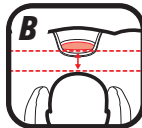

Buckle Position (C)

The correct slot is the one that is closest to your child without being underneath them. Review section 6.

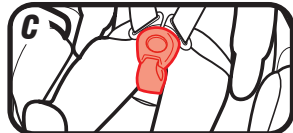

Harness Tightness (D)

If your fingers slide off the harness straps without pinching the straps, it is tight enough. Review section 6.

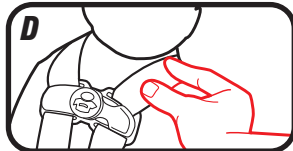

For Forward-Facing, You Need to Adjust:

Harness Height, Forward-Facing

(A) Harness straps at or just above the child's shoulders **(B)** and top of child's ears below top of headrest. Review section 6.

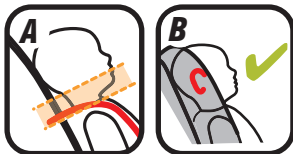

Buckle Position (C)

The correct slot is the one that is closest to your child without being underneath them. Review section 6.

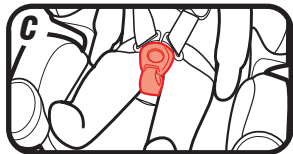

Harness Tightness (D)

If your fingers slide off the harness straps without pinching the straps, it is tight enough. Review section 6.

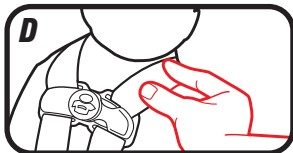

For Booster, You Need to Adjust:

Use Lap/Shoulder Belt Only

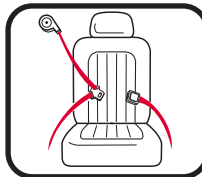

Position Lap Belt

Lap belt must go behind armrest and lie low across your child's hips and thighs.

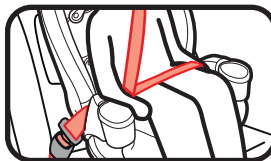

Position Shoulder Belt

Shoulder belt lies across shoulder between neck and edge of shoulder.

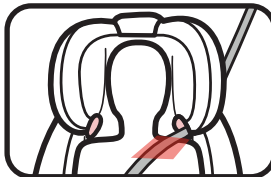

Rear-Facing Installation

Car Seat Does Not Move More than 1" (2.5 cm) at the Belt Path (A)

Review section 3

Check level Line (B)

Review section 3

Harness Straps at or Just Below Child's Shoulders (C)

Review section 6

Chest Clip Even With Armpits (D)

Review section 6

Cannot Pinch Harness Straps at the Shoulder (E)

Review section 6

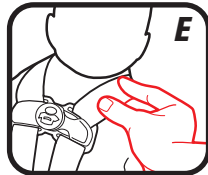
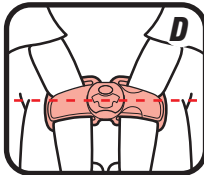
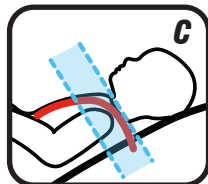
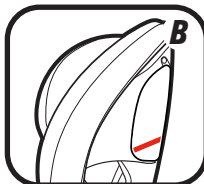
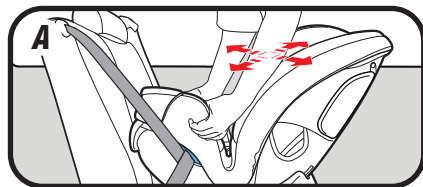

i 1 Important

Forward-Facing Installation

Use the tether when using forward-facing (A)

When used properly, the tether helps reduce injury in a sudden stop or crash.

Review section 4

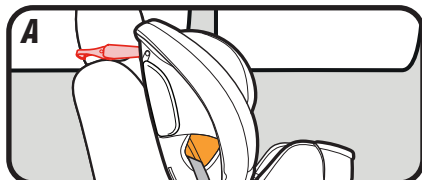

Car Seat Does Not Move More than 1" (2.5 cm) at the Belt Path (B)

Review section 4

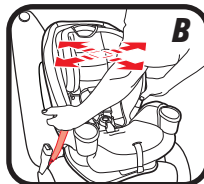

Harness Straps at or Just Above Child's Shoulders (C)

Review section 6

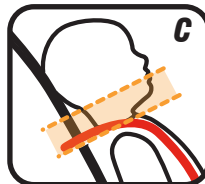

Chest Clip Even With Armpits (D)

Review section 6

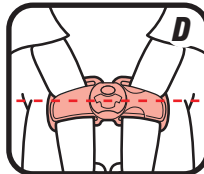

Cannot Pinch Harness Straps at the Shoulder (E)

Review section 6

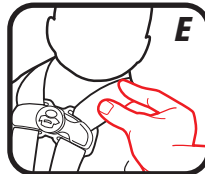

Booster Installation

Never Use Lap Belt Only

Review section 5



Lap Belt Behind Armrest and Lies Low Across Hips and Thighs

Review section 5

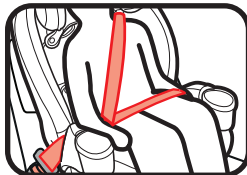

Shoulder Belt Lies On the Shoulder, Between the Neck and Edge of Shoulder

Review section 5



1-B Welcome to the Graco Family!



1 Important

Your child's safety depends on you. No car seat can guarantee protection from injury in every situation, but proper use helps reduce the risk of serious injury or death.

Even if this car seat seems easy to figure out on your own, you must follow the detailed instructions in this instruction manual to ensure all steps are preformed correctly.

Visit: www.gracobaby.com/en-US/safety for more information about Graco's car seat safety standards.

1-C Right Mode of Use

| | | | | |
|------------------|--------------------|--------------------|------------------|-------------------|
| 5 lb (2.2 kg) | 26.5 lb (12 kg) | 40 lb (18.1 kg) | 65 lb (30 kg) | 100 lb (45 kg) |
|------------------|--------------------|--------------------|------------------|-------------------|

Rear-Facing with 5-Point Harness
Must be 49" (125 cm) or less: 5-26.5 lb (2.2-12 kg) less than 1 year old **MUST** be rear-facing. 26.5-40 lb (12-18 kg) **SHOULD** be rear-facing.*

Forward-Facing with 5-Point Harness
Must be 49" (125 cm) or less: 26.5-40 lb (12-18 kg) can sit upright unassisted **CAN** be forward-facing. 40-65 lb (18-30 kg) **SHOULD** be forward-facing.*

Booster Mode with Vehicle Lap/Shoulder Seat Belt **Must be 43-57" (110.1-145 cm) tall and 4+ years old.** 40-65 lb (18.1-30 kg) **CAN** be in booster mode. Over 65 lb (30 kg) **MUST** be in booster mode.*



* Check your local and state laws and the AAP/NHTSA recommendations. See pages 24-25.



1 Important

1-D Before You Begin

Register This Child Restraint

Please fill out the prepaid registration postcard attached to the harness and mail it in today **or register online at www.gracobaby.com/carseatregistration.**

Child restraints could be recalled for safety reasons. You must register this restraint to be reached in a recall. Send your name, address, and the restraint's model number and manufacturing date to:

Graco Children's Products, Inc.

Attn: Customer Service

P.O. Box 169, Elverson, PA 19520-9901

or call 1-800-345-4109

or register online at

www.gracobaby.com/carseatregistration

For recall information, call the U.S. Government's Vehicle Safety Hotline at 1-888-327-4236 (TTY: 1-800-424-9153), or go to <http://www.NHTSA.gov>.

For future reference or if you change addresses, record the model name, model number, date of manufacture and purchase date of this car seat on the below. You can find this information either on the registration card if you still have it or on the date label located on the back of the car seat.

Model Name _____

Model Number _____

Date of Manufacture _____

Date of Purchase _____

If You Need Help

In the U.S.A, please contact our Customer Service Department with any questions you may have concerning parts, use, or maintenance. When you contact us, please have your product's model number and date of manufacture ready so that we may help you efficiently. These numbers can be found on a sticker on the back side of your car seat.

For additional resources or to get your car seat checked by a child passenger safety technician, please visit the following web sites:

www.nhtsa.gov • www.seatcheck.org • www.safekids.org



1 Important

Certification

This child restraint meets or exceeds all applicable requirements of Federal Motor Vehicle Safety Standard 213 for use in motor vehicles.



This child restraint is certified for use in aircraft when using the harness system. Use only on forward-facing aircraft seats. Follow the instructions for vehicle installation and section 9-E for routing the aircraft lap belt over the lockoff. For rear-facing installation, see section 3-C and for forward-facing installation, see section 4-C. See section 9-D “Vehicle Seat Belts” and section 9-E “Aircraft Installation”. Contact the airline for their specific policies.



This child restraint is not certified for aircraft use when used as a booster seat because aircrafts do not have shoulder belts.

Car Seat's Useful Life

STOP using this car seat and throw it away 10 years after the date of manufacture. Look for this sticker on back of the car seat.

Graco Children's Products Inc. advises against loaning or passing along a car seat unless you know the complete history of the product. We also advise against purchasing a car seat second hand.

Vehicle Seat Protection

Protect vehicle seat. Use a car seat mat, towel, or thin blanket under and behind car seat.

Warm Weather Use

Car seat parts can get very hot in the sun or warm weather. **To avoid burns, always check before putting child in car seat.**



1 Important

1-E Safety Warnings

No car seat can guarantee protection from injury in every situation, but proper use helps reduce the risk of serious injury or death. READ THIS MANUAL CAREFULLY.

⚠ WARNING!

Failure to follow these instructions and child restraint's labels can result in child striking the vehicle's interior during a sudden stop or crash.



! NEVER PLACE THIS CHILD RESTRAINT REAR-FACING IN A VEHICLE SEATING LOCATION THAT HAS AN ACTIVE FRONT AIR BAG.

If an air bag inflates, it can hit the child and car seat with great force and cause serious injury or death to your child.

! Review your vehicle owner's manual for more information about air bags and car seat use.

! If your vehicle does not have a back seat, review your vehicle owner's manual.

! Graco recommends making sure the base is a minimum of 80% on vehicle seat when using the 5-point harness.

! Children are safer riding rear-facing and should ride rear-facing as long as possible, until they reach the maximum rear-facing height or weight rating for their car seat. Then children should ride forward-facing, using the built-in harness

system for as long as possible until they reach the maximum forward-facing weight or height for their car seat. At that point, children should ride in a belt-positioning booster seat. A booster is no longer needed once the vehicle seat belt fits properly, typically when they reach 4 feet 9 inches (145 cm) tall and are between ages 8-12. Be sure to check your local and state laws, as well as AAP and NHTSA recommendations, for car seat usage.*

! Choose the correct mode of use for the car seat depending on your child's size. Infants less than 26.5 lb. (12 kg) MUST use this car seat rear-facing.

! Select a suitable location for the car seat in your vehicle.

! Secure car seat with a vehicle seat belt or the lower anchor attachment that is properly routed as shown in this manual.

*Graco Supports the American Academy of Pediatrics and National Highway Traffic Safety Administration's Car Seat Guidelines. Visit www.gracobaby.com/en-US/safety for information on car seat usage recommendations.



1 Important



1 Important

! Vehicle seat belt system MUST hold car seat securely. Not all vehicle seat belts can be used with a car seat.

! If vehicle seat belt does not hold car seat securely, read “Vehicle Seat Belts” section 9-D and your vehicle owner’s manual.

! Always secure car seat with the lower anchor attachment or a vehicle seat belt, even when unoccupied. In a crash, an unsecured car seat can injure passengers.

! If car seat is in a crash, it must be replaced. DO NOT use it again! A crash can cause unseen damage and using it again could result in serious injury or death.

! DO NOT use car seat if it is damaged or missing parts.

! DO NOT use accessories or parts other than those provided by Graco except for a thin towel or mat to protect your vehicle seat or rolled towels or pool noodles to help get your car seat level. Their use could alter the performance of the car seat.

! DO NOT remove LATCH system from car seat. If using vehicle seat belt to secure car seat, lower anchor hooks must be stored.

! Never leave child unattended, even when sleeping. Child may become tangled in harness straps and suffocate or strangle.

! Rear-facing car seat must be properly leveled:

- Too reclined can result in injury or ejection.
- Too upright can result in breathing difficulties.



! Never attach two lower anchor connectors to one vehicle lower anchor unless specifically allowed by the vehicle manufacturer.

! Do not use both the vehicle belt and lower anchor attachment at the same time when using the car seat rear or forward facing.

2-A Car Seat Features



2 Features

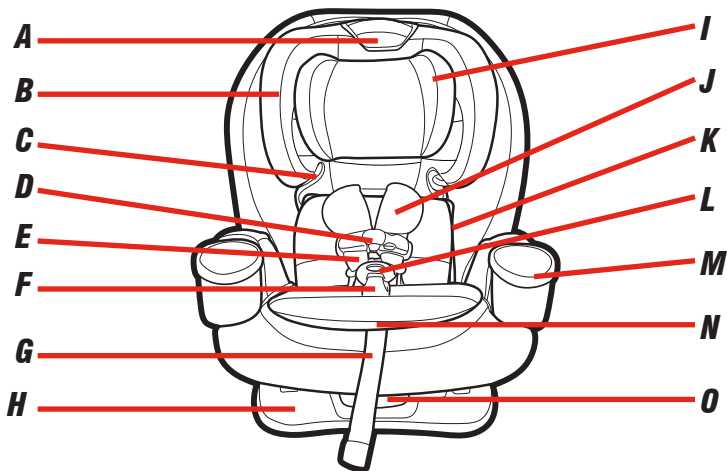

- A Headrest/Harness Adjustment Lever**
- B Headrest**
- C Booster Shoulder Belt Guide**
- D Chest Clip**
- E Harness Straps**
- F Buckle Strap**
- G Harness Adjustment Strap**
- H Seat Base**
- I Head Support**
- J Harness Cover**
- K Body Support**
- L Buckle**
- M Cup Holder**
- N Harness Release Lever**
(under seat pad)
- O Recline Handle**

2 Features

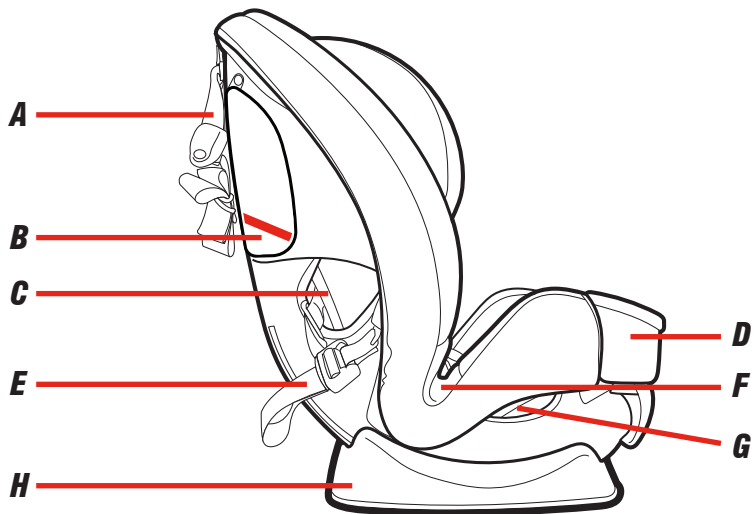

- A Tether***
- B Level Line***
- C Forward-Facing Belt Path***
- D Cup Holder***
- E Lower Anchor Attachment***
- F Booster Lap Belt Path***
- G Rear-Facing Belt Path***
- H Base***

2 Features

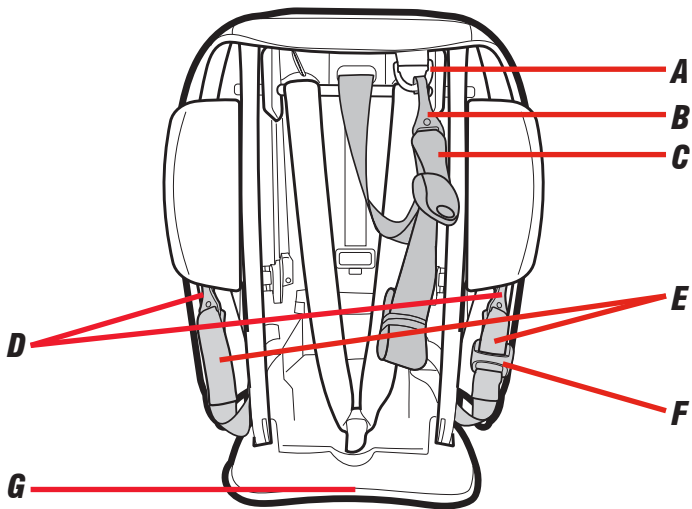

- A Tether Storage Ring***
- B Tether Hook***
- C Tether Strap***
- D Lower Anchor Connector Storage***
- E Lower Anchor Strap***
- F Lower Anchor Adjuster***
- G Instruction Manual Storage***



2 Features

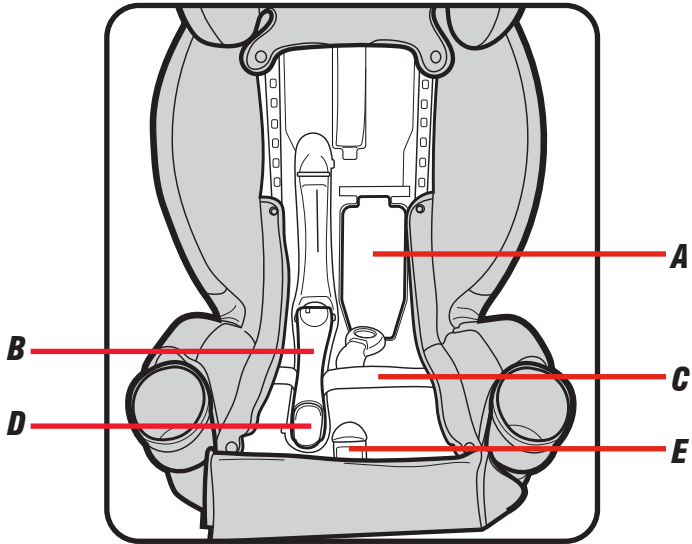

- A Harness Storage Compartment***
- B SnugLock® Lock-Off***
- C Lower Anchor Strap***
- D SnugLock® Lock-Off Release Button***
- E Harness Release Lever***



3-A Rear-Facing Use

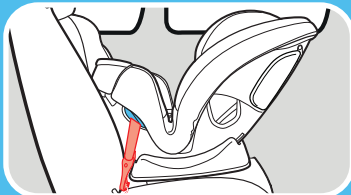

Lower Anchor Attachment

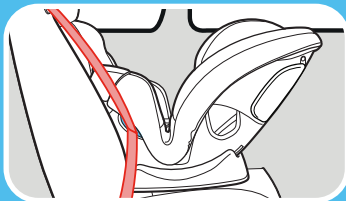

Vehicle Seat Lap/Shoulder Belt

Rear-Facing: 5-40 lb (2.2-18 kg) and whose head is at least 1" (2.5 cm) below the headrest adjustment handle

- Infants who weigh less than 26.5 lb (12 kg) **MUST be rear-facing.**
- Place car seat rear-facing in the vehicle back seat.
- Make sure the lower anchor strap or vehicle seat belt is routed through the rear-facing belt path marked with a blue label.
- Install this car seat tightly in your vehicle. Car seat **should not move** at the rear-facing belt path more than 1" (2.5 cm) from side to side, front to back.
- The red level line on the side of the seat **MUST BE LEVEL** with the ground.



3 Rear Facing

- Harness straps need to be **even with or just below** the top of child's shoulders and chest clip is at **armpit level**.

Children are safer riding rear-facing and should ride rear-facing as long as possible, until they reach the maximum rear-facing height or weight rating for their car seat. Then children should ride forward-facing, using the built-in harness system for as long as possible until they reach the maximum forward-facing weight or height for their car seat. Be sure to check your local and state laws, as well as AAP and NHTSA recommendations, for car seat usage.

⚠ WARNING!



NEVER place this child restraint rear-facing in a vehicle seating location that has an active front air bag.

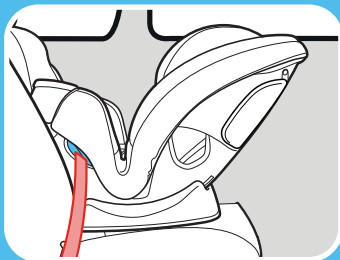

Vehicle Seat Lap Belt



**3 Rear
Facing**

3-B Installing Rear-Facing With Lower Anchors

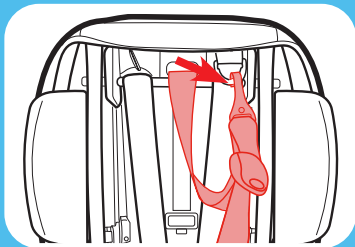

Visit www.gracobaby.com and the TrioGrow™ SnugLock® car seat product page to view installation videos.

1. Store Tether

Attach tether hook to the plastic bar on right side of the car seat.

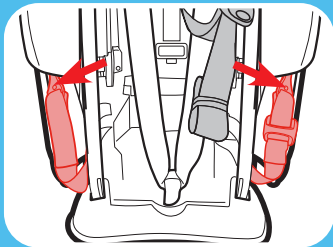

2. Remove Lower Anchor Connectors from Storage Location

Unhook the lower anchor connectors and remove from storage position.



3 Rear Facing

3. Make Sure Lower Anchor Strap is in the Rear-Facing Belt Path Marked With a Blue Label

If not, See section 8 to move lower anchor attachment.

4. Recline the Car Seat

Pull out on handle on front of child restraint and adjust to one of the three rear-facing positions.

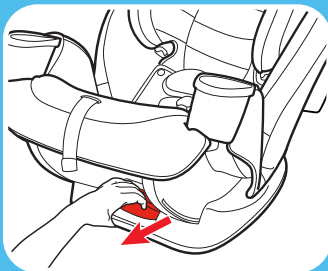
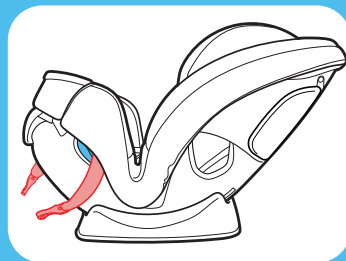
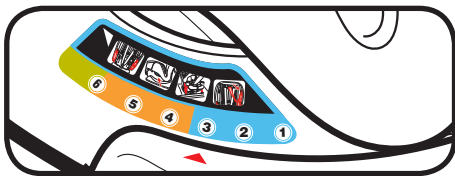

3 Rear Facing

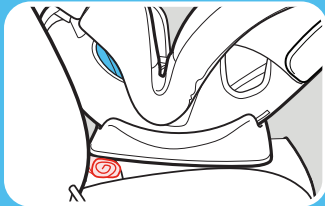
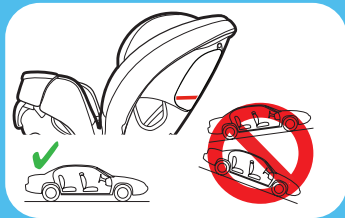
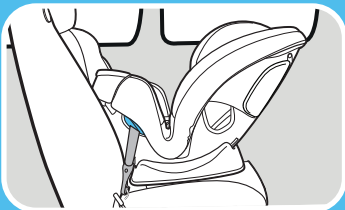

5. **Place Car Seat Rear-Facing in Back Seat of the Vehicle**

Place rear-facing in vehicle seat and center the car seat between the lower anchors. The base should sit as flat as possible on the vehicle seat.

Note: Make Sure Base is a minimum of 80% on Vehicle Seat.

6. **Check the Level Line**

The red level line on the side of the seat **MUST BE LEVEL** with the ground. Readjust the recline if needed.

If needed, rolled towels may be placed under the car seat at the vehicle seat crease, until the level line is level with the ground.

7. Extend the Lower Anchor Strap.

For easier installation, extend the lower anchor strap to its maximum length by pressing the grey button and pulling on the strap.

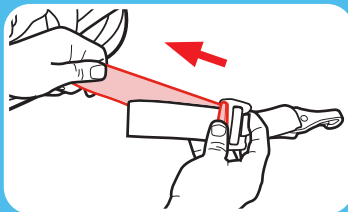

8. Expose the SnugLock® Lock-Off

A. Loosen the harness straps. Push down on the harness release lever while pulling out on the harness straps at the chest clip.

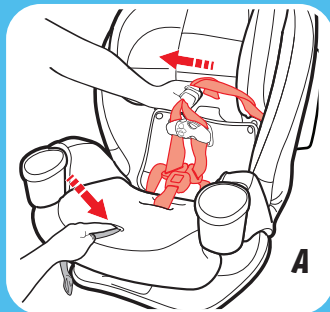

3 Rear
Facing



3 Rear
Facing

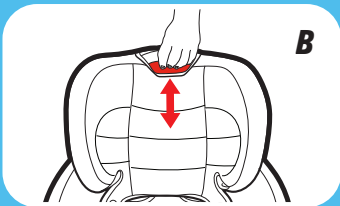

B. Raise the headrest to the highest position.

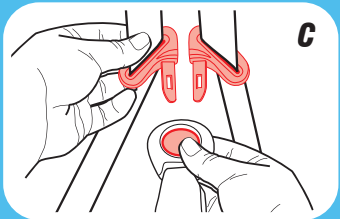

C. Unbuckle the buckle.

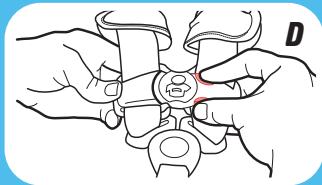

D. Unbuckle the chest clip.

E. Unsnap Seat Pad

Undo the 2 snaps.

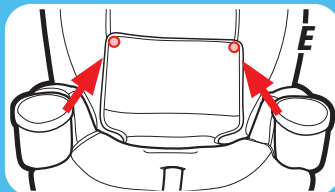

F. Pull Bottom Seat Pad Back To Expose the Plastic Shell

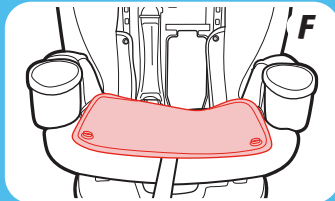

G. Lift the headrest pad flap up out of the way.

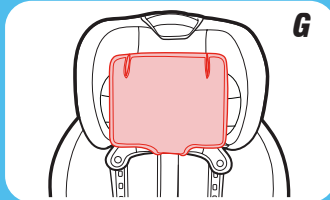

3 Rear Facing

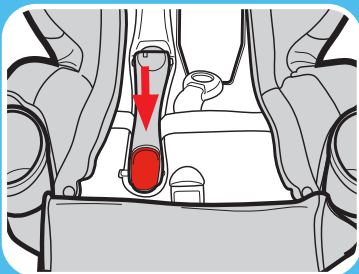

9. Open the SnugLock® Lock-Off

Push the lever to open the SnugLock® lock-off.



10. Rotate the SnugLock® lock-off if needed

If the SnugLock® Lock-off is in the forward-facing belt path, rotate down toward the rear-facing belt path.

Proceed to the next step if the SnugLock® Lock-off is already in the rear-facing belt path.



**3 Rear
Facing**

11. Make Sure the Lower Anchor strap is Routed Under the SnugLock® Lock-Off

The lower anchor strap should lie as flat as possible and not be twisted.

Make sure the lower anchor strap is in front of the buckle strap when the buckle is in the inner-most position, and behind when in the outer-most position.

12. Attach Lower Anchor Connectors to Vehicle's Lower Anchors.

Strap should lie flat and not be twisted.

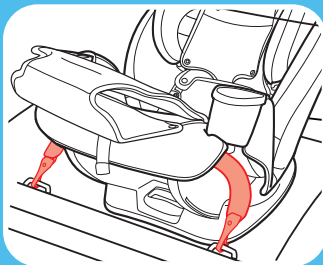
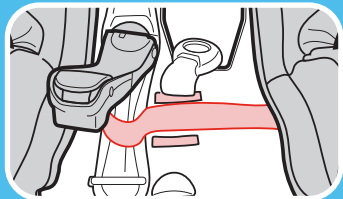
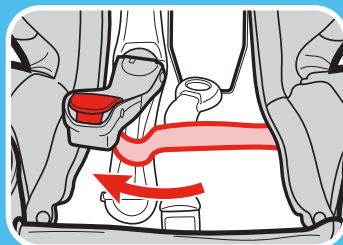
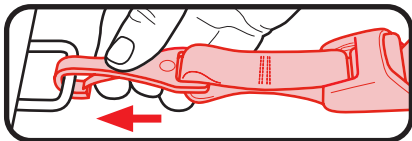

**3 Rear
Facing**

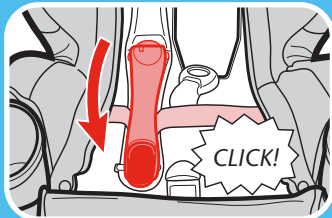
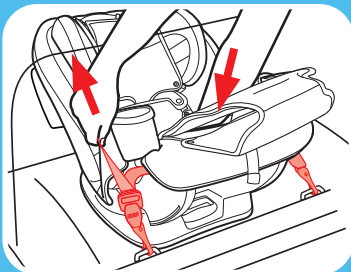

⚠ WARNING!

Use Caution when closing the lock off. Keep hands and other foreign objects away from the locking area.

13. Tighten the Lower Anchor strap

Press down firmly in the center of the car seat while tightening the lower anchor strap to remove all the slack. Do not pull on the strap with excessive force.

You may need to tighten through the rear-facing belt path as shown.

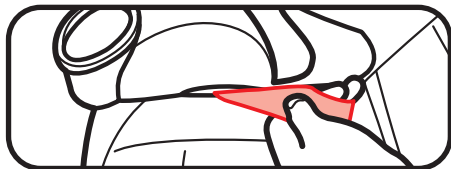

14. Close the SnugLock® Lock-Off

When the slack is removed, close the SnugLock® Lock-Off until you hear a “Click”. Make sure the Lower Anchor strap is under the SnugLock® Lock-Off.



3 Rear Facing

15. Test For Tightness

Grab the sides of the seat where the lower anchor attachment is and slide the car seat side-to-side and front-to-back.

If the seat moves less than 1" (2.5 cm), it is tight enough.

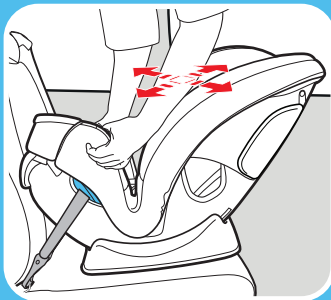

16. Replace the Seat Pad

Move the headrest back to its proper position for your child.



**3 Rear
Facing**



3 Rear
Facing

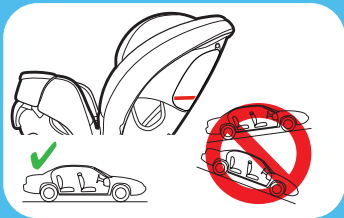

17. Check the Level Line

The red level line on the side of the seat **MUST BE LEVEL** with the ground. Readjust the recline if needed.

If needed, rolled towels may be placed under the car seat at the vehicle seat crease, until the level line is level with the ground.

See section 6 to secure your child.
Recheck level line with child in seat.

Is Everything Correct?

Car Seat Does Not Move More than 1" (2.5 cm) at the Belt Path

The red level line MUST BE LEVEL with the ground



Harness Straps at or Just Below the Child's Shoulders.

Review section 6

Chest Clip Even With Armpits

Review section 6

Cannot Pinch Harness Straps at the Shoulder

Review section 6

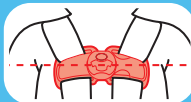
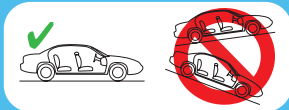
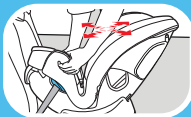

**3 Rear
Facing**

3-C Install Rear-Facing with Vehicle Seat Belt

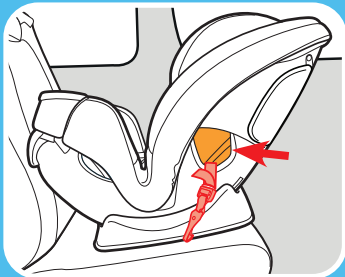

Visit www.gracobaby.com and the TrioGrow™ SnugLock® car seat product page to view installation videos.

- 1. Make Sure Lower Anchor Attachment is in the Forward-Facing Belt Path Marked with Orange Label**

If not, see section 8 to move lower anchor attachment.

- 2. Store Tether and Lower Anchor Connectors**

Attach tether hook and lower anchor connectors to the plastic bars as shown.

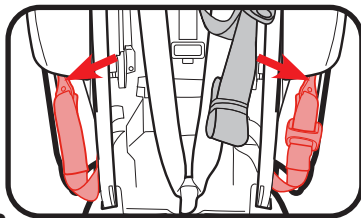
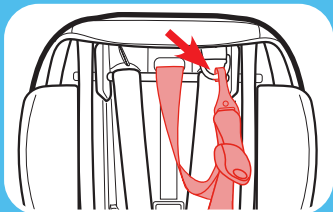

3 Rear Facing

3. **Recline the Car Seat**

Pull out on handle on front of child restraint and adjust to one of the three rear-facing positions.

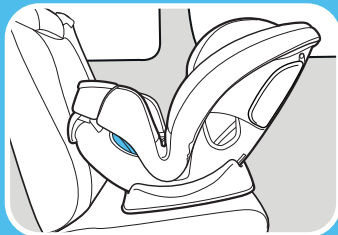
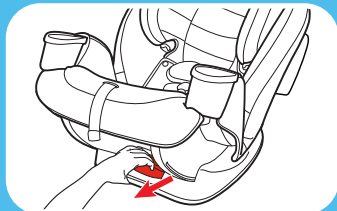

4. **Place Car Seat Rear-Facing in Back Seat of the Vehicle**

Place rear-facing in vehicle seat. The base should sit as flat as possible on the vehicle seat.

Note: Make Sure Base is a minimum of 80% on Vehicle Seat.



3 Rear Facing

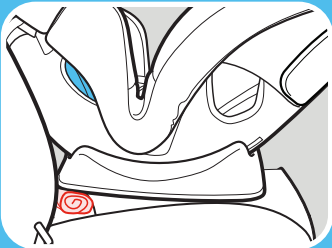
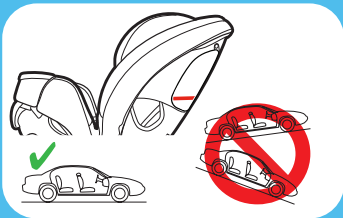

5. Check the Level Line

The red level line on the side of the seat **MUST BE LEVEL** with the ground. Readjust the recline if needed.

If needed, rolled towels may be placed under the car seat at the vehicle seat crease, until the level line is level with the ground.

See section 6 to secure your child.
Recheck level line with child in seat.

6. Expose the SnugLock® Lock-Off

A. Loosen the harness straps. Push down on the harness release lever while pulling out on the harness straps at the chest clip.

B. Raise the headrest to the highest position.

C. Unbuckle the buckle.

D. Unbuckle the chest clip.

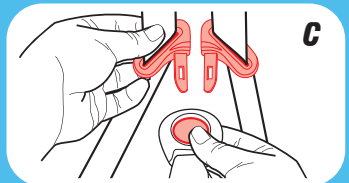
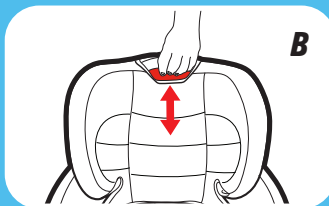
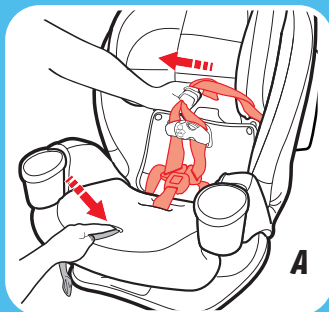
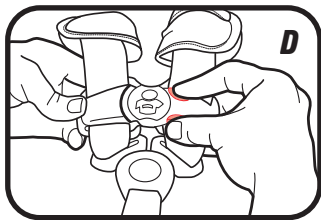

**3 Rear
Facing**



3 Rear
Facing

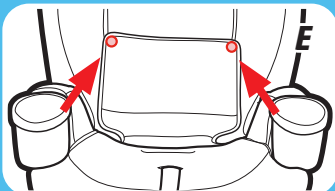

E. Unsnap Seat Pad

Undo the 2 snaps.

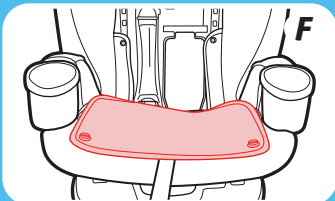

F. Pull Bottom Seat Pad Back To Expose the Plastic Shell

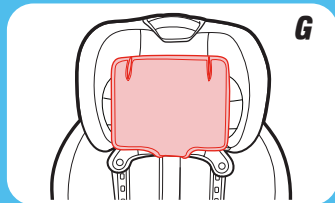

G. Lift the headrest pad flap up out of the way.

7. Open the SnugLock® Lock-Off

Push the lever to open the SnugLock® lock-off.

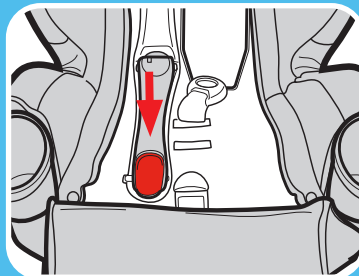

8. Rotate the SnugLock® lock-off if needed

If the SnugLock® Lock-off is in the forward-facing belt path, rotate down toward the rear-facing belt path.

Proceed to the next step if the SnugLock® Lock-off is already in the rear-facing belt path.

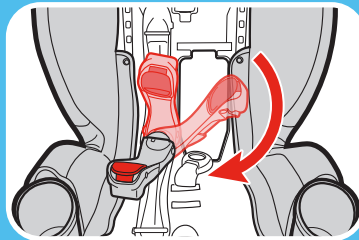

**3 Rear
Facing**

Review your vehicle's owner manual for vehicle seat belt use

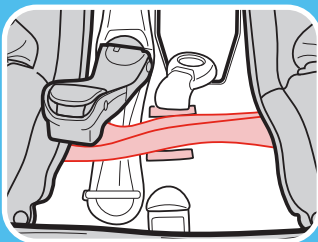
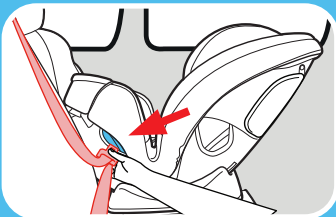

9. Route the Vehicle Seat Belt Under the SnugLock® Lock-off

Thread vehicle seat belt through the rear-facing belt path (marked with a blue label), through the SnugLock® Lock-Off, and out the other side. Buckle the seat belt. The seat belt should lie as flat as possible and not be twisted.

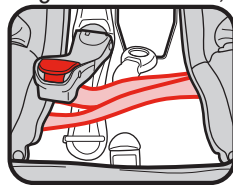

Make sure the vehicle seat belt is in front of the buckle strap when the buckle is in the inner-most position, and behind when in the outer-most position.



**3 Rear
Facing**

10. Tighten the Vehicle Seat Belt

Press down firmly in the center of the car seat. Pull on the shoulder belt to remove slack.

Do not pull on the vehicle seat belt with excessive force.

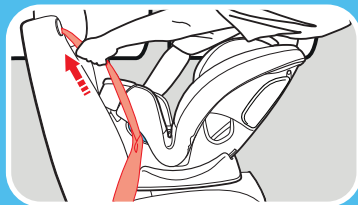

11. Close the SnugLock® Lock-Off

When the slack is removed, close the SnugLock® Lock-Off until you hear a “Click”. Make sure the vehicle seat belt is under the SnugLock® Lock-Off.

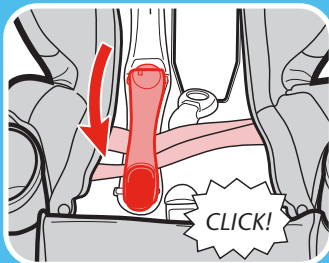

⚠️ WARNING!

Use Caution when closing the lock off. Keep hands and other foreign objects away from the locking area.



**3 Rear
Facing**



3 Rear
Facing

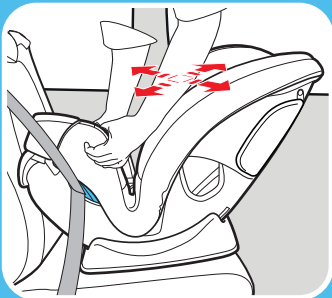

12. Test For Tightness

Grab the sides of the seat where the Lower Anchor strap is and slide the car seat side-to-side and front-to-back.

If the seat moves less than 1" (2.5 cm), it is tight enough.



13. Replace the Seat Pad

Move the headrest back to its proper position for your child.

14. Check the Level Line

The red level line on the side of the seat **MUST BE LEVEL** with the ground. Readjust the recline if needed.

If needed, rolled towels may be placed under the car seat at the vehicle seat crease, until the level line is level with the ground.

See section 6 to secure your child.
Recheck level line with child in seat.

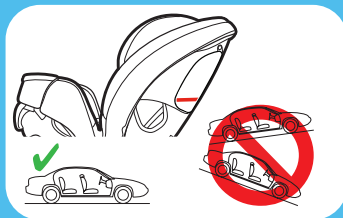

3 Rear
Facing

Is Everything Correct?

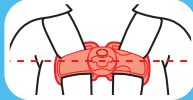
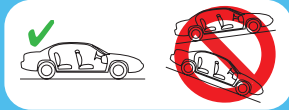

Car Seat Does Not Move More than 1" (2.5 cm) at the Belt Path

The red level line MUST BE LEVEL with the ground



Harness Straps at or Just Below the Child's Shoulders.

Review section 6

Chest Clip Even With Armpits

Review section 6

Cannot Pinch Harness Straps at the Shoulder

Review section 6



3 Rear Facing



4 Forward
Facing

4-A Forward-Facing Use

**Forward-Facing:
26.5-65 lb (12-30 kg)
49 inches (125 cm) or less**



- For children over 40 lb (18 kg) you **MUST** use recline position 5.
- Place car seat forward-facing in the vehicle back seat.
- Make sure lower anchor strap or vehicle seat belt is routed through the forward-facing belt path marked with an orange label.
- Install this car seat tightly in your vehicle. Car seat **should not move** at the forward-facing belt path more than 1". (2.5 cm) from side to side, front to back.

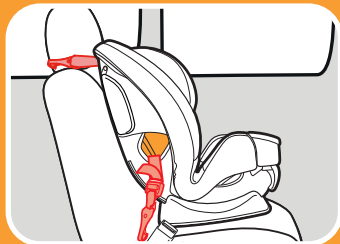

LATCH

***Do not install by this method
for a child weighing more
than 45 lb (20 kg)***



4 Forward Facing

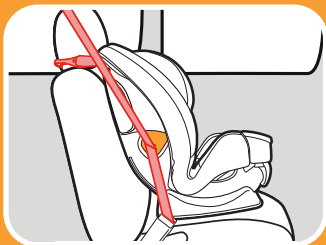

Vehicle Lap/Shoulder Seat Belt with Tether

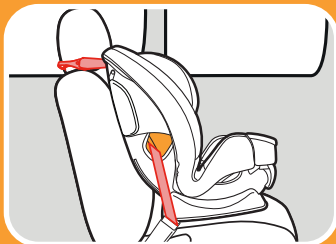

Vehicle Seat Lap Belt With Tether

- Harness straps need to be **even with or just above** the top of child's shoulders and chest clip is at **armpit level**.
- Children are safer riding rear-facing and should ride rear-facing as long as possible, until they reach the maximum rear-facing height or weight rating for their car seat. Then children should ride forward-facing, using the built-in harness system for as long as possible until they reach the maximum forward-facing weight or height for their car seat. At that point, children should ride in a belt-positioning booster seat. Be sure to check your local and state laws, as well as AAP and NHTSA recommendations, for car seat usage.



4 Forward
Facing

4-B Installing Forward-Facing With LATCH

Review your vehicle's owner manual for LATCH location and use. Do not install lower anchors when a child weighs more than 45 lb (20 kg)

Visit www.gracobaby.com and the TrioGrow™ SnugLock® car seat product page to view installation videos.

1. Remove Lower Anchor Connectors from Storage Location

2. Make Sure Lower Anchor Strap is in the Forward-Facing Belt Path Marked with Orange Label

If not, see section 8 to move lower anchor attachment.

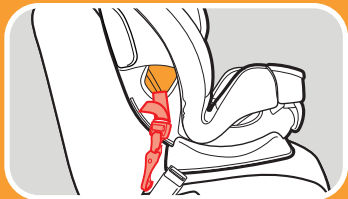
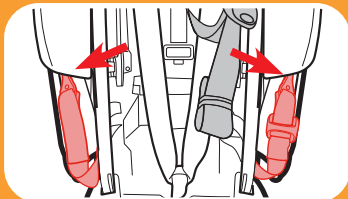

4 Forward
Facing

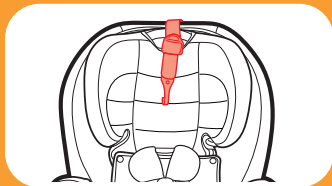
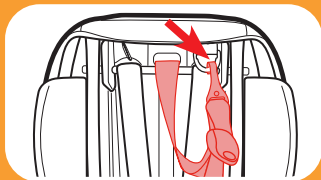
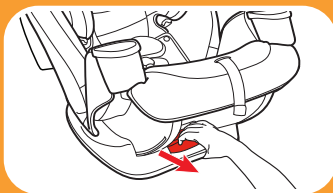

3. Recline the Car Seat

Pull out the recline handle and place the car seat in recline position 4, 5, or 6. **For children over 40 lb (18 kg) you MUST use recline position 5.**



4. Unhook Tether Hook From Storage

Unhook tether and lay it in the seat.

5. Place Car Seat Forward-Facing in Back Seat of the Vehicle

Place forward-facing in vehicle seat and center the car seat between the lower anchors. The base should sit as flat as possible on the vehicle seat.

Note: Make Sure Base is a minimum of 80% on Vehicle Seat.

6. Extend the Lower Anchor Strap.

For easier installation, extend the lower anchor strap to its maximum length by pressing the grey button and pulling on the strap.

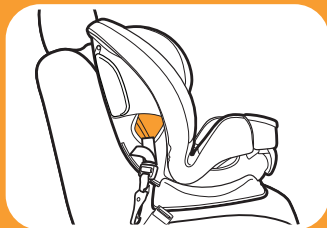

4 Forward Facing

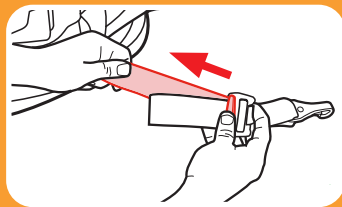

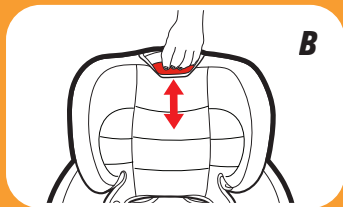
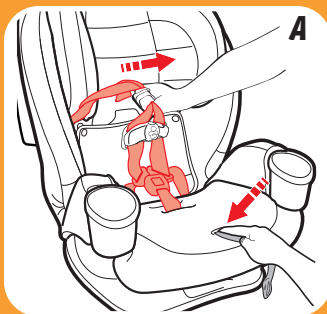

7. Expose the SnugLock® Lock-Off

A. Loosen the harness straps. Push down on the harness release lever while pulling out on the harness straps at the chest clip.

B. Raise the headrest to the highest position.

C. Unbuckle the buckle.

D. Unbuckle the chest clip.

E. Unsnap Seat Pad

Undo the 2 snaps.

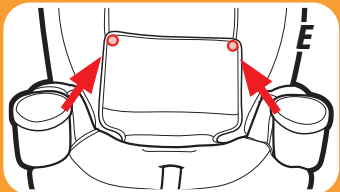
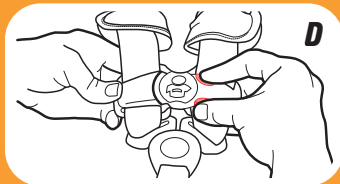
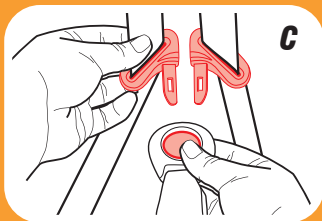

4 Forward Facing

4 Forward
Facing

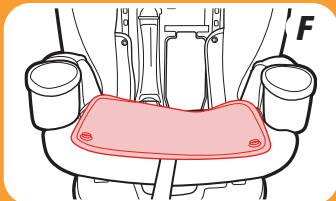

F. Pull Bottom Seat Pad Back To Expose the Plastic Shell

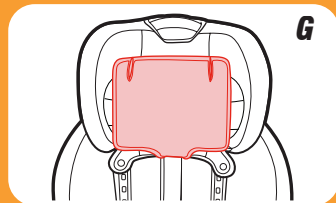

G. Lift the headrest pad flap up out of the way.

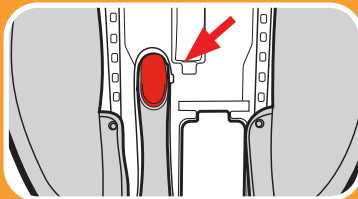

8. Open the SnugLock® Lock-Off
Push the lever to open the SnugLock® lock-off.



4 Forward
Facing

9. Rotate the SnugLock® lock-off if needed

If the SnugLock® Lock-off is in the rear-facing belt path, rotate the SnugLock® Lock-off up toward the forward-facing belt path.

Proceed to the next step if the SnugLock® Lock-off is already in the forward-facing belt path.

10. Make Sure the Lower Anchor Strap is Routed Under the SnugLock® Lock-Off

The lower anchor strap should lie as flat as possible and not be twisted.

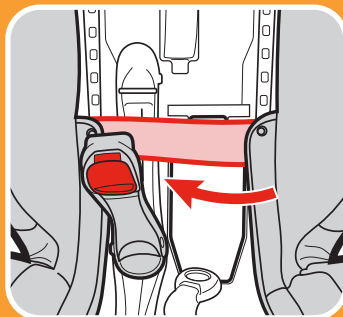
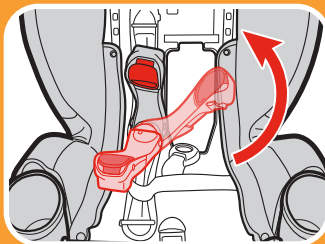

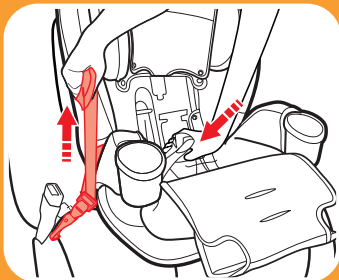
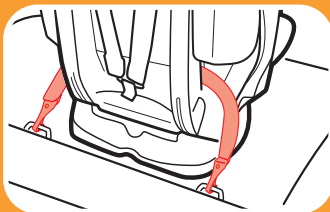

11. Attach Lower Anchor Connectors to Vehicle's Lower Anchors.

Lower anchor strap should not be twisted.

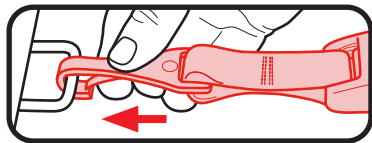

12. Tighten the Lower Anchor Strap

Press down and back firmly in the center of the car seat while tightening the lower anchor strap to remove all the slack. Do not pull on the strap with excessive force.

13. Close the SnugLock® Lock-Off

When the slack is removed, close the SnugLock® Lock-Off until you hear a “Click”. Make sure the Lower Anchor strap is under the SnugLock® Lock-Off.

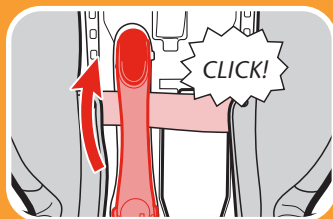

4 Forward
Facing

⚠ WARNING!

Use Caution when closing the lock off. Keep hands and other foreign objects away from the locking area.

14. Attach Tether Hook

Extend the tether by lifting up on the tether lock and attach.



Consult vehicle's owner manual for specific location.

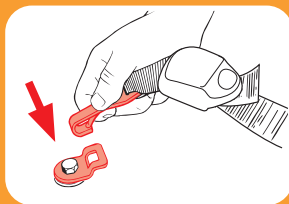



4 Forward
Facing

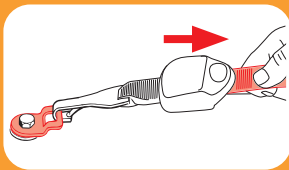

15. Tighten Tether Strap

Remove all the slack.

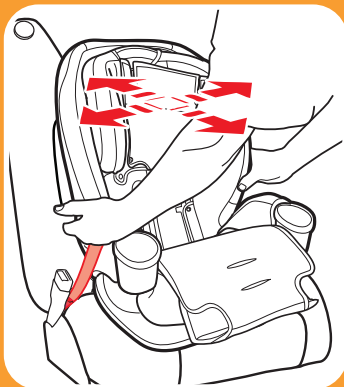

16. Test For Tightness

Grab the sides of the seat where the lower anchor attachment is and slide the car seat side-to-side and front-to-back.

If the seat moves less than 1" (2.5 cm), it is tight enough.

See section 6-A to secure your child.

17. Replace the Seat Pad

Move the headrest back to its proper position for your child.



**4 Forward
Facing**



4 Forward
Facing

Is Everything Correct?

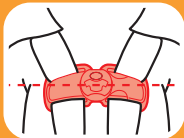
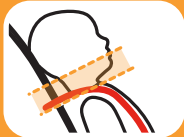

Car Seat Does Not Move More than 1" (2.5 cm) at the Belt Path

Harness Straps at or Just Above the Child's Shoulders.

Review section 6

Chest Clip Even With Armpits

Review section 6

Cannot Pinch Harness Straps at the Shoulder

Review section 6



4-C Install Forward-Facing with Vehicle Seat Belt

Visit www.gracobaby.com and the TrioGrow™ SnugLock® car seat product page to view installation videos.

1. Make Sure Lower Anchor Strap is in the Rear-Facing Belt Path Marked With a Blue Label

If not, See section 8 to move Lower Anchor strap.

2. Store Lower Anchor Connectors

Attach lower anchor connectors to the plastic bars as shown.

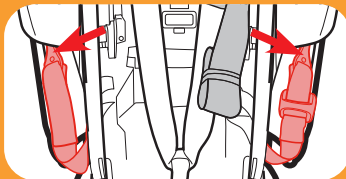
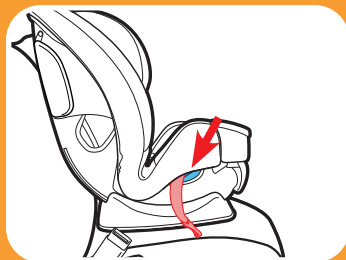

4 Forward Facing

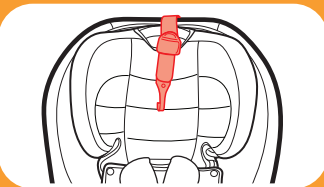
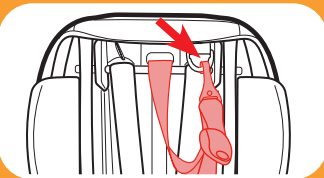

3. Recline the Car Seat

Pull out the recline handle and place the car seat in recline position 4, 5, or 6. **For children over 40 lb (18 kg) you MUST use recline position 5.**

4. Unhook Tether Hook From Storage

Unhook tether and lay it in the seat.

5. Place Car Seat Forward-Facing in Back Seat of the Vehicle

Place forward-facing in vehicle seat. The base should sit as flat as possible on the vehicle seat.

Note: Make Sure Base is a minimum of 80% on Vehicle Seat.

6. Expose the SnugLock® Lock-Off

A. Loosen the harness straps. Push down on the harness release lever while pulling out on the harness straps at the chest clip.

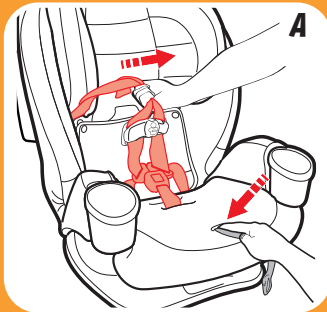
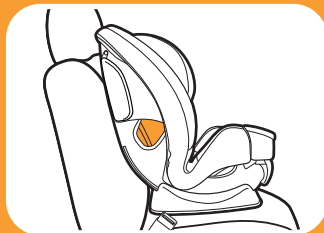

4 Forward Facing

4 Forward
Facing

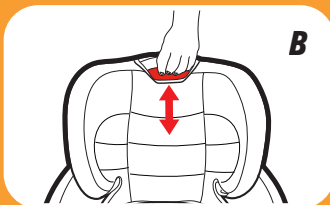

B. Raise the headrest to the highest position.

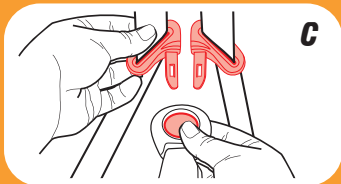

C. Unbuckle the buckle.

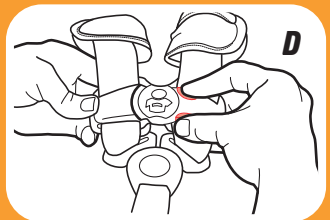

D. Unbuckle the chest clip.

E. Unsnap Seat Pad

Undo the 2 snaps.

F. Pull Bottom Seat Pad Back To Expose the Plastic Shell

G. Lift the headrest pad flap up out of the way.

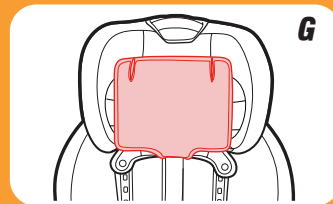
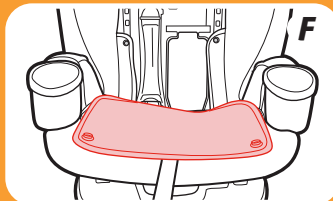
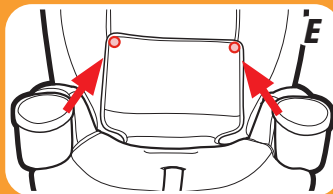

4 Forward Facing

4 Forward
Facing

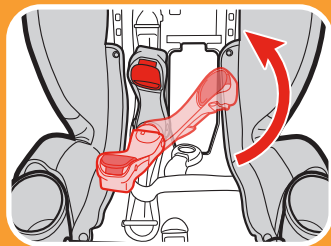
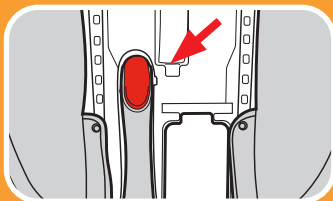

7. Open the SnugLock® Lock-Off

Push the lever to open the SnugLock® lock-off.

8. Rotate the SnugLock® lock-off if needed

If the SnugLock® lock-off arm is in the rear-facing belt path, rotate the arm up toward the forward-facing belt path.

Proceed to the next step if the lock-off arm is already in the forward-facing belt path.

Review your vehicle's owner manual for vehicle seat belt use



4 Forward Facing

9. Route the Vehicle Seat Belt

Thread vehicle seat belt through the forward-facing belt path (marked with an orange label), under the SnugLock® Lock-Off, and out the other side. Buckle the seat belt. The seat belt should lie as flat as possible and not be twisted.

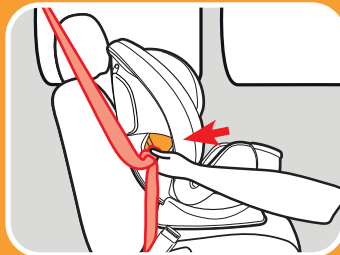
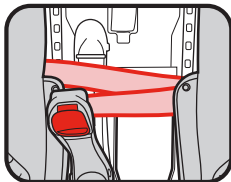

10. Tighten the Vehicle Seat Belt

Press down and back firmly in the center of the car seat. Pull on the shoulder belt to tighten while feeding the slack back in the retractor. Do not pull on the strap with excessive force.

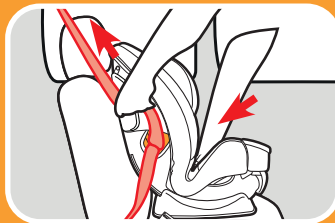

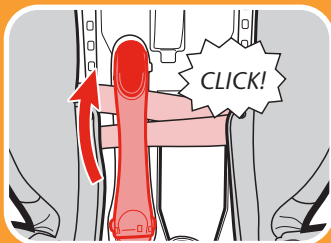

11. Close the SnugLock® Lock-Off

When the slack is removed, close the SnugLock® Lock-Off until you hear a “Click”. Make sure the vehicle seat belt is under the SnugLock® Lock-Off.

! WARNING!

Use Caution when closing the lock off. Keep hands and other foreign objects away from the locking area.

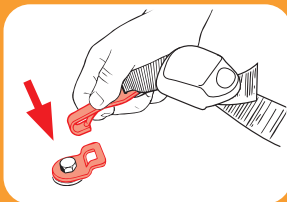

12. Attach Tether Hook

Extend the tether by lifting up on the tether lock and attach.



Consult vehicle’s owner manual for specific location.

13. Tighten the Tether Strap

Push the car seat back while tightening the tether strap to remove all the slack.

14. Test For Tightness

Grab the sides of the seat where the vehicle seat belt is and slide the car seat side-to-side and front-to-back.

If the seat moves less than 1" (2.5 cm), it is tight enough.

See section 6-A to secure your child.

15. Replace the Seat Pad

Move the headrest back to its proper position for your child.

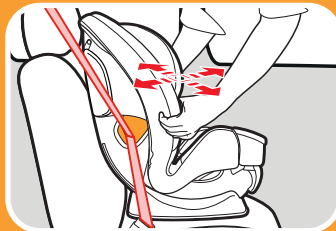
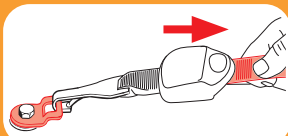

**4 Forward
Facing**



4 Forward
Facing

Is Everything Correct?

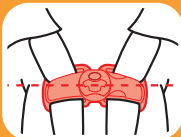
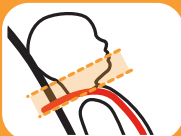

Car Seat Does Not Move More than 1" (2.5 cm) at the Belt Path

Harness Straps at or Just Above the Child's Shoulders.

Review section 6

Chest Clip Even With Armpits

Review section 6

Cannot Pinch Harness Straps at the Shoulder

Review section 6

5-A Booster Use

Booster Use:

40-100 lb (18.1-45 kg)

43-57 in. (110.1-145 cm)

at least 4 years old



- Place car seat forward-facing in the vehicle back seat.
- Make sure vehicle seat's lap belt is adjusted snugly and lays low on the child's hip and is routed behind the armrest in the booster's belt path.
- Vehicle belts **MUST** lie flat against child and **MUST NOT** be twisted.
- Vehicle seat's shoulder belt is adjusted snugly and should lie between child's neck and edge of shoulder.
- **Never** use a vehicle lap-only belt across front of child.
- **DO NOT** position vehicle shoulder belt



Vehicle Lap/Shoulder Seat Belt



5 Booster



**Never Use a Vehicle
Lap-Only Belt Across
Front of Child**

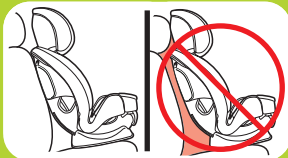

- under the child's arm or back.
- **DO NOT** allow child to slouch or slide down in the booster seat.
- **DO NOT** position vehicle belt over top of armrests.
- Vehicle's seat headrest **SHOULD NOT** create a gap between vehicle seat and booster seat.
- The front of booster seat **MUST NOT** hang over front of vehicle seat.
- If child will not keep vehicle belt properly positioned, **DO NOT** use this booster seat. Use a different car seat.

When forward-facing, children should use the built-in harness system for as long as possible until they reach the maximum forward-facing weight or height for their car seat. At that point, children should ride in a belt-positioning booster seat. A booster is no longer needed once the vehicle seat belt fits properly, typically when they reach 4 feet 9 inches (145 mm) tall and are between ages 8-12. Be sure to check your local and state laws, as well as AAP and NHTSA recommendations, for car seat usage.

5-B Install Highback Booster

1. Store The Harness System

A. Remove Harness Covers

To remove, undo the fastening strips and remove.

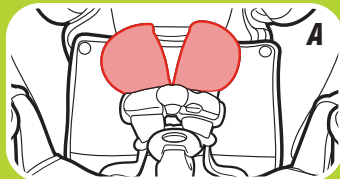

B. Loosen The Shoulder Straps As Much As Possible.

Push down on the harness release lever while pulling out on the harness straps at the chest clip.

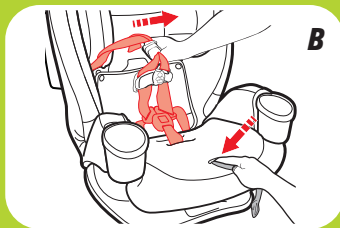

C. Raise The Headrest To The Highest Position.

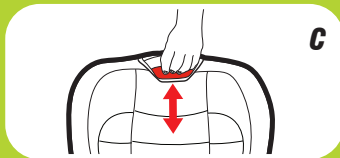

 5 Booster



5 Booster

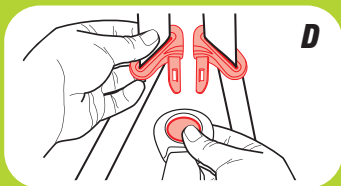

D. Unbuckle the buckle.

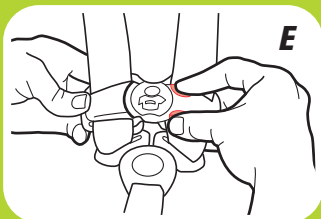

E. Unbuckle the chest clip.

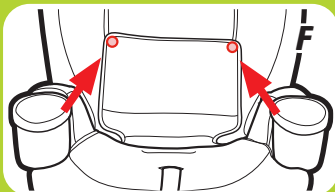

F. Unsnap Seat Pad
Undo the 2 snaps.

G. Pull Bottom Seat Pad Back To Expose the Plastic Shell

H. Lift the headrest pad flap up out of the way.

I. Remove the Buckle Strap

From bottom of car seat, rotate metal retainer to side in order to push it through slot easier.

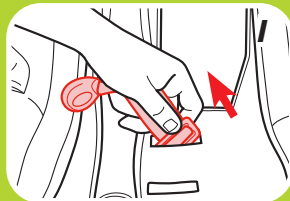
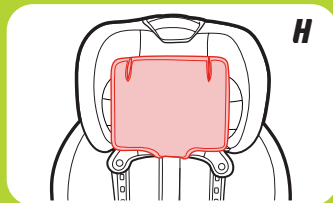
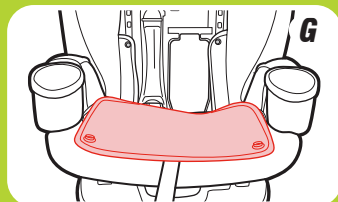
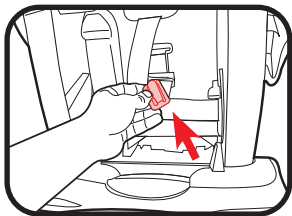



5 Booster

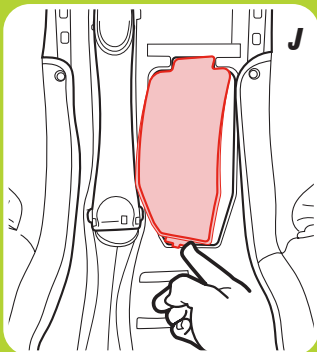

5 Booster

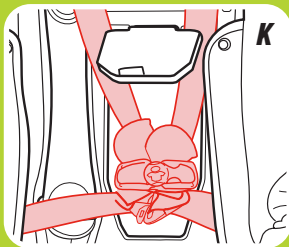

J. Open the Harness Storage Door



K. Place Harness, Chest Clip, Buckle Tongues, Buckle and Harness Covers Inside Storage Compartment and Close the Door

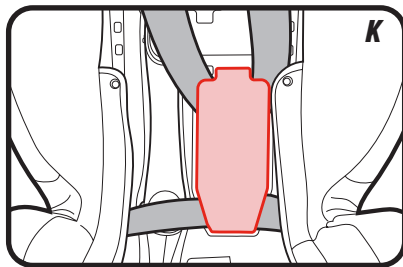

L. Replace Seat Pad

Move the headrest back to its proper position for your child.

2. Adjust the Car Seat

Place car seat in recline position 6.

3. Place Car Seat Forward-Facing in Back Seat of the Vehicle

Place forward-facing in vehicle seat. The bottom of the seat should sit as flat as possible on the vehicle seat. Make sure the base **completely** rests on the vehicle seat.

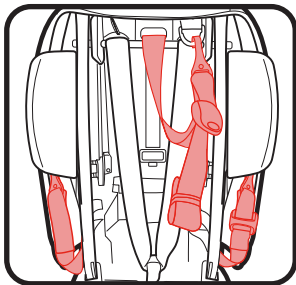

5 Booster

Skip to Step 19 on page 101 if Not Using LATCH

Graco allows the securing of the car seat with LATCH system in the booster mode. The child still **MUST BE SECURED** with the vehicle lap/shoulder seat belt. LATCH can be used in the booster mode regardless of the weight of the child up to 100 lb (45 kg).

Verify the following before using LATCH in the booster mode:

- The lower anchor attachment **DOES NOT** interfere with any vehicle seat belts or buckles.

If the lower anchor attachment interferes with the vehicle seat belts or if the chosen seating position does not have lower anchors, you **MUST** store the lower anchor connectors. Store the lower anchor connectors by attaching to the plastic bars as shown. Store the tether as shown. Always secure car seat with LATCH or a vehicle seat belt, even when unoccupied. In a crash, an unsecured car seat can injure passengers.

4. Remove Lower Anchor Connectors from Storage Location

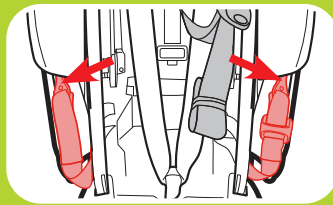

5. Make Sure Lower Anchor Strap is in the Forward-Facing Belt Path Marked with Orange Label

If not, See section 8 to move lower anchor attachment.

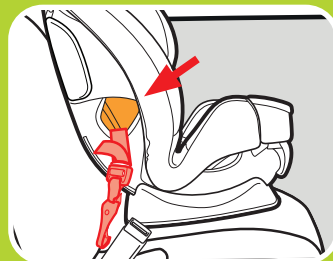

5 Booster

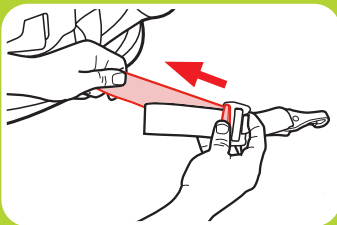
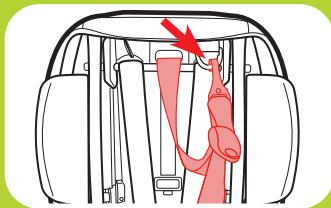

6. Unhook Tether From Storage Location and Lay it in the Seat

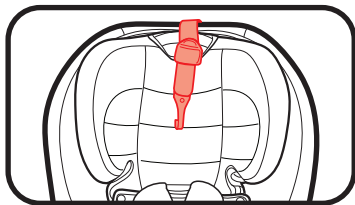

7. Extend the Lower Anchor Strap.

For easier installation, extend the Lower Anchor strap to its maximum length by pressing the grey button and pulling on the strap.

8. Expose the SnugLock® Lock-Off

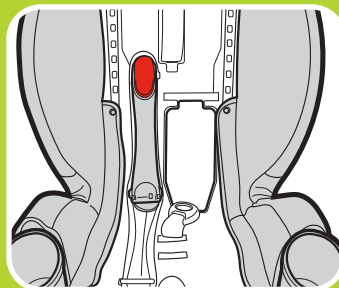

9. Open the SnugLock® Lock-Off

Push the lever to open the SnugLock® lock-off.

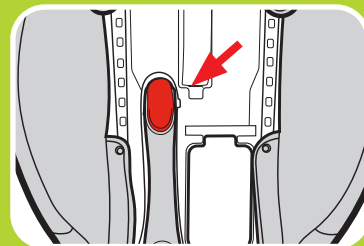

5 Booster

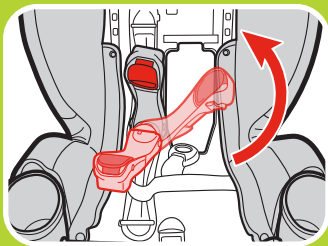

10. Rotate the SnugLock® Lock-off if needed

If the SnugLock® Lock-off arm is in the rear-facing belt path, rotate the arm up toward the forward-facing belt path.

Proceed to the next step if the lock-off arm is already in the forward-facing belt path.

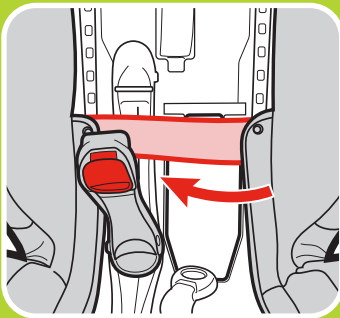

11. Make Sure the Lower Anchor Strap is Routed Under the SnugLock® Lock-Off

The lower anchor strap should lie as flat as possible and not be twisted.

12. Attach Lower Anchor Connectors to Vehicle's Lower Anchors.

Lower Anchor strap should not be twisted.

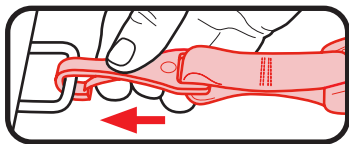

13. Tighten the Lower Anchor Strap

Remove all the slack from the lower anchor strap.

Do not pull on the strap with excessive force.

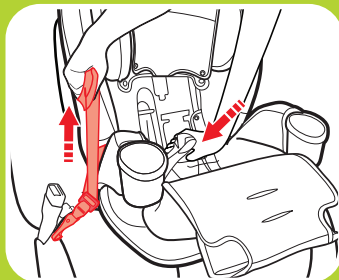
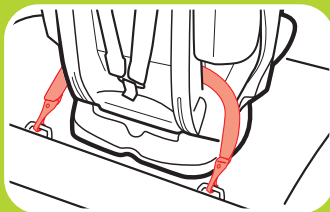

5 Booster

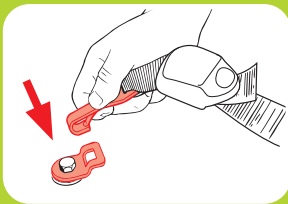
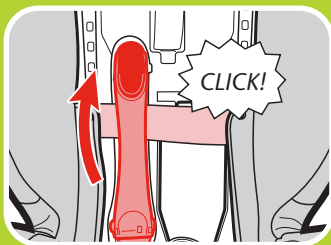

14. Close the SnugLock® Lock-Off

When the slack is removed, close the SnugLock® Lock-Off until you hear a “Click”. Make sure the Lower Anchor strap is under the SnugLock® Lock-Off.

! WARNING!

Use Caution when closing the lock off. Keep hands and other foreign objects away from the locking area.

15. Attach Tether Hook

Extend the tether by lifting up on the tether lock and attach.



Consult vehicle’s owner manual for specific location.

16. Tighten Tether Strap

Remove all the slack.

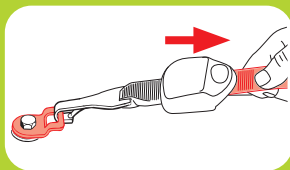

17. Test For Tightness

Grab the sides of the seat where the Lower Anchor strap is and slide the car seat side-to-side and front-to-back.

If the seat moves less than 1" (2.5 cm), it is tight enough.

See section 6-B to secure your child.

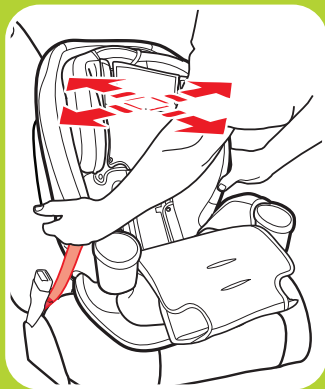

5 Booster



5 Booster

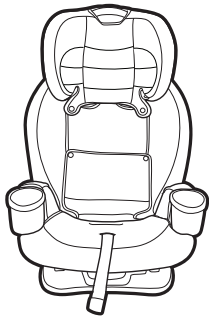

18. Replace the Seat Pad

Move the headrest back to its proper position for your child.

**19. Thread the Vehicle Seat
Shoulder Belt Through Seat
Belt Guide on the Headrest**

See section 6-B to secure your
child.

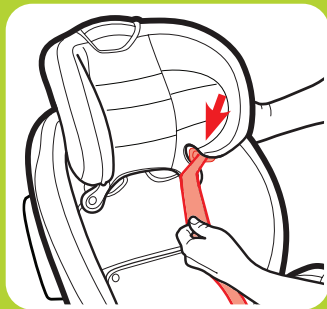

5 Booster

!WARNING!

WARNING! In cold weather, do not put snowsuits or bulky garments on your child when placing them in the car seat. Bulky clothing can prevent the harness straps from being tightened properly. To keep child warm, buckle your child in the car seat and place a blanket around the child or place the child's coat on backwards after buckling in.



6-A Securing Child 5-point Harness

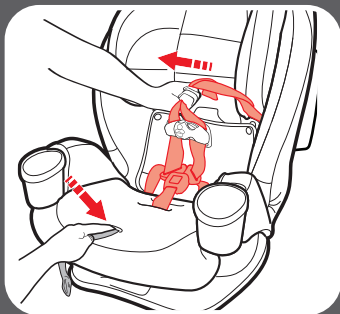

1. Loosen Harness Straps

Push down on the harness release lever while pulling out on the harness straps at the chest clip.

Unbuckle the chest clip and the crotch buckle. Place harness straps off to the sides.

2. Place Your Child in the Seat

Make sure their back is flat against the car seat back.

Avoid bulky or heavy clothing. Doing so will prevent the harness straps from being tightened properly. You may place a blanket over the child after you have secured the child.

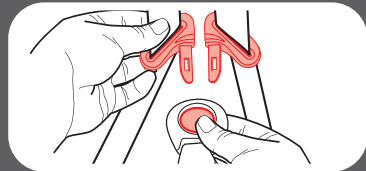
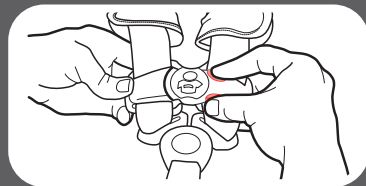

**6 Securing
Child**



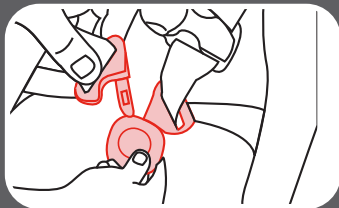

Rear-Facing

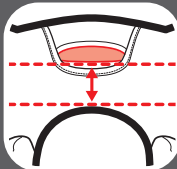

Forward-Facing



3. Place Harness Straps Over Child's Shoulders and Buckle

You will hear a “click” when buckle tongues are securely attached. Pull up on each buckle tongue to make sure it is securely attached.

4. Be Sure the Harness Straps Are at the Proper Height

Rear-Facing: Harness straps should be **at or just below** the child's shoulders. Top of head **must be at least 1” (2.5 cm) below** the headrest adjustment lever.

Forward-Facing: Harness straps should be **at or just above** the child's shoulders. Top of child's ears **below** top of headrest.

5. To Raise or Lower Headrest/ Harness Height

Squeeze the adjustment handle and move headrest for the proper harness height.

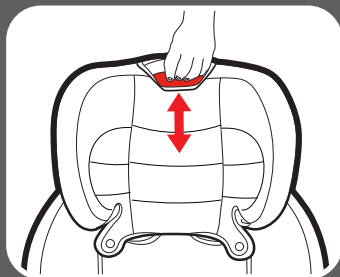

6. Check the Buckle Position

The correct slot is the one that is closest to your child without being underneath them.

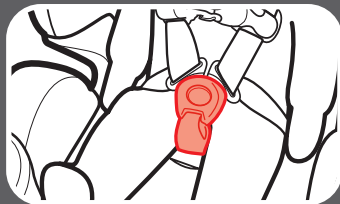

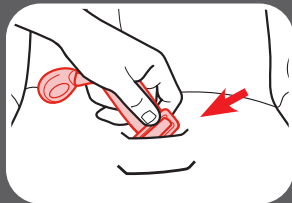
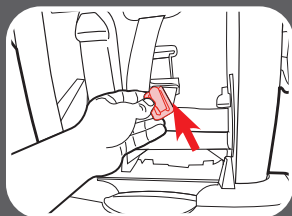
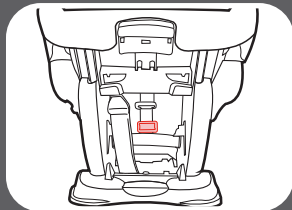

7. To Adjust the Buckle Position

Recline the car seat and locate the metal retainer under the car seat shell.

8. Rotate Metal Retainer and Insert It Up Through the Shell and Pad

From the top of the car seat, pull the crotch buckle out.

9. Insert Metal Retainer in the New Crotch Buckle Slot

Reach underneath the car seat and pull the metal retainer through.

10. Pull Up on Crotch Strap to Make Sure it is Secured

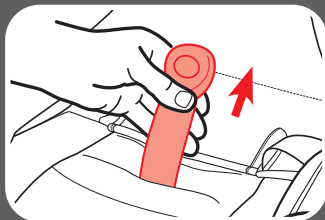

11. Rear-Facing With Lower Anchor Attachment:

Attachment: Make sure the lower anchor strap is **(A)** in front of the buckle strap when the buckle is in the inner-most position, and **(B)** behind when in the outermost position and that it is flat and is not twisted.

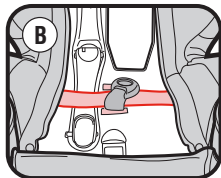
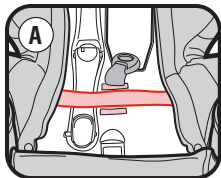

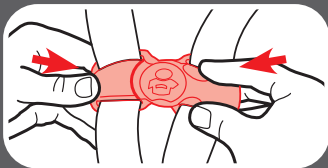

12. Buckle the Chest Clip

You will hear a “click” when the chest clip is securely buckled.

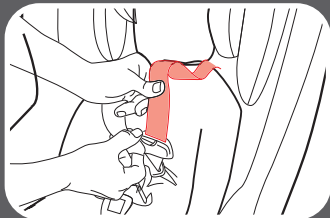

13. Pull All the Slack Out From Around the Waist

Pull up on the harness strap while pushing the chest clip down. Do this to both sides.

14. Tighten the Harness by Pulling the Harness Adjustment Strap

When you are not able to pinch any of the harness webbing at your child's shoulder, the harness is tight enough.

A snug harness should not allow any slack. It lies in a relatively straight line without sagging. It does not press on the child's flesh or push the child's body into an unnatural position.

15. Raise the Chest Clip to Child's Armpit Level

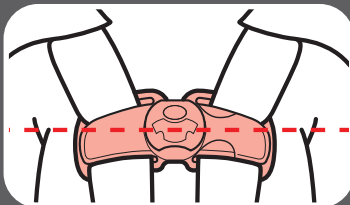
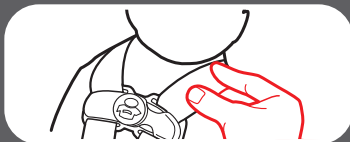
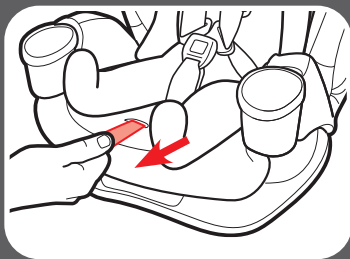

6-B Securing Child Highback Booster

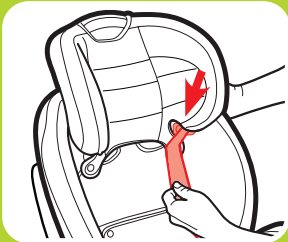

⚠ WARNING!

Warning! Use only the vehicle lap and shoulder belt system when restraining the child in the booster seat.

1. Place Child In Seat

Have your child sit in the booster seat, with his/her back flat against the back of the booster seat.

2. Thread Vehicle's Shoulder Belt Into Seat Belt Guide in the Headrest



3. Buckle the Vehicle Lap/Shoulder Seat Belt

Be sure the lap portion of the vehicle seat belt goes behind the armrests.



Be sure the lap portion of the vehicle seat belt lies low across your child's hips.

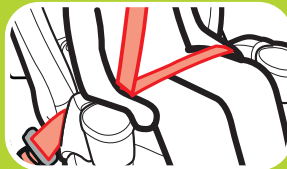

Be sure the shoulder belt lies across your child's shoulder, between the neck and edge of shoulder. The belt guides should be even with or just above the shoulders.



Is Everything Correct?



Never Use Lap Belt Only

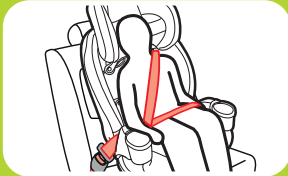

Lap Belt Behind Armrest and Lies Low Across Hips and Thighs



Shoulder Belt Lies On the Shoulder, Between the Neck and Edge of Shoulder

7-A Accessories

Head support and body support can be used only for children weighing less than 20 lb (9 kg).

Harness Covers

Make sure that harness covers do not interfere with placement of the chest clip at armpit level.

To remove, undo the fastening strips and remove.

Body Support

Use only in the rear-facing mode.

Body support must be used if shoulders are below the lowest harness setting.

Never allow body support to bunch or fold behind child.

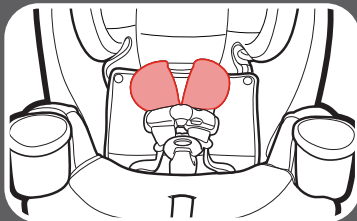

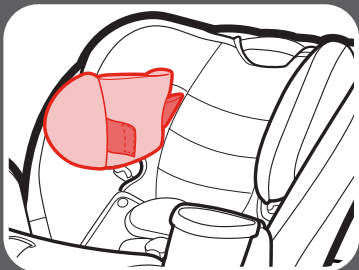
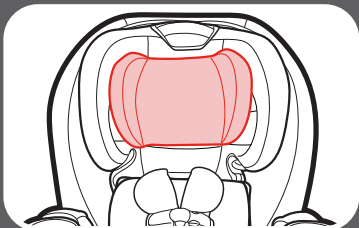

Head Support

Use only in the rear-facing mode. To adjust the support, pull up until desired height. Do not use without the body support.

To install, thread the head support straps through the headrest and use the fastening strips to connect the straps together.

To remove, undo the fastening strips and pull the straps out of the headrest.

8-A Moving Lower Anchor Attachment

1. For Ease of Moving the Lower Anchor Attachment

- A.** Loosen the harness straps.
- B.** Raise the headrest to the highest position.
- C.** Unbuckle the chest clip.
- D.** Unbuckle the buckle.

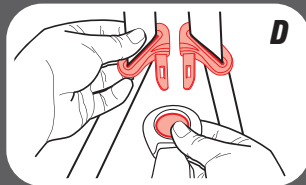
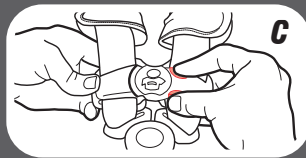
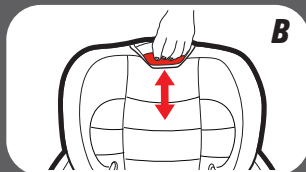
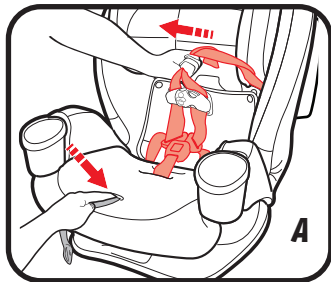

8 Moving
Lower Anchors

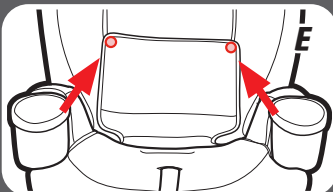

E. Unsnap Seat Pad

Undo the 2 snaps.

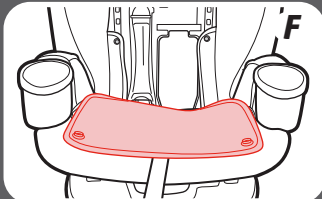

F. Pull Bottom Seat Pad Back To Expose the Plastic Shell

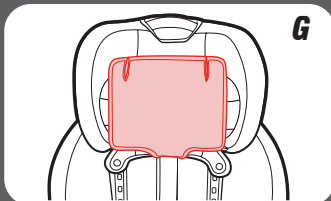

G. Lift the headrest pad flap up out of the way.

2. Pull the Lower Anchor Connectors Out of the Belt Path Openings.

Pull the lower anchor connectors out of the belt path openings, so that the lower anchor connectors lay in the seat.

3. Rotate Lower Anchor Retention Strap Toward the Desired Belt Path Openings

Rear-Facing: Rotate lower anchor retention strap down toward the front of the seat.

Forward-Facing: Rotate lower anchor retention strap up toward the top of the seat.

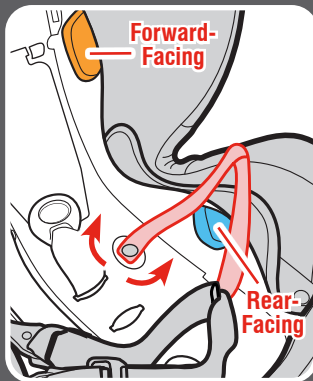
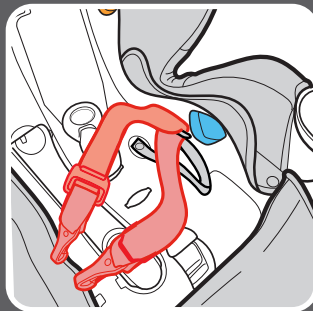

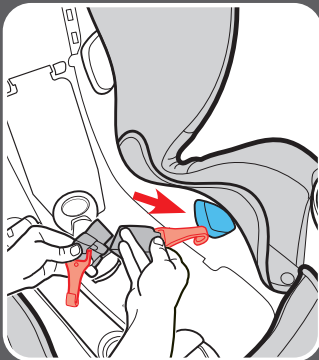

4. Push the Lower Anchor Hooks Out Through the Desired Belt Path Openings on Each Side of Car Seat

Rear-Facing: Make sure the Lower Anchor strap is in front of the buckle strap when the buckle is in the inner-most position (A), and behind when in the outer-most position (B) and that it is flat and is not twisted.

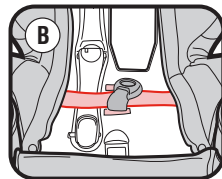
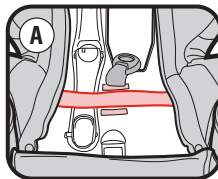

Forward-Facing: Make sure the lower anchor attachment is routed behind the harness strap, is flat, and is not twisted.

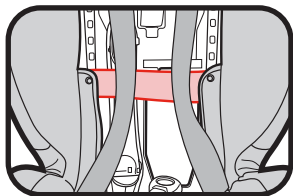

5. Replace the Seat Pad

Move the headrest back to its proper position for your child.

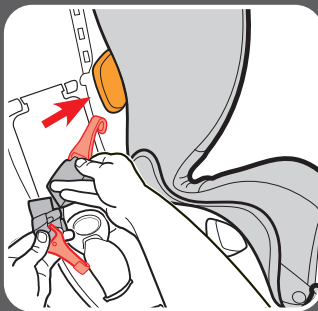

9-A How to Uninstall LATCH

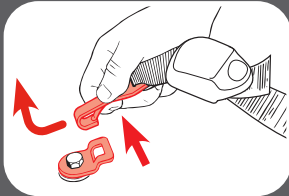
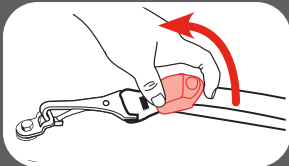
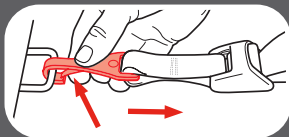

Lower Anchor Connectors

Press in on the hook's spring. Push hook in, lift hook up, twist and pull out away from anchor point.

Tether

To remove, lift up on the tether lock to release the tension.

Press in on the hook's spring. Push tether hook in, then lift up and pull away from tether anchor.

9-B Choosing Vehicle Seat Location

Review your vehicle owner's manual for seating locations.

The best seating location for this car seat is one that:

- Is recommended by your vehicle owner's manual, and
- Results in a secure installation of this car seat

In the event there is no available back seat and / or you have no other option than to place a child in a front passenger seating position (other than rear-facing), the National Highway Traffic Safety Administration (NHTSA) recommends that you take the following steps:

- Ensure the child is properly restrained according to their age and size
- Move the seat as far back as possible
- Make sure the child is not leaning out of position, such as leaning forward into the deployment path of the air bag
- Set the air bag ON-OFF switch, if available, to the OFF position



9-C Unsafe Vehicle Seat Locations

Never install this car seat in any of the following vehicle seating locations:



rear-facing or side-facing
vehicle seats



rear-facing with an
active front air bag



booster mode with vehicle
lap belt only seat belt

9-D Vehicle Seat Belts

Review your vehicle owner's manual for vehicle seat belt use

This car seat can be installed using a vehicle seat belt. To do this, you will need to change the seat belt to a locked mode for use with car seats. With some vehicle seat belts, this is done with the latchplate; with other vehicle seat belts, this is done with the retractor.

Vehicle Seat Belt Terms

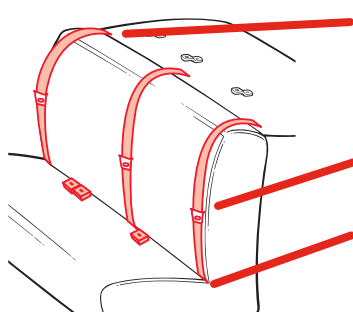

Retractor

A device that winds up the unused vehicle seat belt. It is often hidden inside the panels on the walls of the vehicle or in the vehicle seatback.

Latchplate

The male end of the seat belt with the silver tongue.

Seat Bight

The crease where the vehicle seat back and seat bottom meet.

Identify Your Seat Belt Type

There are two different types of vehicle seat belts that can be used with this car seat:

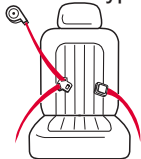

Lap/Shoulder Belt

3 connections points. Can be used in all car seats modes of use.

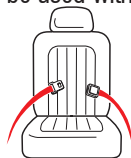

Lap Belt Only

2 connection points. **Can ONLY be used in harness mode.**

The following types of vehicle seat belts **CANNOT** be used safely with this car seat:



Lap Belt with Motorized
Shoulder Belt



Lap Belt or Shoulder
Belt Mounted on Door

Belts Forward of the
Seat Bight



Some vehicles you may not get a secure fit. Read both your vehicle and car seat manuals.

Lap/Shoulder Belt Installation - Rear-Facing/Forward Facing Modes

Always review your vehicle owner's manual for specific information about your vehicle seat belts.

There are three types of retractors: **ELR (Emergency Locking Retractor)**, **ALR (Automatic Locking Retractor)**, and **Switchable (ELR switch to ALR)**. To determine your type of retractor, follow these steps:

1. **Slowly** pull the belt out about halfway and stop.
2. Let the belt retract back several inches.
3. Try to **slowly** pull the belt out more. If the belt cannot be pulled any further, it is **ALR**. If it can be pulled further, go to the next step.
4. **Slowly** pull the belt all the way out, and then allow it to retract several inches.
5. Try to pull the belt all the way out again. If it cannot be pulled out, it is **Switchable**. If it can still be pulled out freely, it is **ELR**.

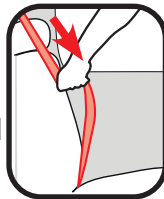

Note: Most vehicles manufactured after 1996 will have Switchable retractors in the back seat. If you have any questions about your retractor type, consult your vehicle owner's manual or call Graco for assistance.

How to Lock Your Lap and Shoulder Vehicle Seat Belt

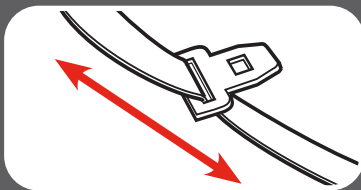

Sliding Latchplate and Switchable Retractor

A latchplate that slides freely on the belt webbing and cannot, by itself, hold the belt snug around a car seat.

When installing the car seat, route the vehicle seat belt through the proper belt path and buckle it in. **Slowly pull the shoulder belt all the way out to switch it to locking mode.** Then, as you pull the vehicle seat belt tight, feed all the slack back into the retractor.

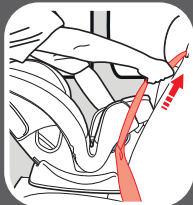
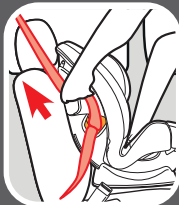

Grab the sides of the seat at the belt path and slide the seat side-to-side and front-to-back. The seat should not move more than 1" (2.5 cm).

Note: With the vehicle seat belt in this locking mode, all the tension is upwards in the shoulder belt. This may start to tilt your car seat sideways. If this happens, use a locking clip instead of this switching the retractor. See Sliding Latchplate and ELR Retractor.

Locking Latchplate and ELR Retractor

A latchplate that holds the lap belt snug after it has been adjusted; contains a metal bar on the underside of the hardware that “locks” the belt in position.

When installing the car seat, route the vehicle seat belt through the proper belt path and buckle it in. Then, pull upwards on the shoulder belt so that the lap belt gets tight around the car seat.

Grab the sides of the seat at the belt path and slide the seat side-to-side and front-to-back. The seat should not move more than 1” (2.5 cm).

Note: When using the SnugLock® lock-off, you do not need to switch the retractor. The SnugLock® lock-off locks the seat belt.

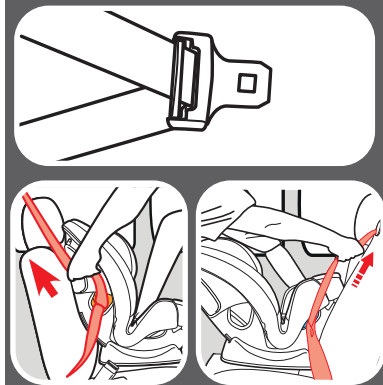

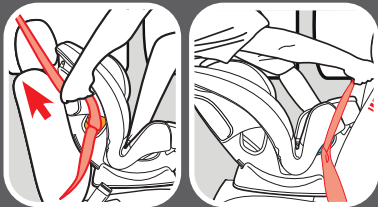
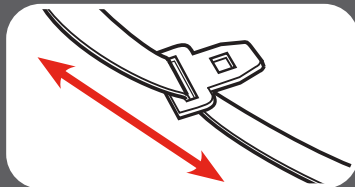

Sliding Latchplate and ALR Retractor

A latchplate that slides freely on the belt webbing and cannot, by itself, hold the belt snug around a car seat.

Slowly pull the shoulder belt all the way out. Route the vehicle seat belt through the proper belt path and buckle it in. Then, as you pull the vehicle seat belt tight, feed all the slack back into the retractor.

Grab the sides of the seat at the belt path and slide the seat side-to-side and front-to-back. The seat should not move more than 1 inch (2.5 cm).

Sliding Latchplate and ELR Retractor

A latchplate that slides freely on the belt webbing and cannot, by itself, hold the belt snug around a car seat.

With this retractor, you will need to use the locking clip to lock the vehicle seat belt.

To get a locking clip order online at gracobaby.com or call 1-800-345-4109

Route the vehicle seat belt through the proper belt path and buckle it in. Pull the vehicle seat belt tight. While pushing down on seat, pinch the two straps together behind the buckle tongue. Unbuckle the belt without allowing it to slip.

Attach locking clip to lap and shoulder belts as shown.

Rebuckle belt. Check that lap belt does not move by pulling hard. If belt loosens or lengthens, repeat procedure.

Note: When using the SnugLock® lock-off, you do not need to use the locking clip. The SnugLock® lock-off locks the seat belt.

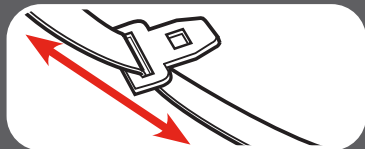

Locking Clip

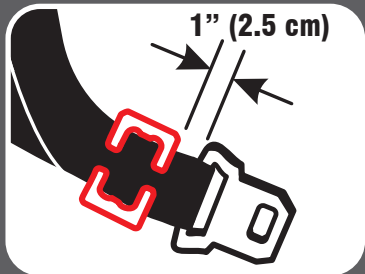

Lap Belt Installation

Always review your vehicle owner's manual for specific information about your vehicle seat belts.



Grab the sides of the seat at the belt path and slide the seat side-to-side and front-to-back. The seat should not move more than 1" (2.5 cm).

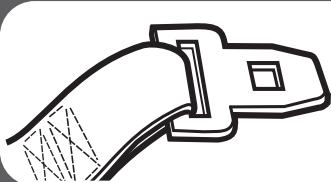

Locking Latchplate and No Retractor

When installing the car seat, route the lap seat belt through the proper path and buckle it in. Then, pull upwards on the tail of the belt so that the lap belt gets tight around the car seat.

Sewn On Latchplate and ALR

Slowly pull the lap belt all the way out. Route the vehicle seat lap belt through the proper belt path and buckle it in. Then, pull the lap belt tight while feeding all the slack back into the retractor.

9-E Aircraft Installation

This child restraint is certified for use in aircraft when using the harness system, and **ONLY** when not using the SnugLock® lock-off.

This child restraint is not certified for aircraft use when used as a booster seat because aircrafts do not have shoulder belts. **NEVER** use a vehicle lap-only belt across front of child.



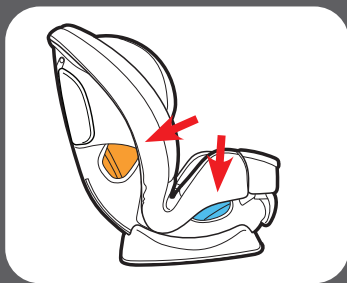

1. **Move the Lower Anchor Attachment**

Rear-Facing: If installing rear-facing, move the lower anchor attachment to the forward-facing belt path marked with an orange label.

Forward-Facing: If installing forward-facing, move the lower anchor attachment to the rear-facing belt path marked with a blue label.

See section 8 to move Lower Anchor attachment.

2. Route the Aircraft Seat Belt Over the SnugLock® Lock-off

Thread the aircraft seat belt through the belt path and out the other side. Buckle it. The seat belt should lie as flat as possible and not be twisted.

Note: It may be easier to route the aircraft seat belt by lifting seat pad up to expose the belt path.

Rear-Facing: Make sure the aircraft seat belt is **(A)** in front of the buckle strap when the buckle is in the inner-most position, and **(B)** in behind when in the outer-most position and that it is flat and is not twisted.

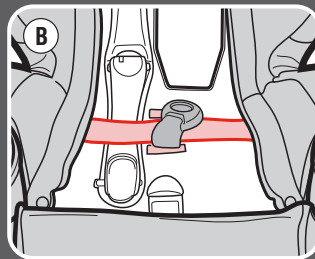
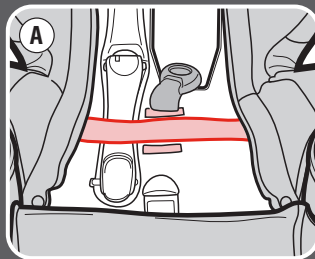

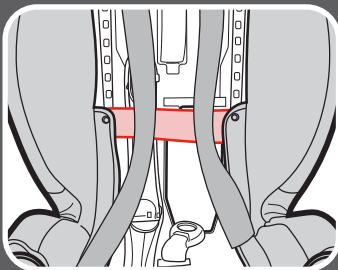

Forward-Facing: Make sure the aircraft seat belt is routed behind the harness strap, is flat, and is not twisted.

For complete rear-facing installation, see section 3-C, and for forward-facing installation, see section 4-C.

10-A Cleaning Seat Pad

Head Support Cover

Raise the headrest to the highest position.

Undo the two snaps below the head support.

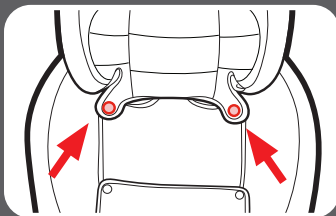
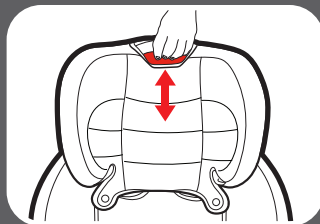

10 Care &
Cleaning

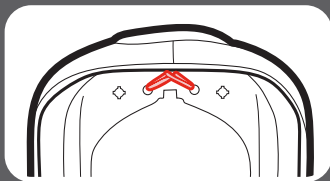

Undo elastic loops behind head support.

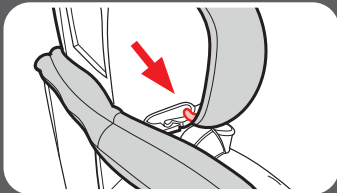

Undo elastic loops inside each shoulder belt guide.

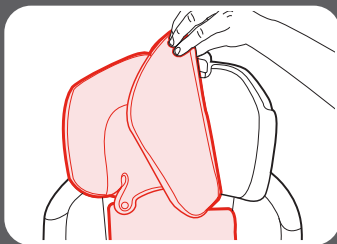

Peel cover off head support.

Machine wash pad in cold water on delicate cycle and drip-dry. **DO NOT USE BLEACH.**

To put the head support cover back on, reverse preceding steps.

Seat Pad

Undo the two snaps.

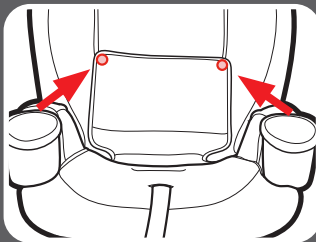

Pull the seat pad forward and undo the 2 snaps at the front of the seat.

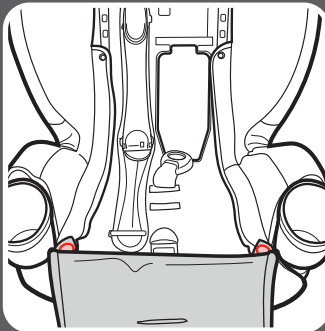

10 Care & Cleaning

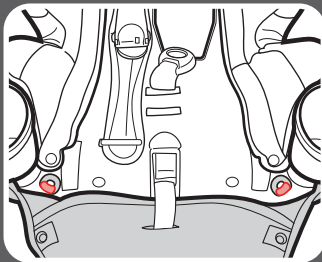

Continue to pull the seat pad forward and under the 2 elastic loops at the front of the seat.

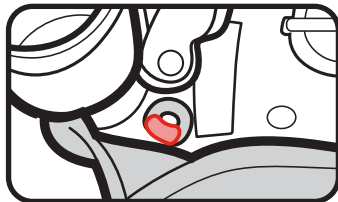

Undo the fabric below each cup holder and remove the seat pad from the shell.

Machine wash pad in cold water on delicate cycle and drip-dry. **DO NOT USE BLEACH.**

To put the seat pad back on, reverse preceding steps.

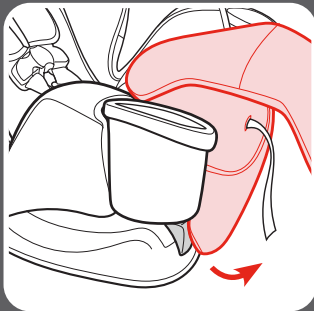

Side Pad

On each side of the seat, undo the snap near the forward-facing belt path and the snap at the front of the seat **(A)**.

Undo the armrest fabric behind each cup holder **(B)**.

Undo the fabric below each lap belt guide **(C)**.

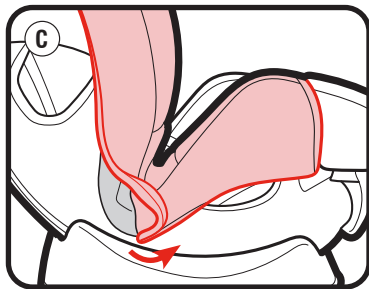
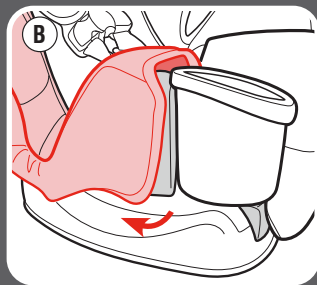
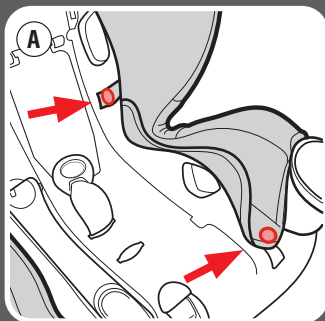

10 Care & Cleaning

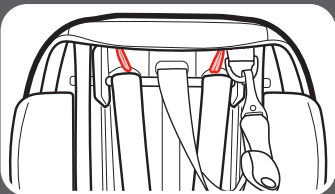

Undo elastic loops on the back of the seat.

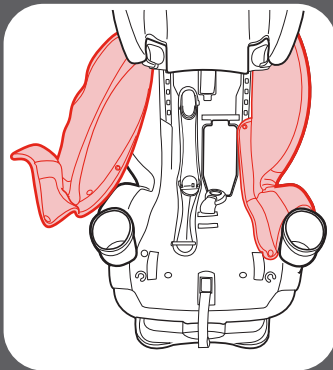

Remove the side pad from the shell.

Machine wash pad in cold water on delicate cycle and drip-dry. **DO NOT USE BLEACH.**

To put the seat pad back on, reverse preceding steps.

10-B Cleaning Crotch Buckle



10 Care &
Cleaning

Recline the car seat and locate the metal retainer. Rotate the metal retainer up through the shell and pad. From the front, pull the crotch buckle out.

To clean buckle, place in a cup of warm water and gently agitate the buckle. Press the red button several times while in the water.

DO NOT SUBMERGE THE BUCKLE STRAP. DO NOT USE SOAPS, HOUSEHOLD DETERGENTS or LUBRICANTS.

Shake out excess water and allow to air dry. Repeat steps as needed until it fastens with a click. Re-insert the buckle into the same slot it was removed. Pull up on crotch buckle to make sure it is secured.

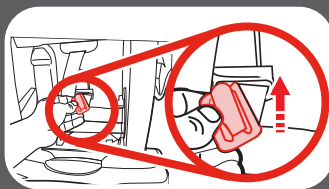

WARNING! Inspect and clean buckle from time to time to remove any objects or debris that could prevent latching.

10-C Cleaning Harness, Lower Anchors and Tether

Surface wash only with mild soap and damp cloth. **DO NOT IMMERSE THE HARNESS STRAPS, LOWER ANCHOR STRAP or TETHER STRAP IN WATER** Doing so may weaken the straps. If harness straps, lower anchor strap or tether strap are frayed or heavily soiled, contact Customer Service at www.gracobaby.com or 1-800-345-4109.

Notes

Replacement Parts

To purchase parts or accessories in the United States, please contact us at the following:

www.gracobaby.com

or

1-800-345-4109

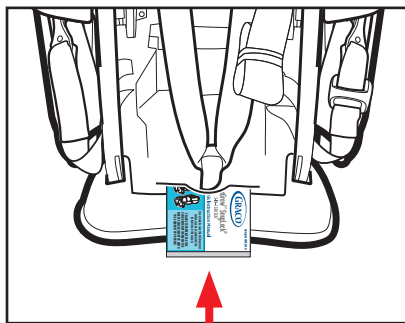

Store instruction manual
in base as shown.