



# bionaire

AIR PURIFIER  
AIR PURIFIER



BAPO041UVVWH/  
BAPO041UVVWH-CN

*Please read this user's manual carefully, and keep it for reference.*

*Please read this user's manual carefully, and keep it for reference.*

P.N. NWL0001345567



# bionaire

Fresh air is here.

It's a new beginning.

A clean way forward.

A fresh start.

Take a deep breath.

A better way to breathe has finally arrived.

## CONTENTS

Safeguards	3
Product features and overview	5
Getting started	7
Operating instructions	7
Care and maintenance	8
How to clean the fabric	8
How to replace the true HEPA filter	9
How to replace the UV light bulb	10
Troubleshooting and support	11
Warranty information	12

## IMPORTANT SAFEGUARDS

When using electrical appliances, basic safety precautions should always be followed to reduce the risk of fire, electric shock, and injury to persons. These precautions include:

### READ ALL INSTRUCTIONS BEFORE USING THIS PRODUCT.

1. Read all instructions before using the appliance.
2. If the filter is covered by a bag when shipped, remove plastic bag before use and keep away from children.
3. Keep the cord out of heavy traffic areas. To avoid fire hazard, never put the cord under rugs, near heat registers, radiators, stoves, or heaters.
4. To protect against electrical hazards, do not immerse the appliance or use near water or other liquids.
5. This appliance is not intended for use by children or by persons with reduced physical, sensory, or mental capabilities, or lack of experience and knowledge. Close supervision is necessary when any appliance is used near children. Children should be supervised to ensure that they do not play with the appliance. Keep the appliance and its cord out of reach of children.
6. Always turn the appliance off before unplugging it.
7. Always unplug the air purifier before moving or cleaning the unit, opening the filter door, changing the filters and whenever the unit is not in use. To disconnect the unit, be sure to pull the plug and not the cord.
8. Never drop or insert any objects into the openings of the unit.
9. Do not operate any appliance with a damaged cord or plug. If the motor fan fails to operate or the unit has been dropped or damaged in any manner, return appliance to manufacturer for examination and/or repair.
10. Use appliance only for intended household use as described in this manual. Any other use not recommended by the manufacturer may cause fire, electric shock, or injury to persons.
11. Do not use outdoors.
12. Never place on a soft surface such as a bed or sofa as this could cause the unit to tip over and block the air inlet or outlet grills.

13. Keep unit away from heated surfaces and open flames.
14. Do not place anything on top of unit.
15. Never use detergents, gasoline, glass cleaner, furniture polish, paint thinner or other household solvents to clean any part of the appliance.
16. This appliance should only be used in a room with temperatures between 50° F and 104° F.
17. **WARNING:** To reduce the risk of fire or electric shock, do not use this appliance with any solid-state speed control device.
18. Do not place the appliance on a walkway or where someone may trip over it. Misplacement of the appliance may cause a trip and fall.
19. **CAUTION:** DISCONNECT POWER FROM ASSEMBLY BEFORE SERVICING OR REPLACING UV LAMP.
20. **WARNING:** THIS COVER IS PROVIDED WITH AN INTERLOCK TO REDUCE THE RISK OF EXPOSURE TO EXCESSIVE ULTRAVIOLET RADIATION. DO NOT DEFEAT ITS PURPOSE. DO NOT ATTEMPT TO SERVICE WITHOUT REMOVING COVER COMPLETELY.
21. This product complies with the maximum allowable concentration of ozone of 0.050 parts per million by volume (ppmv) in a 24-h period.
22. The ionizer in this appliance produces less ozone than the UL established limits of 50ppb (parts per billion). However, in high concentrations, ozone can be harmful to birds and small pets. To prevent ozone buildup, we suggest using the ionizer in well ventilated areas with the fan on.
23. **WARNING:** Skin or eye damage may result from directly viewing the light produced by the lamp in this apparatus. Always disconnect power before relamping or servicing. Replace Lamp With Lamp BAP004I, Manufactured by Sunbeam Products, Inc. Maximum 3.5 Watts.
24. **CAUTION:** Only use the power adaptor that is provided with the unit. Do not use other power adaptors.
25. The ionizer may cause a static charge to build up on the air outlet grill. A static charge may be felt if the unit is not properly grounded. To avoid a static charge, plug the unit's three-prong plug into a grounded outlet. The static charge will not occur if the ionizer is off.





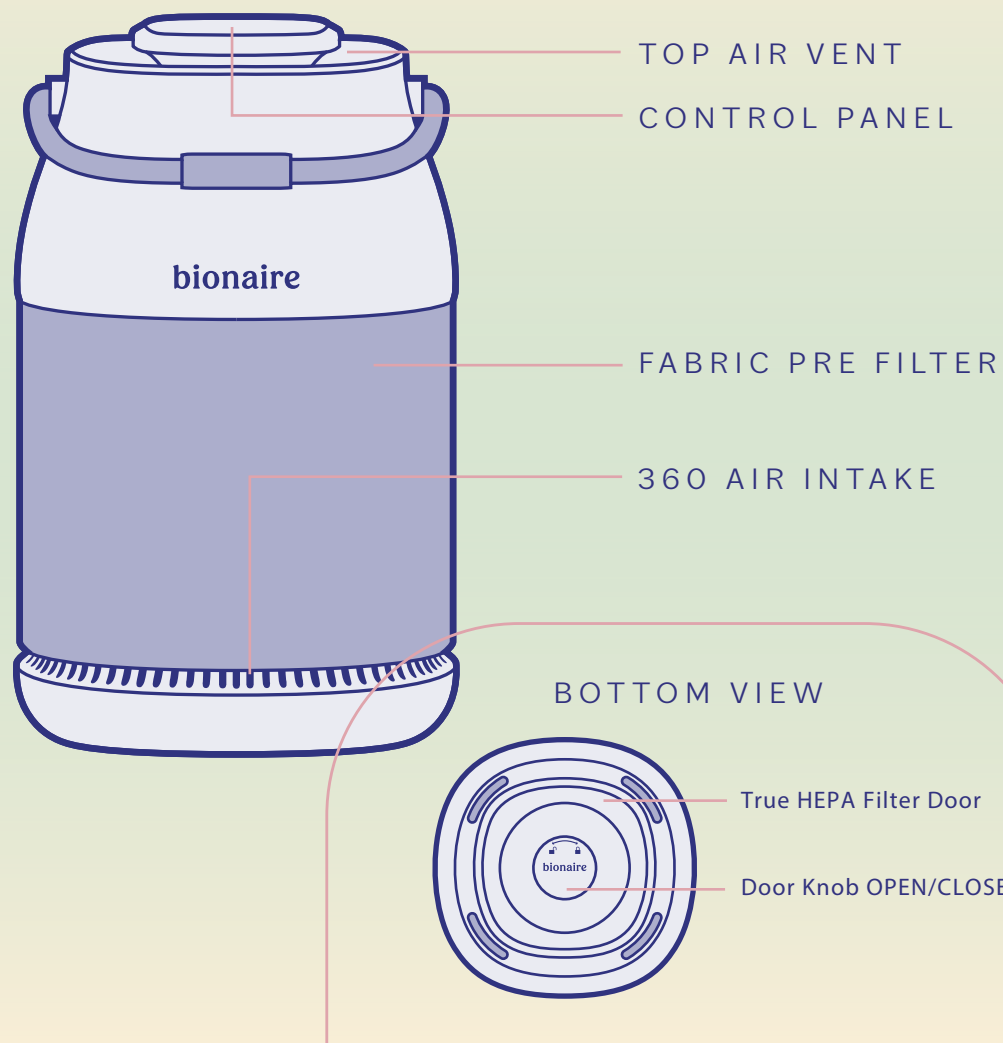

## SAVE THESE INSTRUCTIONS

HOUSEHOLD USE ONLY

## GET TO KNOW YOUR AIR PURIFIER



## CONTROL PANEL & FEATURES

-  **ON/OFF BUTTON**  
Turns unit on or off.
-  **FAN SPEED SETTINGS**  
I (low)  
II (medium)  
III (high)
-  **UV LIGHT PROTECT™**  
Turns the UV light on and off depending on your preference.
-  **IONIZER**  
Turns the ionizer on and off depending on your preference.
-  **TIMER**  
Sets a timer for 4, 8 or 12 hours.
-  **NIGHTLIGHT**  
Turns the night light on and off.

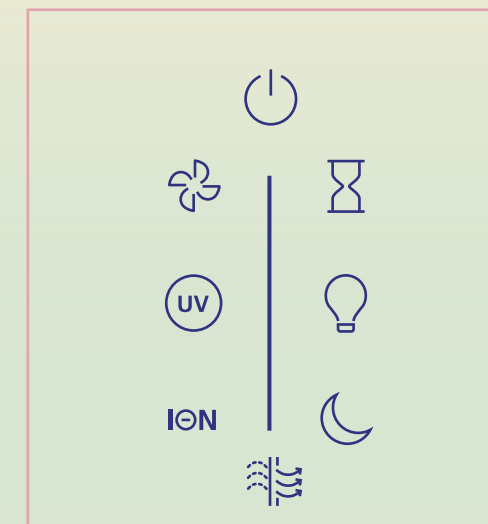

-  **NIGHT MODE**  
Dims the display lights so you can sleep comfortably.
-  **FILTER REPLACEMENT INDICATOR**  
Illuminates in red when it's time to replace your filter.

## PRODUCT SPECIFICATIONS

CADR	Smoke: 113cfm	Noise Level on High Speed	59dB(A) max
Fan Speeds	3	Power Consumption	38W

## ENERGY® STAR CERTIFICATION





This product earned the ENERGY STAR label by meeting strict energy efficiency guidelines set by the U.S. EPA. Room air cleaners have demonstrated the potential for improving air quality and providing health benefits. EPA does not endorse manufacturer claims regarding the degree to which a specific product will produce healthier indoor air. The energy efficiency of this ENERGY STAR certified model is measured based on a ratio between the model's CADR for Smoke and the electrical energy it consumes, or CADR/Watt.

## GETTING STARTED

1. Locate the filter door on the bottom of the unit. Rotate the knob counterclockwise to expose the filter.
2. Remove the plastic bag from the filter and re-insert the filter.
3. Realign the filter door and gently thread the knob clockwise to close.
4. Your unit is equipped with one True HEPA filter that last 8-12 months.

## OPERATING INSTRUCTIONS

1. Place the unit on a dry, stable and firm surface. Make sure not to block the top air vent and air intake grille.
2. Connect the power adaptor to the power jack located on the rear base of the unit. Plug the adaptor into a 120V AC electrical outlet.  
CAUTION: Only use the power adaptor that is provided with the unit. Do not use other power adaptors.
3. Press the power button (  ) to turn the unit ON
4. Select desired fan speed setting I (low), II (medium), III (high) by pressing the fan button to cycle through the speeds until it reaches desired speed setting.
5. To turn the ionizer ON, press the ION button once until the white LED light next to the button is illuminated. Press the ION button again to turn the ionizer OFF.

6. To turn UV ON, press the UV button once until the white LED light next to the button is illuminated. Press the UV button again to turn the UV OFF.
7. To turn Night Mode ON, press the (  ) button once until the white LED light next to the button is illuminated. Press the (  ) button again Night Mode OFF.
8. To turn the Night Light ON, press the (  ) button. To turn the Night Light OFF, press the (  ) button once more.
9. Important: Always turn off and unplug the unit when not in use.

## CARE AND MAINTENANCE

- Before cleaning the air purifier, turn OFF and unplug the unit.
- Clean the exterior surface with a clean, damp cloth.
- The top air vent can be cleaned of dust with a small, soft brush.
- If you would like to clean the inside of the filter compartment, ONLY use a dry, soft cloth to wipe it down.

**WARNING:** Do not allow moisture to come into contact with the main housing of the air purifier. NEVER use detergents, gasoline, glass cleaner, furniture polish, paint thinner, or other household solvents to clean any part of the appliance.

## HOW TO CLEAN THE FABRIC

It is recommended to clean the fabric every 3 months or when dust appears.

1. Turn the unit OFF and unplug.
2. Gently vacuum the dust from the fabric or wipe clean with a damp cloth.

## HOW TO REPLACE THE HEPA FILTER

It is recommended to replace the True HEPA filter every 8-12 months.

1. The Filter Replacement Indicator light (filter icon) starts blinking when it is time to replace the filter.
2. Turn the unit OFF and unplug the air purifier.

### 3.

Locate the filter door on the bottom of the unit and gently unthread the knob counterclockwise to open.

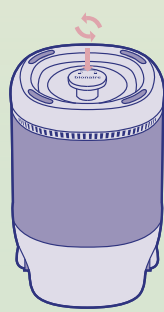

### 4.

Remove the filter and discard. Insert a new Bionaire True Hepa filter (model# BAPF36I).

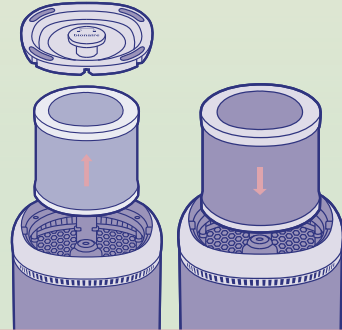

### 5.

Realign the filter door and gently thread the knob clockwise to close.

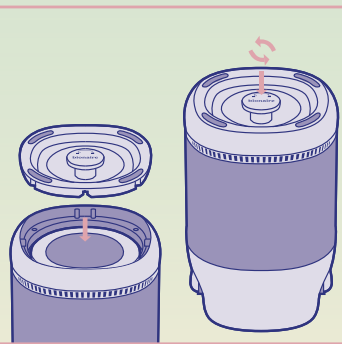

6. Plug the unit and turn the power ON.
7. To reset the filter status, press & hold the filter button for 3 seconds.

## HOW TO REPLACE THE UV LIGHT BULB

It is recommended to replace the UV light bulb every 12 months.

Turn the unit OFF and unplug the air purifier.

To replace:

### 1.

Locate the filter door on the bottom of the unit and gently unthread the knob counterclockwise to open.

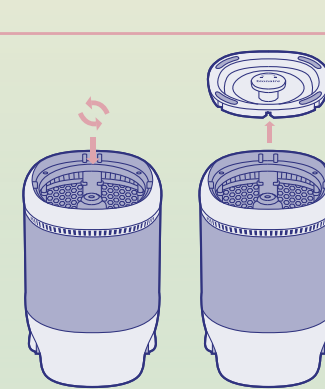

### 2.

Remove the filter and set aside.

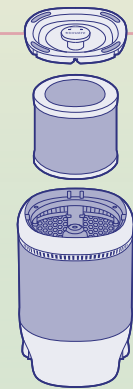

### 3.

Carefully remove the UV bulb housing by using a screwdriver to remove the four screws.

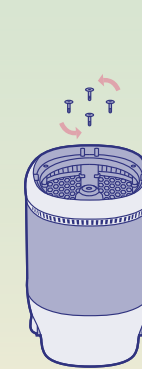

### 4.

Carefully remove the UV bulb by rotating the bulb counterclockwise. Discard the old UV bulb.

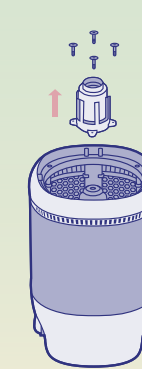

### 5.

Install the new UV bulb by rotating the bulb clockwise.

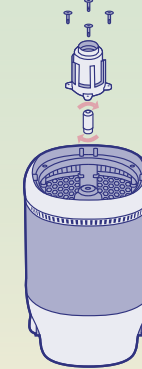

6. Carefully reinstall the UV bulb housing by using a screwdriver to secure the four screws.
7. Reinsert the filter.
8. Realign the filter door and gently thread the knob clockwise to close.

## TROUBLESHOOTING

PROBLEM	SOLUTION
Why is my unit not working?	<ul style="list-style-type: none"> <li>✓ Check if unit is properly plugged in and outlet is working.</li> <li>✓ Make sure unit is turned ON.</li> <li>✓ Make sure filter is properly installed and the filter door is correctly closed.</li> <li>✓ Make sure to use the adaptor that is supplied with the air purifier, do not use other adaptors.</li> </ul>
Why is there a decrease in air flow?	<ul style="list-style-type: none"> <li>✓ Make sure nothing is blocking air intake grille and filtered air outlet.</li> <li>✓ Check condition of the filter and replace if necessary.</li> <li>✓ Check filter to remove any plastic wrapping/packaging.</li> </ul>
Why is the unit making a loud noise?	<ul style="list-style-type: none"> <li>✓ Make sure parts are firmly positioned in place.</li> <li>✓ Open the filter door and verify that any plastic packaging was removed from the filter</li> </ul>

## FCC COMPLIANT DECLARATION OF CONFORMITY

BIONAIRE BAP0041UVVWH/BAP0041UVVWH-CN  
Distributed by Sunbeam Products, Inc.  
2381 NW Executive Center Dr. Boca Raton, FL 33431  
Visit our Website at: <http://www.bionaire.com>  
Bionaire® Brand Customer Service - United States: 1-800-253-2764

This product complies with part 15 of the FCC Rules. Operation is subject to the following two conditions: (1) This product may not cause harmful interference, and (2) this product must accept any interference received, including interference that may cause undesired operation.

Note: This product has been tested and found to comply with the limits for a Class B digital device, pursuant to part 15 of the FCC Rules. These limits are designed to provide reasonable protection against harmful interference in a residential installation. This product generates, uses and can radiate radio frequency energy and, if not installed and used in accordance with the instructions, may cause harmful interference to radio communications. However, there is no guarantee that interference will not occur in a particular installation. If this product does cause harmful interference to radio or television reception, which can be determined by turning the product off and on, the user is encouraged to try to correct the interference by one or more of the following measures:

- Reorient or relocate the receiving antenna.
- Increase the separation between the product and receiver.
- Connect the product into an outlet on a circuit different from that to which the receiver is connected.
- Consult the dealer or an experienced radio/TV technician for help.

Changes or modifications not expressly approved by the party responsible for compliance could void the user's authority to operate the equipment.

### ICES STATEMENT

This apparatus meets all requirements of the Canadian Interference-Causing Equipment Regulations. This Class B digital apparatus complies with Canadian ICES-003.

## WARRANTY INFORMATION

### 1 YEAR LIMITED WARRANTY

Sunbeam Products, Inc. or if in Canada Newell Brands Canada ULC (collectively, "Sunbeam"), warrants that for a period of one year from the date of initial retail purchase, this product will be free from defects in material and workmanship, when used in accordance with the instructions provided. Sunbeam, at its option, will repair or replace this product or any component of the product found to be defective during the warranty period. Replacement will be made with a new or remanufactured product or component. If the product is no longer available, replacement may be made with a similar product of equal or greater value. This is your exclusive warranty. Do NOT attempt to repair or adjust any electrical or mechanical functions on this product. Doing so will void this warranty. This warranty is valid for the original retail purchaser from the date of initial retail purchase and is not transferable.

Keep the original sales receipt. Proof of purchase is required to obtain warranty performance. Sunbeam dealers, service centers, or retail stores selling Sunbeam products do not have the right to alter, modify or any way change the terms and conditions of this warranty. This warranty does not cover normal wear of parts or damage resulting from any of the following: negligent use or misuse of the product, use on improper voltage or current, use contrary to the operating instructions, disassembly, repair or alteration by anyone other than Sunbeam or an authorized Sunbeam service center. Further, the warranty does not cover: Acts of God, such as fire, flood, hurricanes and tornadoes.

### WHAT ARE THE LIMITS ON SUNBEAM'S LIABILITY?

Sunbeam shall not be liable for any incidental or consequential damages caused by the breach of any express, implied or statutory warranty or condition. Except to the extent prohibited by applicable law, any implied warranty or condition of merchantability or fitness for a particular purpose is limited in duration to the duration of the above warranty.

Sunbeam disclaims all other warranties, conditions or representations, express, implied, statutory or otherwise. Sunbeam shall not be liable for any damages of any kind resulting from the purchase, use or misuse of, or inability to use the product including incidental, special, consequential or similar damages or loss of profits, or for any breach of contract, fundamental or otherwise, or for any claim brought against purchaser by any other party. Some provinces, states or jurisdictions do not allow the exclusion or limitation of incidental or consequential damages or limitations on how long an implied warranty lasts, so the above limitations or exclusion may not apply to you. This warranty gives you specific legal rights, and you may also have other rights that vary from province to province, state to state or jurisdiction to jurisdiction.

### HOW TO OBTAIN WARRANTY SERVICE

#### In the U.S.A.

If you have any questions regarding this warranty or would like to obtain warranty service, please call 1-800-253-2764 and a convenient service center address will be provided to you.

#### In Canada

If you have any questions regarding this warranty or would like to obtain warranty service, please call 1-800-253-2764 and a convenient service center address will be provided to you.

In the U.S.A., this warranty is offered by Sunbeam Products, Inc. Boca Raton, Florida 33431. In Canada, this warranty is offered by Newell Brand Canada ULC located at 20B Hereford Street, Brampton, Ontario L6Y 0M1. If you have any other problem or claim in connection with this product, please write to Consumer Service Department.

**PLEASE DO NOT RETURN THIS PRODUCT TO ANY OF THESE ADDRESSES OR TO THE PLACE OF PURCHASE.**

© 2021 Sunbeam Products, Inc. All rights reserved. Distributed by Sunbeam Products, Inc. Boca Raton, Florida 33431.

Printed In China



# bionaire

Fresh air is here.

It's a new beginning.

A clean way forward.

A fresh start.

Take a deep breath.

A better way to breathe has finally arrived.

## CONTENTS

Safeguards	15
Product features and overview	17
Getting started	19
Operating instructions	19
Care and maintenance	20
How to clean the fabric	20
How to replace the true HEPA filter	21
How to replace the UV light bulb	22
Troubleshooting and support	23
Warranty information	24



## IMPORTANT SAFEGUARDS

When using electrical appliances, basic safety precautions should always be followed to reduce the risk of fire, electric shock, and injury to persons. These precautions include:

### READ ALL INSTRUCTIONS BEFORE USING THIS PRODUCT.

- I. Read all instructions before using the appliance.
2. If the filter is covered by a bag when shipped, remove plastic bag before use and keep away from children.
3. Keep the cord out of heavy traffic areas. To avoid fire hazard, never put the cord under rugs, near heat registers, radiators, stoves, or heaters.
4. To protect against electrical hazards, do not immerse the appliance or use near water or other liquids.
5. This appliance is not intended for use by children or by persons with reduced physical, sensory, or mental capabilities, or lack of experience and knowledge. Close supervision is necessary when any appliance is used near children. Children should be supervised to ensure that they do not play with the appliance. Keep the appliance and its cord out of reach of children.
6. Always turn the appliance off before unplugging it.
7. Always unplug the air purifier before moving or cleaning the unit, opening the filter door, changing the filters and whenever the unit is not in use. To disconnect the unit, be sure to pull the plug and not the cord.
8. Never drop or insert any objects into the openings of the unit.
9. Do not operate any appliance with a damaged cord or plug. If the motor fan fails to operate or the unit has been dropped or damaged in any manner, return appliance to manufacturer for examination and/or repair.
10. Use appliance only for intended household use as described in this manual. Any other use not recommended by the manufacturer may cause fire, electric shock, or injury to persons.
- II. Do not use outdoors.
12. Never place on a soft surface such as a bed or sofa as this could cause the unit to tip over and block the air inlet or outlet grills.

13. Keep unit away from heated surfaces and open flames.
14. Do not place anything on top of unit.
15. Never use detergents, gasoline, glass cleaner, furniture polish, paint thinner or other household solvents to clean any part of the appliance.
16. This appliance should only be used in a room with temperatures between 50° F and 104° F.
17. **WARNING:** To reduce the risk of fire or electric shock, do not use this appliance with any solid-state speed control device.
18. Do not place the appliance on a walkway or where someone may trip over it. Misplacement of the appliance may cause a trip and fall.
19. **ATTENTION : COUPER L'ALIMENTATION DE L'ASSEMBLAGE AVANT DE PROCÉDER AU DÉPANNAGE OU REMPLACEMENT DU LAMPE UV.**
20. **AVERTISSEMENT : CE COUVERCLE EST MUNI D'UN SYSTÈME DE VERROUILLAGE PERMETTANT DE RÉDUIRE LES RISQUES D'EXPOSITION AU L'EXCÈS DE RAYONS ULTRAVIOLETS. NE PAS NUIRE À L'ACTION DU VERROUILLAGE. NE TENTEZ PAS DE RÉPARER SANS ENLEVER LE COUVERCLE.**
21. This product complies with the maximum allowable concentration of ozone of 0.050 parts per million by volume (ppmv) in a 24-h period.
22. The ionizer in this appliance produces less ozone than the UL established limits of 50ppb (parts per billion). However, in high concentrations, ozone can be harmful to birds and small pets. To prevent ozone buildup, we suggest using the ionizer in well ventilated areas with the fan on.
23. **WARNING:** Skin or eye damage may result from directly viewing the light produced by the lamp in this apparatus. Always disconnect power before relamping or servicing. Replace Lamp With Lamp BAP004I, Manufactured by Sunbeam Products, Inc. Maximum 3.5 Watts.
24. **CAUTION:** Only use the power adaptor that is provided with the unit. Do not use other power adaptors.
25. The ionizer may cause a static charge to build up on the air outlet grill. A static charge may be felt if the unit is not properly grounded. To avoid a static charge, plug the unit's three-prong plug into a grounded outlet. The static charge will not occur if the ionizer is off.





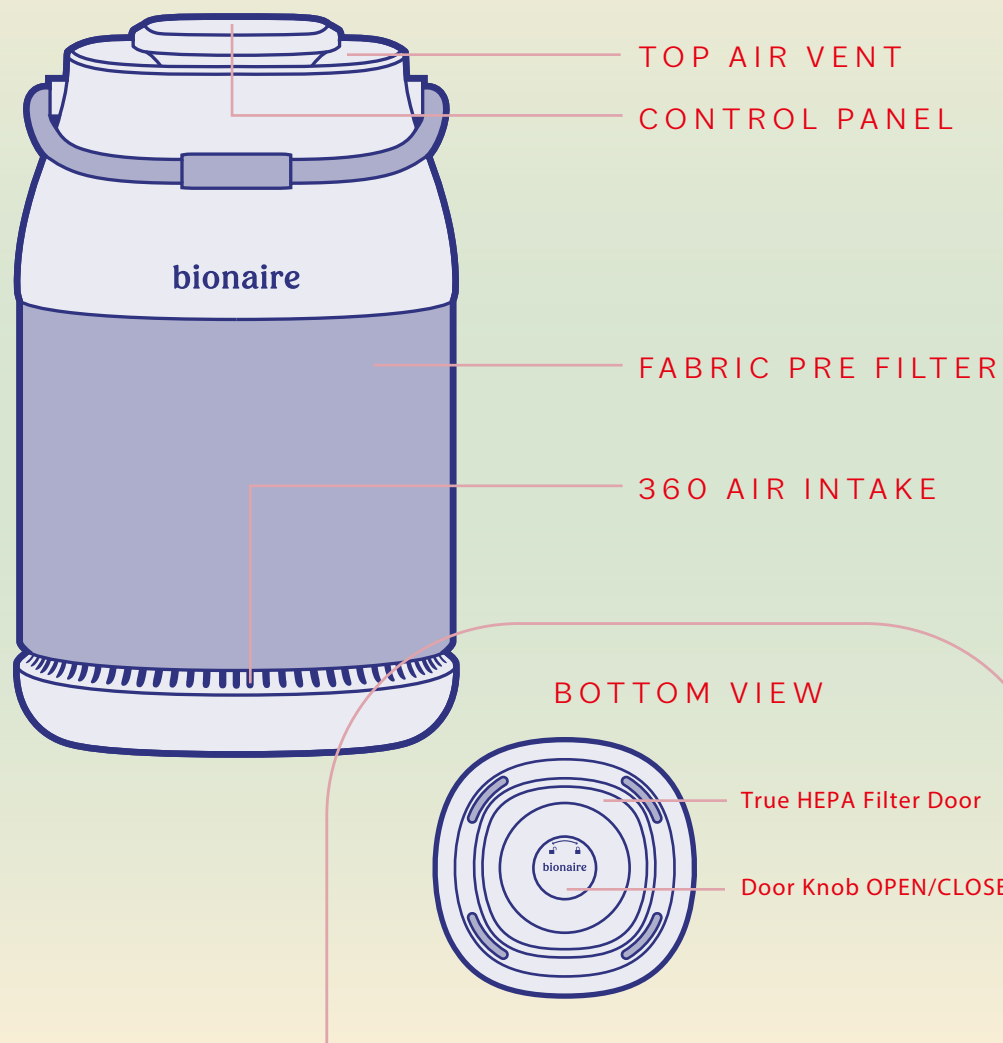

## SAVE THESE INSTRUCTIONS

HOUSEHOLD USE ONLY

## GET TO KNOW YOUR AIR PURIFIER



## CONTROL PANEL & FEATURES

-  **ON/OFF BUTTON**  
Turns unit on or off.
-  **FAN SPEED SETTINGS**  
I (low)  
II (medium)  
III (high)
-  **UV LIGHT PROTECT™**  
Turns the UV light on and off depending on your preference.
-  **IONIZER**  
Turns the ionizer on and off depending on your preference.
-  **TIMER**  
Sets a timer for 4, 8 or 12 hours.
-  **NIGHTLIGHT**  
Turns the night light on and off.

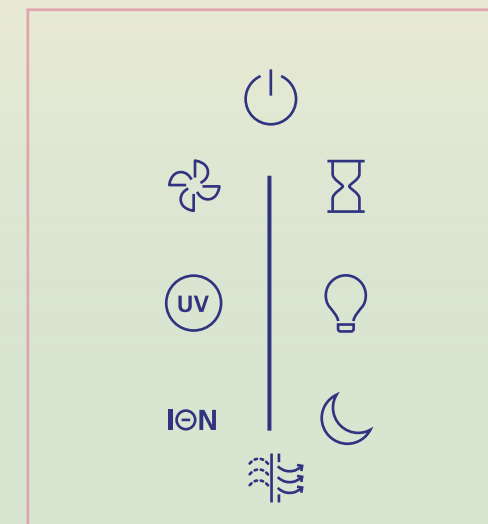

-  **NIGHT MODE**  
Dims the display lights so you can sleep comfortably.
-  **FILTER REPLACEMENT INDICATOR**  
Illuminates in red when it's time to replace your filter.

## PRODUCT SPECIFICATIONS

CADR	Smoke: 113cfm	Noise Level on High Speed	59dB(A) max
Fan Speeds	3	Power Consumption	38W

## ENERGY® STAR CERTIFICATION





This product earned the ENERGY STAR label by meeting strict energy efficiency guidelines set by the U.S. EPA. Room air cleaners have demonstrated the potential for improving air quality and providing health benefits. EPA does not endorse manufacturer claims regarding the degree to which a specific product will produce healthier indoor air. The energy efficiency of this ENERGY STAR certified model is measured based on a ratio between the model's CADR for Smoke and the electrical energy it consumes, or CADR/Watt.

## GETTING STARTED

1. Locate the filter door on the bottom of the unit. Rotate the knob counterclockwise to expose the filter.
2. Remove the plastic bag from the filter and re-insert the filter.
3. Realign the filter door and gently thread the knob clockwise to close.
4. Your unit is equipped with one True HEPA filter that last 8-12 months.

## OPERATING INSTRUCTIONS

1. Place the unit on a dry, stable and firm surface. Make sure not to block the top air vent and air intake grille.
2. Connect the power adaptor to the power jack located on the rear base of the unit. Plug the adaptor into a 120V AC electrical outlet.  
CAUTION: Only use the power adaptor that is provided with the unit. Do not use other power adaptors.
3. Press the power button (  ) to turn the unit ON
4. Select desired fan speed setting I (low), II (medium), III (high) by pressing the fan button to cycle through the speeds until it reaches desired speed setting.
5. To turn the ionizer ON, press the ION button once until the white LED light next to the button is illuminated. Press the ION button again to turn the ionizer OFF.

6. To turn UV ON, press the UV button once until the white LED light next to the button is illuminated. Press the UV button again to turn the UV OFF.
7. To turn Night Mode ON, press the (  ) button once until the white LED light next to the button is illuminated. Press the (  ) button again Night Mode OFF.
8. To turn the Night Light ON, press the (  ) button. To turn the Night Light OFF, press the (  ) button once more.
9. Important: Always turn off and unplug the unit when not in use.

## CARE AND MAINTENANCE

- Before cleaning the air purifier, turn OFF and unplug the unit.
- Clean the exterior surface with a clean, damp cloth.
- The top air vent can be cleaned of dust with a small, soft brush.
- If you would like to clean the inside of the filter compartment, ONLY use a dry, soft cloth to wipe it down.

**WARNING:** Do not allow moisture to come into contact with the main housing of the air purifier. NEVER use detergents, gasoline, glass cleaner, furniture polish, paint thinner, or other household solvents to clean any part of the appliance.

## HOW TO CLEAN THE FABRIC

It is recommended to clean the fabric every 3 months or when dust appears.

1. Turn the unit OFF and unplug.
2. Gently vacuum the dust from the fabric or wipe clean with a damp cloth.

## HOW TO REPLACE THE HEPA FILTER

It is recommended to replace the True HEPA filter every 8-12 months.

1. The Filter Replacement Indicator light (filter icon) starts blinking when it is time to replace the filter.
2. Turn the unit OFF and unplug the air purifier.

### 3.

Locate the filter door on the bottom of the unit and gently unthread the knob counterclockwise to open.

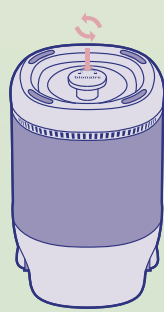

### 4.

Remove the filter and discard. Insert a new Bionaire True Hepa filter (model# BAPF36I).

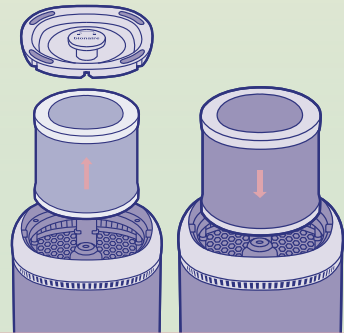

### 5.

Realign the filter door and gently thread the knob clockwise to close.

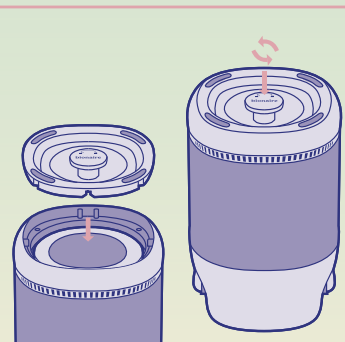

6. Plug the unit and turn the power ON.
7. To reset the filter status, press & hold the filter button for 3 seconds.

## HOW TO REPLACE THE UV LIGHT BULB

It is recommended to replace the UV light bulb every 12 months.

Turn the unit OFF and unplug the air purifier.

To replace:

### 1.

Locate the filter door on the bottom of the unit and gently unthread the knob counterclockwise to open

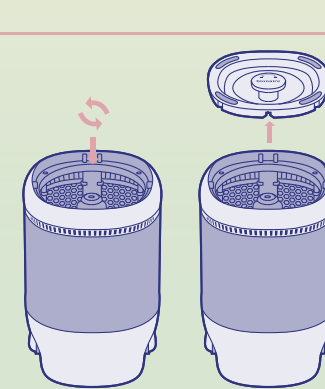

### 2.

Remove the filter and set aside.

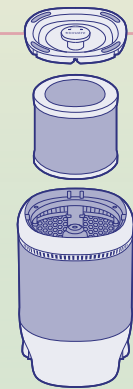

### 3.

Carefully remove the UV bulb housing by using a screwdriver to remove the four screws.

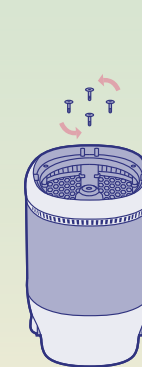

### 4.

Carefully remove the UV bulb by rotating the bulb counterclockwise. Discard the old UV bulb.

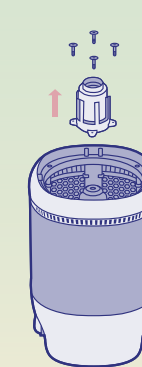

### 5.

Install the new UV bulb by rotating the bulb clockwise.

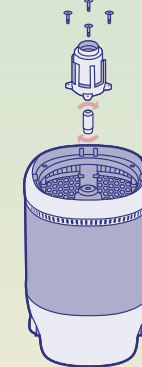

6. Carefully reinstall the UV bulb housing by using a screwdriver to secure the four screws.
7. Reinsert the filter.
8. Realign the filter door and gently thread the knob clockwise to close.

## TROUBLESHOOTING

PROBLEM	SOLUTION
Why is my unit not working?	<ul style="list-style-type: none"> <li>✓ Check if unit is properly plugged in and outlet is working.</li> <li>✓ Make sure unit is turned ON.</li> <li>✓ Make sure filter is properly installed and the filter door is correctly closed.</li> <li>✓ Make sure to use the adaptor that is supplied with the air purifier, do not use other adaptors.</li> </ul>
Why is there a decrease in air flow?	<ul style="list-style-type: none"> <li>✓ Make sure nothing is blocking air intake grille and filtered air outlet.</li> <li>✓ Check condition of the filter and replace if necessary.</li> <li>✓ Check filter to remove any plastic wrapping/packaging.</li> </ul>
Why is the unit making a loud noise?	<ul style="list-style-type: none"> <li>✓ Make sure parts are firmly positioned in place.</li> <li>✓ Open the filter door and verify that any plastic packaging was removed from the filter</li> </ul>

## FCC COMPLIANT

### DECLARATION OF CONFORMITY

BIONAIRE BAP0041UVVH/BAP0041UVVH-CN  
 Distributed by Sunbeam Products, Inc.  
 2381 NW Executive Center Dr. Boca Raton, FL 33431  
 Visit our Website at: <http://www.bionaire.com>  
 Bionaire® Brand Customer Service - United States: 1-800-253-2764

This product complies with part 15 of the FCC Rules. Operation is subject to the following two conditions: (1) This product may not cause harmful interference, and (2) this product must accept any interference received, including interference that may cause undesired operation.

Note: This product has been tested and found to comply with the limits for a Class B digital device, pursuant to part 15 of the FCC Rules. These limits are designed to provide reasonable protection against harmful interference in a residential installation. This product generates, uses and can radiate radio frequency energy and, if not installed and used in accordance with the instructions, may cause harmful interference to radio communications. However, there is no guarantee that interference will not occur in a particular installation. If this product does cause harmful interference to radio or television reception, which can be determined by turning the product off and on, the user is encouraged to try to correct the interference by one or more of the following measures:

- Reorient or relocate the receiving antenna.
- Increase the separation between the product and receiver.
- Connect the product into an outlet on a circuit different from that to which the receiver is connected.
- Consult the dealer or an experienced radio/TV technician for help.

Changes or modifications not expressly approved by the party responsible for compliance could void the user's authority to operate the equipment.

### AVIS DE LA NMB

Cet appareil répond aux exigences du Règlement sur le matériel brouilleur du Canada. Cet appareil numérique de classe B est conforme à la norme NMB-003 du Canada.

## WARRANTY INFORMATION

### 1 YEAR LIMITED WARRANTY

Sunbeam Products, Inc. or if in Canada Newell Brands Canada ULC (collectively, "Sunbeam"), warrants that for a period of one year from the date of initial retail purchase, this product will be free from defects in material and workmanship, when used in accordance with the instructions provided. Sunbeam, at its option, will repair or replace this product or any component of the product found to be defective during the warranty period. Replacement will be made with a new or remanufactured product or component. If the product is no longer available, replacement may be made with a similar product of equal or greater value. This is your exclusive warranty. Do NOT attempt to repair or adjust any electrical or mechanical functions on this product. Doing so will void this warranty. This warranty is valid for the original retail purchaser from the date of initial retail purchase and is not transferable. Keep the original sales receipt. Proof of purchase is required to obtain warranty performance. Sunbeam dealers, service centers, or retail stores selling Sunbeam products do not have the right to alter, modify or any way change the terms and conditions of this warranty. This warranty does not cover normal wear of parts or damage resulting from any of the following: negligent use or misuse of the product, use on improper voltage or current, use contrary to the operating instructions, disassembly, repair or alteration by anyone other than Sunbeam or an authorized Sunbeam service center. Further, the warranty does not cover: Acts of God, such as fire, flood, hurricanes and tornadoes.

### WHAT ARE THE LIMITS ON SUNBEAM'S LIABILITY?

Sunbeam shall not be liable for any incidental or consequential damages caused by the breach of any express, implied or statutory warranty or condition. Except to the extent prohibited by applicable law, any implied warranty or condition of merchantability or fitness for a particular purpose is limited in duration to the duration of the above warranty. Sunbeam disclaims all other warranties, conditions or representations, express, implied, statutory or otherwise. Sunbeam shall not be liable for any damages of any kind resulting from the purchase, use or misuse of, or inability to use the product including incidental, special, consequential or similar damages or loss of profits, or for any breach of contract, fundamental or otherwise, or for any claim brought against purchaser by any other party. Some provinces, states or jurisdictions do not allow the exclusion or limitation of incidental or consequential damages or limitations on how long an implied warranty lasts, so the above limitations or exclusion may not apply to you. This warranty gives you specific legal rights, and you may also have other rights that vary from province to province, state to state or jurisdiction to jurisdiction.

### HOW TO OBTAIN WARRANTY SERVICE

#### In the U.S.A.

If you have any questions regarding this warranty or would like to obtain warranty service, please call 1-800-253-2764 and a convenient service center address will be provided to you.

#### In Canada

If you have any questions regarding this warranty or would like to obtain warranty service, please call 1-800-253-2764 and a convenient service center address will be provided to you.

In the U.S.A., this warranty is offered by Sunbeam Products, Inc. Boca Raton, Florida 33431. In Canada, this warranty is offered by Newell Brand Canada ULC located at 20B Hereford Street, Brampton, Ontario L6Y 0M1. If you have any other problem or claim in connection with this product, please write to Consumer Service Department.

**PLEASE DO NOT RETURN THIS PRODUCT TO ANY OF THESE ADDRESSES OR TO THE PLACE OF PURCHASE.**

© 2021 Sunbeam Products, Inc. All rights reserved. Distributed by Sunbeam Products, Inc. Boca Raton, Florida 33431.

Printed In China

# bionaire

## SUPPORT

At Bonaire we are committed to providing everyday solutions to make our customers' lives easier. If you have any questions or concerns about your product, please let us know.

You can visit us at: [www.bonaire.com](http://www.bonaire.com)

Call us at: 1-800-253-2764

## SUPPORT

At Bonaire we are committed to providing everyday solutions to make our customers' lives easier. If you have any questions or concerns about your product, please let us know.

You can visit us at: [www.bonaire.com](http://www.bonaire.com)

Call us at: 1-800-253-2764