

NWL0001743700C 4/25

GRACO[®]
premier

www.gracobaby.com

4EVER[®] DLX EXTEND2FIT[®] SNUGLOCK[®]

4-IN-1 CAR SEAT

featuring Anti-Rebound Bar

Read This Instruction Manual

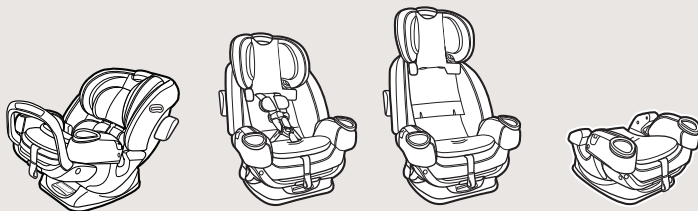

Do not install or use this child restraint until you read and understand the instructions in this manual.

FAILURE TO PROPERLY USE THIS CHILD RESTRAINT INCREASES THE RISK OF SERIOUS INJURY OR DEATH IN A SUDDEN STOP OR CRASH.



**Scan the code or visit
www.gracobaby.com to view
installation videos.**

1 Important

Pages 5-13

- 1-A Welcome to the Graco Family**
- 1-B Safety Warnings**
- 1-C Right Mode of Use**
- 1-D Aircraft Installation**

2 Features

Pages 14-21

3 Rear-Facing

Pages 22-38

- 3-A Rear-Facing Use**
- 3-B Install Rear-Facing with Lower Anchor Attachment**
- 3-C Install Rear-Facing with Vehicle Seat Belt**

4 Forward-Facing

Pages 39-53

- 4-A Forward-Facing Use**
- 4-B Install Forward-Facing with LATCH**
- 4-C Install Forward-Facing with the Vehicle Seat Belt**

5 Securing Child

Pages 54-62

5-A Securing Child 5-Point Harness

6 Booster

Pages 63-90

6-A Booster Use

6-B Install Highback Booster

6-C Install Backless Booster

6-D Securing Child Highback Booster

6-E Securing Child Backless Booster

7 Moving the Lower Anchor Attachment

Pages 91-95

8 Accessories

Pages 96-97

9 Anti-Rebound Bar

Pages 98-99

10 Vehicle Information

Pages 100-106

10-A How to Uninstall Lower Anchor Connectors and Tether

10-B Which Installation Method Should I use?

10-C Choosing Vehicle Seat Location

10-D Unsafe Vehicle Seat Location

10-E Vehicle Seat Belts

11 Care & Cleaning

Pages 107-114

11-A Cleaning Seat Insert

11-B Cleaning Rapid Remove Seat Pad

11-C Cleaning Buckle

11-D Cleaning Harness, Lower Anchor Attachment and Tether

11-E Cleaning Extend2Fit® Extension Panel

11-F Cleaning Anti-Rebound Bar

1-A Welcome to the Graco Family!

Your child's safety depends on you. **No car seat can guarantee protection from injury in every situation, but proper use helps reduce the risk of serious injury or death. READ THIS MANUAL CAREFULLY.**

This child restraint system conforms to all applicable Federal motor vehicle safety standards.

Even if this car seat seems easy to figure out on your own, you must follow the detailed instructions in this instruction manual to ensure the steps are performed correctly.

If You Need Help

In the U.S.A, please contact our Customer Service Department with any questions you may have concerning parts, use, or maintenance. When you contact us, please have your product's model number and date of manufacture ready so that we may help you efficiently. These numbers can be found on a sticker on the back side of your car seat.

Contact us at **www.gracobaby.com or call 1-800-345-4109.**

For additional resources or to get your car seat checked by a child passenger safety technician, please visit the following web sites:

www.nhtsa.gov • www.seatcheck.org • www.safekids.org



1
Important



1 Important

This car seat is for children: *Rear-Facing: 4-50 lb (1.8-22.5 kg)*
Forward-Facing: 26.5-65 lb (12-30 kg)
Backed Booster: 40-100 lb (18.1-45 kg)
Backless Booster: 40-120 lb (18.1-54 kg)

- Children less than 26.5 lb (12 kg) **MUST** use this car seat rear-facing. Review section 1-C for more information.

Note: Preterm or low birth weight infants may be at special risk in a vehicle or aircraft. According to the AAP, these infants may suffer breathing issues if improperly reclined in a car seat. When rear-facing, use the corrected age for premies. Graco advises that you have your physician or hospital staff evaluate your infant and recommend the proper car seat or car bed before you and your infant leave the hospital.

You Must Install Cup Holders (Adult Assembly Required)

Cup holders MUST be installed.

To attach the cup holders, unsnap the seat pad from the side and match the right cup holder to the right side of the seat and the left to the left. Line up the T-slot and side-tab and slide down. **You will hear a “CLICK” when they are secured in place.**

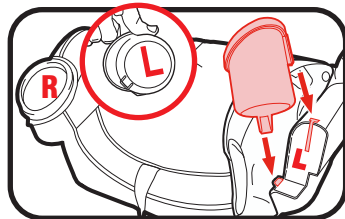

Register This Child Restraint

Please fill out the prepaid registration postcard attached to the harness and mail it in today **or register online at www.gracobaby.com/carseatregistration.**

Child restraints could be recalled for safety reasons. You must register this restraint to be reached in a recall. Send your name, address, and the restraint's model number and manufacturing date to:

Graco Children's Products, Inc.
Attn: Customer Service
P.O. Box 169, Elverson, PA 19520-9901
or call 1-800-345-4109 **or register online at**
www.gracobaby.com/carseatregistration

For recall information, call the U.S. Government's Vehicle Safety Hotline at 1-888-327-4236 (TTY: 1-800-424-9153), or go to <http://www.NHTSA.gov>.

For future reference or if you change addresses, record the model name, model number, date of manufacture and purchase date of this car seat on the below. You can find this information either on the registration card if you still have it or on the date label located on the back of the car seat.

Model Name _____
Model Number _____
Date of Manufacture _____
Date of Purchase _____



1 Important

1-B Safety Warnings

! WARNING!

Failure to follow these instructions and child restraint's labels can result in child striking the vehicle's interior during a sudden stop or crash

! According to accident statistics, children are safer when properly restrained in the rear seating positions than in the front seating positions. The center of the back seat can be the safest during a possible side impact.



! NEVER place this child restraint rear-facing in a vehicle seating location that has an active front air bag.

If an air bag inflates, it can hit the child and car seat with great force and cause serious injury or death to your child.

! Review your vehicle owner's manual for more information about air bags and car seat use.

! Secure car seat with a vehicle seat belt or lower anchor attachment that is properly routed as shown in this manual.



! Always secure car seat with lower anchor attachment or a vehicle seat belt, even when unoccupied. In a crash, an unsecured car seat can injure passengers.

! If car seat is in a crash, it must be replaced. DO NOT use it again! A crash can cause unseen damage and using it again could result in serious injury or death.

! DO NOT use car seat if it is damaged or missing parts.

! DO NOT use accessories or parts other than those provided by Graco except for a thin towel or mat to protect your vehicle seat or rolled towels or pool noodles to help get your car seat level. Their use could alter the performance of the car seat.

! DO NOT remove LATCH system from car seat. If using vehicle seat belt to secure car seat, lower anchor connectors must be stored.

! Never leave child unattended, even when sleeping. Child may become tangled in harness straps and suffocate or strangle.



! Never attach two lower anchor connectors to one vehicle lower anchor point unless specifically allowed by the vehicle manufacturer.



1 Important



1 Important

- ! Do not use both the vehicle seat belt and lower anchor attachment at the same time when using the car seat with the 5-point harness.**
- ! Choose the correct mode of use for the car seat depending on your child's size. Infants less than 26.5 lb (12 kg) **MUST** use this car seat rear-facing.**
- ! Children are safer riding rear-facing and should ride rear-facing as long as possible, until they reach the maximum rear-facing height or weight rating for their car seat. Then children should ride forward-facing, using the built-in harness system for as long as possible until they reach the maximum forward-facing weight or height for their car seat. At that point, children should ride in a belt-positioning booster seat. A booster is no longer needed once the vehicle seat belt fits properly, typically when they reach 4 feet 9 inches (145 cm) tall and are between ages 8-12. Be sure to check your local and state laws, as well as AAP and NHTSA recommendations, for car seat usage.***

*Graco Supports the American Academy of Pediatrics and National Highway Traffic Safety Administration's Car Seat Guidelines. Visit www.gracobaby.com/en-US/safety for information on car seat usage recommendations.

Car Seat's Useful Life

STOP using this car seat and throw it away 10 years after the date of manufacture. Look for this sticker on back of the car seat.

Graco Children's Products Inc. advises against loaning or passing along a car seat unless you know the complete history of the product. We also advise against purchasing a car seat second hand.

Warm Weather Use

Car seat parts can get very hot in the sun or warm weather. **To avoid burns, always check before putting child in car seat.**



1 Important



1 Important

1-C Right Mode of Use

4 lb (1.8 kg)	26.5 lb (12 kg)	40 lb (18.1 kg)	50 lb (22.5 kg)	65 lb (30 kg)	120 lb (54 kg)
------------------	--------------------	--------------------	--------------------	------------------	-------------------

Rear-Facing with 5-Point Harness

Must be 49" (125 cm) or less:
4-26.5 lb (1.8-12 kg) less than 1
year old **MUST** be rear-facing.
26.5-50 lb (12-22.5 kg) **SHOULD**
be rear-facing.*

Forward-Facing with 5-Point Harness

Must be 49" (125 cm) or less:
26.5-50 lb (12-22.5 kg) can sit upright
unassisted **CAN** be forward-facing.
50-65 lb (22.5-30 kg) **SHOULD** be
forward-facing.*

Booster Mode with Vehicle Lap/Shoulder Seat Belt

Must be 43-57" (110.1-145 cm) tall and 4+ years old:
40-65 lb (18.1-30 kg) **CAN** be in backed booster mode.
40-65 lb (18.1-30 kg) **CAN** be in backless booster mode.
Over 65 lb (30 kg) **MUST** be in booster mode.*

*Check your local and state laws and the AAP/NHTSA recommendations. See page 10 for more information.

1-D Aircraft Installation



This car seat is certified for use in aircraft when using the harness system and **without** using the lockoff. Use only on forward-facing aircraft seats. Review section 3-C and section 4-C. Do not use the tether.



This car seat is NOT certified for use in aircraft when using the lockoff OR when used as a booster seat because aircrafts do not have shoulder belts.

Contact the airline for their specific policies.

When installing the car seat, route the lap seat belt through the proper path and buckle it in. Then, pull on the tail of the belt so that the lap belt gets tight around the car seat.

Grab the sides of the seat at the belt path where the lap belt is and move the car seat from side-to-side and front-to-back. If it moves less than 1" (2.5 cm), it is tight enough.

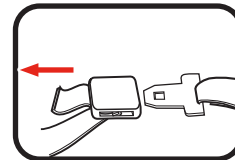
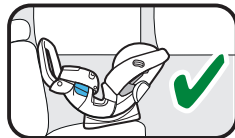

1 Important

2-A Car Seat Features



2 Features

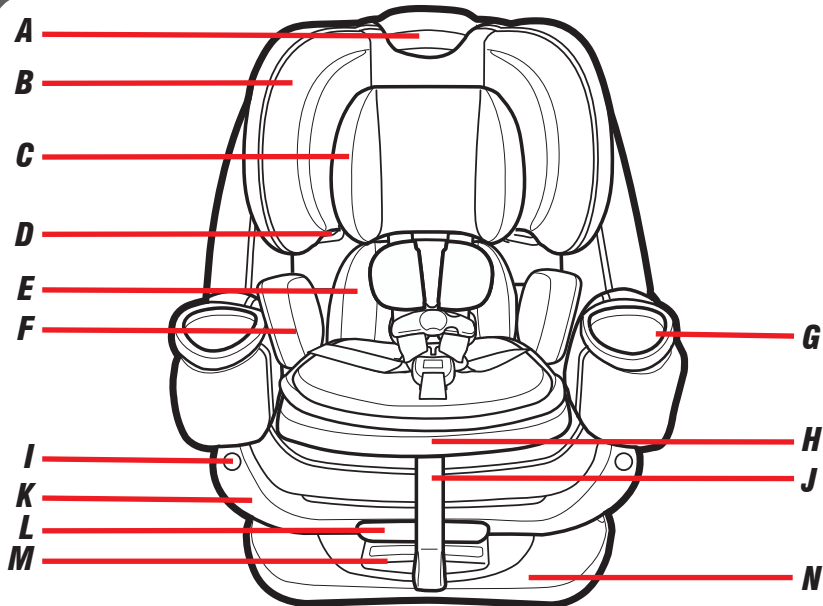

- A Headrest/Harness Height Adjustment Lever**
- B Headrest**
- C Infant Head Support**
- D Booster Shoulder Belt Guide**
- E Infant Body Support**
- F Seat Insert**
- G Cup Holder (Must Be Installed)**
- H Harness Adjustment Lever**
(under pad)
- I Anti-Rebound Bar Slots**
- J Harness Adjustment Strap**
- K Extension Panel**
- L Extension Handle**
- M Recline Handle**
- N Seat Base**
- O Harness Covers**
- P Chest Clip**
- Q Harness Straps**
- R Buckle**
- S Buckle Strap**

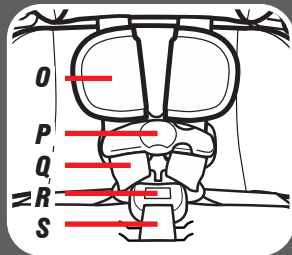

2 Features



2 Features

With Seat Pads Removed:

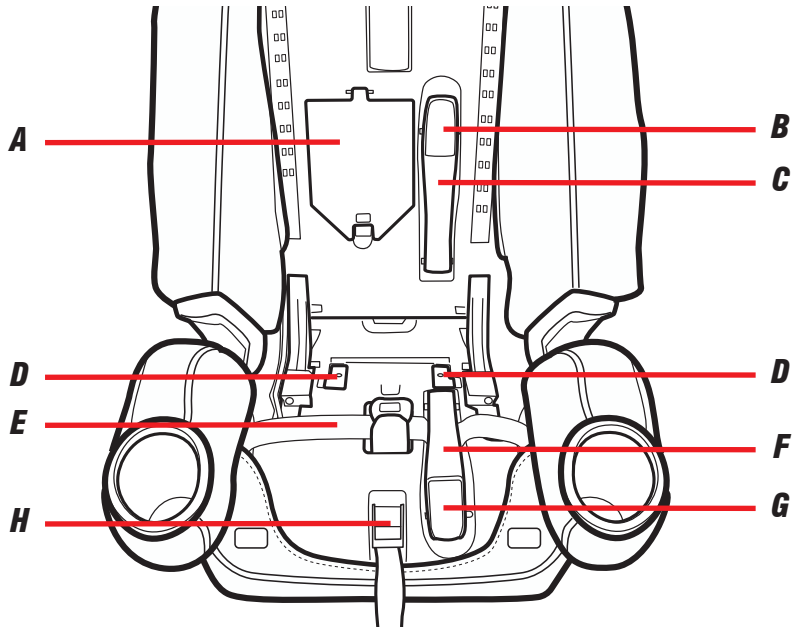

- A Harness Storage Compartment***
- B Forward-Facing SnugLock® Lock-Off Release Button***
- C Forward-Facing SnugLock® Lock-Off***
- D Backrest Locks***
- E Lower Anchor Strap***
- F Rear-Facing SnugLock® Lock-Off***
- G Rear-Facing SnugLock® Lock-Off Release Button***
- H Harness Adjustment Lever***



2 Features



2 Features

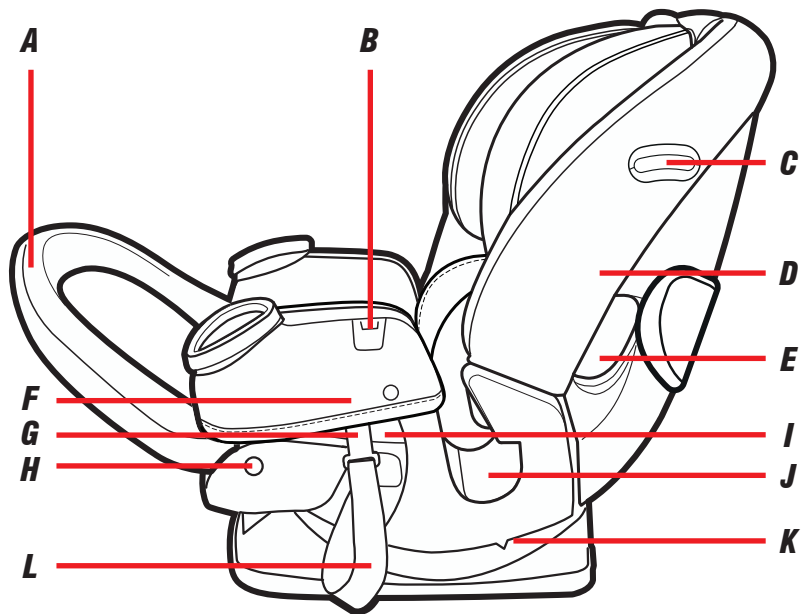

- A Anti-Rebound Bar**
- B Buckle Tongue Fuss Free Harness Storage**
- C Level Indicator**
- D Forward-Facing Lower Anchor Connector Storage**
- E Forward-Facing Belt Path**
- F Rear-Facing Lower Anchor Connector Storage** *(under armrest)*
- G Lower Anchor Connector**
- H Anti-Rebound Bar Release Button**
- I Rear-Facing Belt Path**
- J Booster Lap Belt Path**
- K Recline Position Indicator**
- L Lower Anchor Strap**



2 Features



2 Features

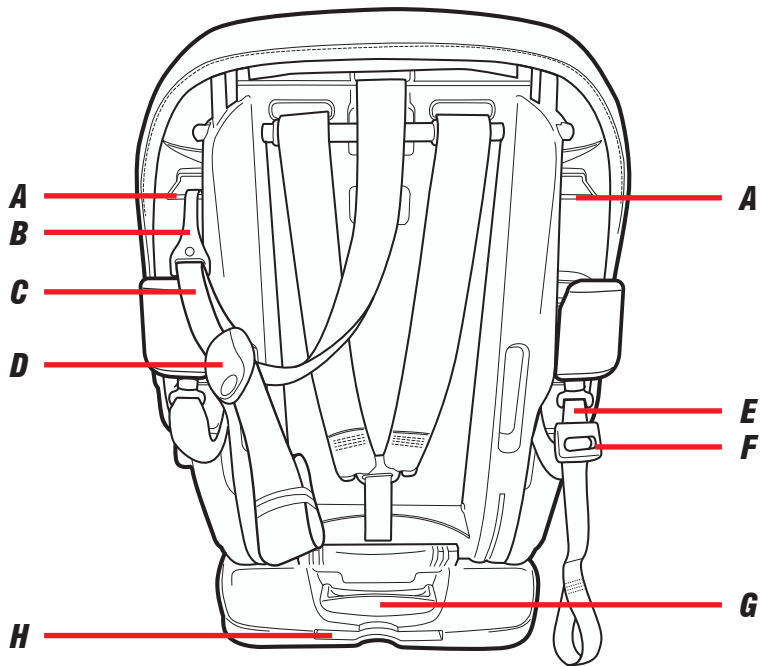

- A Tether Storage Bar**
- B Tether Hook**
- C Tether Strap**
- D Tether Strap Adjuster**
- E Lower Anchor Strap**
- F Lower Anchor Adjuster**
- G Recline Handle**
- H Instruction Manual Storage**
- I Shoulder Belt Positioning Clip**

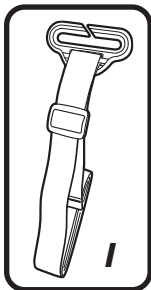

3-A Rear-Facing Use

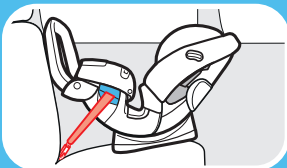

Lower Anchor Attachment

Do not install by this method for a child weighing more than 35 lb (16 kg)

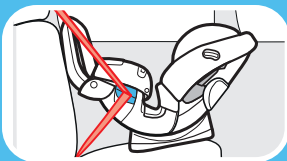

Vehicle Seat Lap/Shoulder Belt

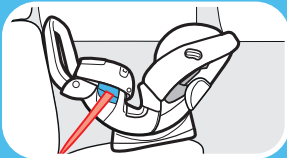

Vehicle Seat Lap Belt

**Rear-Facing:
4-50 lb (1.8-22.5 kg) and 49"
(125 cm) or less in height**

- Infants who weigh less than 26.5 lb (12 kg) **MUST be rear-facing.**
- Children are safer riding rear-facing and should ride rear-facing as long as possible, until they reach the maximum rear-facing height or weight rating for their car seat. Then children should ride forward-facing, using the built-in harness system for as long as possible until they reach the maximum forward-facing weight or height for their car seat. Be sure to check your local and state laws, as well as AAP and NHTSA recommendations, for car seat usage.

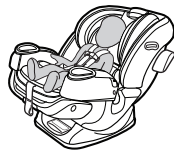

WARNING! NEVER place this child restraint rear-facing in a vehicle seating location that has an active front air bag.

3-B Install Rear-Facing with Lower Anchor Attachment

Review your vehicle's owner manual for lower anchor location and use. Do not install by this method for a child weighing more than 35 lb (16 kg).

1. Store Tether

Attach tether hook to the plastic bar on either side of the car seat.

2. Attach Anti-Rebound Bar (Optional)

Insert the ends of the Anti-Rebound Bar into the holes on the front of the seat until the bar clicks into place.

The Anti-Rebound Bar can **ONLY** be used in rear-facing mode.

3. Remove Lower Anchor Connectors from Storage Location

Push in on the red buttons on the lower anchor connectors and remove from storage position.

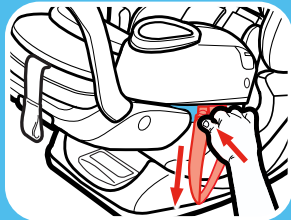
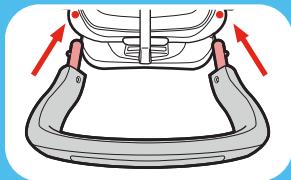
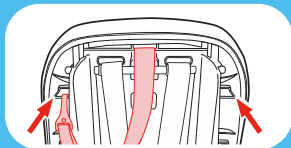

3-B
Rear Facing
with Lower Anchor
Attachment

3-B Rear Facing with Lower Anchor Attachment

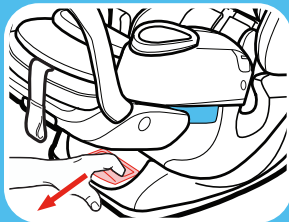
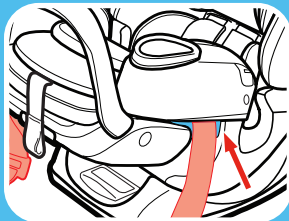

4. **Make Sure the Lower Anchor Strap is in the Rear-Facing Belt Path Marked With a Blue Label**

To move the lower anchor attachment, review section 7.

5. **Recline the Car Seat**

Place the car seat in 1st, 2nd, 3rd or 4th recline position.

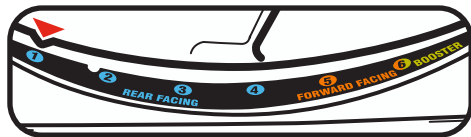

6. **To Keep Your Child Rear Facing Longer**

For additional legroom, squeeze the extension handle and pull the extension panel out. The extension panel has 4 positions.

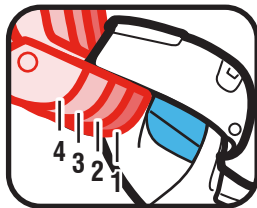

7. Place Car Seat Rear-Facing in Back Seat of the Vehicle

Place rear-facing in vehicle seat and center the car seat between the lower anchors. The base should sit as flat as possible on the vehicle seat.

8. Make Sure Base is a minimum of 80% on Vehicle Seat.

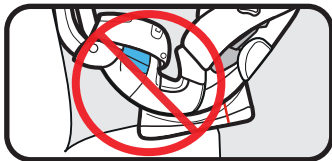

9. Check the Level Indicator

Vehicle **MUST** be on level ground.

Check the level indicator on the car seat. The **bubble must be completely within** the blue zone.

Adjust the recline until the bubble is completely within the blue zone.

If needed, rolled towels may be placed under the car seat at the vehicle seat crease, until the ball is completely in the blue zone.

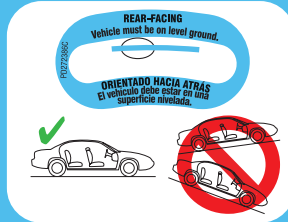
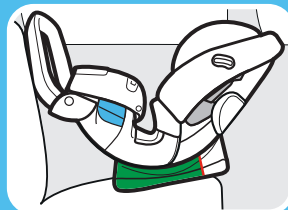
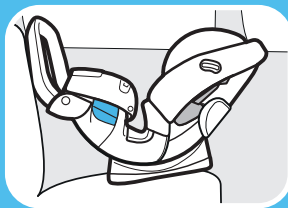

3-B

Rear Facing
with Lower Anchor
Attachment

3-B
Rear Facing
with Lower Anchor
Attachment

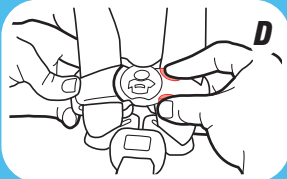
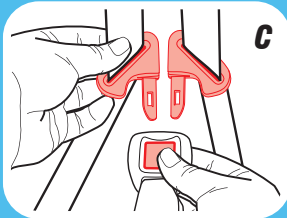
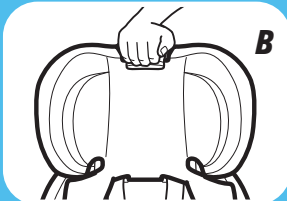
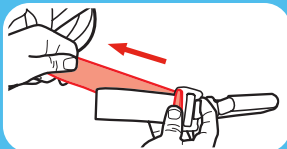

10. Extend the Lower Anchor Strap

For easier installation, extend the lower anchor strap to its maximum length by pressing the grey button and pulling on the strap.

Using With the Belt Lock-Off:

11. Expose the Belt Lock-Off

- A.** Loosen the harness straps.
- B.** Raise the headrest to the highest position.
- C.** Unbuckle the buckle.
- D.** Unbuckle the chest clip.

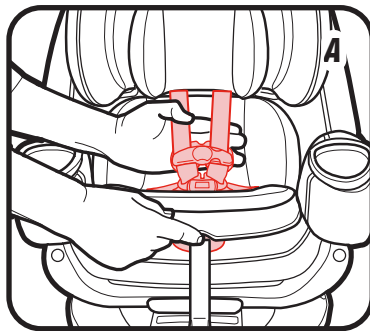

E. Lift Bottom Seat Pad Up to expose the plastic shell

12. Open the SnugLock® Lock-Off

Lift the lever to open the SnugLock® lock-off.

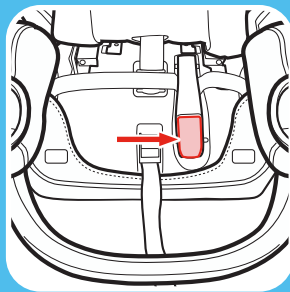
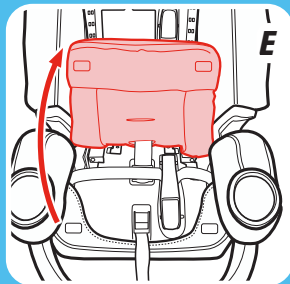

3-B

**Rear Facing
with Lower Anchor
Attachment**

3-B
Rear Facing
with Lower Anchor
Attachment

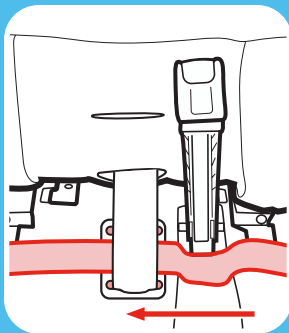
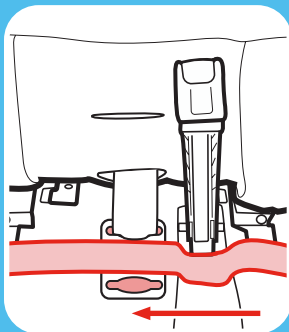

13. Make Sure the Lower Anchor strap is Routed Under the SnugLock® Lock-Off

The lower anchor strap should lie as flat as possible and not be twisted.

Make sure the lower anchor strap is in front of the buckle strap when the buckle is in the inner-most position, and behind when in the outer-most position.

14. Connect the Lower Anchor Connectors to Vehicle's Lower Anchors

Make sure the arrows are pointing up. Lower anchor strap should not be twisted. If twisted, you will not be able to tighten the strap.

Lower anchor connectors can only be used if the vehicle lower anchor spacing is 11 inches (28 cm) from the center of one lower anchor to the center of the other lower anchor.

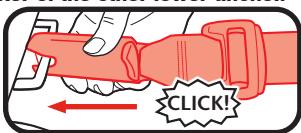

15. Tighten the Lower Anchor Strap

Press down firmly in the center of the car seat while tightening the lower anchor strap.

You may need to tighten the lower anchor strap through the rear-facing belt path to get a tight fit. Do not pull on the strap with excessive force.

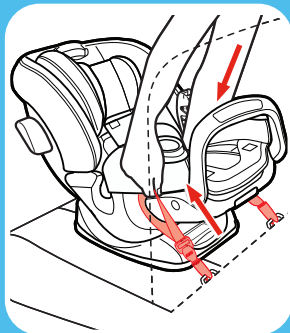
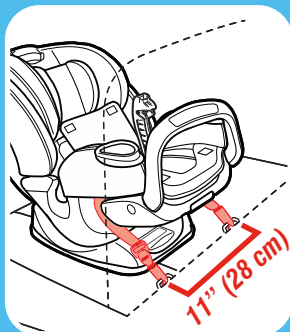
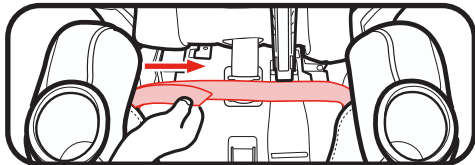

3-B
Rear Facing
with Lower Anchor
Attachment

3-B
Rear Facing
with Lower Anchor
Attachment

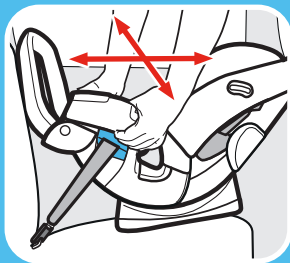
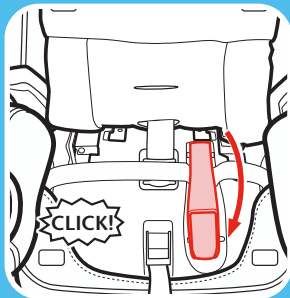

16. Close the SnugLock® Lock-Off

When the slack is removed, close the SnugLock® Lock-Off until you hear a “Click”. Make sure the Lower Anchor strap is under the SnugLock® Lock-Off.

WARNING! Keep hands away from the lock-off area when closing the lock-off.

17. Test For Tightness

Grab the sides of the seat where the lower anchor strap is and slide the car seat side-to-side and front-to-back.

If the seat moves less than 1” (2.5 cm), it is tight enough.

18. Replace the Seat Pad

Move the headrest back to its proper position for your child.

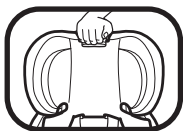

19. Check the Level Indicator

Vehicle **MUST** be on level ground.

Check the level indicator on the car seat. The **bubble must be completely within** the blue zone. Readjust if needed.

See section 5-A to secure your child.

Recheck the level indicator with child in seat.

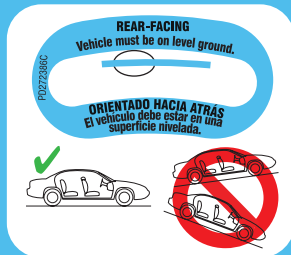
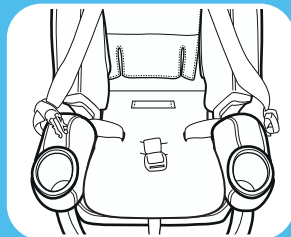

3-B

Rear Facing
with Lower Anchor
Attachment

3-C Install Rear-Facing with Vehicle Seat Belt



1. **Make Sure the Lower Anchor Strap is in the Forward-Facing Belt Path Marked with Orange Label**

To move the lower anchor attachment, review section 7.

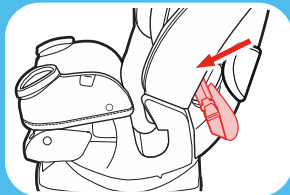

2. **Store Tether and Lower Anchor Connectors in Storage Locations**

Attach tether hook and lower anchor connectors to the plastic bars as shown.

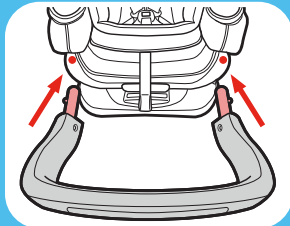
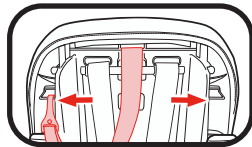

3. **Attach Anti-Rebound Bar (Optional)**

Insert the ends of the Anti-Rebound Bar into the holes on the front of the seat until the bar clicks into place.

The Anti-Rebound Bar can **ONLY** be used in rear-facing mode.

4. Recline the Car Seat

Place the car seat in 1st, 2nd, 3rd or 4th recline position.

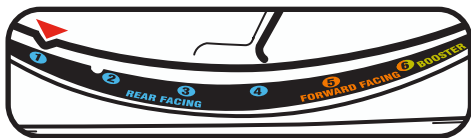

5. To Keep Your Child Rear Facing Longer

For additional legroom, squeeze the extension handle and pull the extension panel out. The extension panel has 4 positions.



6. Place Car Seat Rear-Facing in Back Seat of the Vehicle

Place rear-facing in vehicle seat. The base should sit as flat as possible on the vehicle seat.

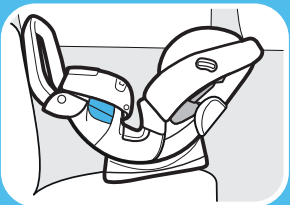
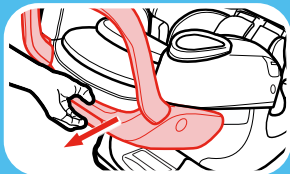
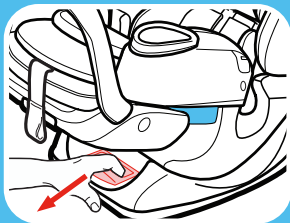

3-C
Rear Facing
with Seat Belt

3-C Rear Facing with Seat Belt

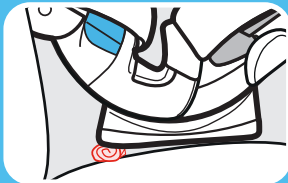
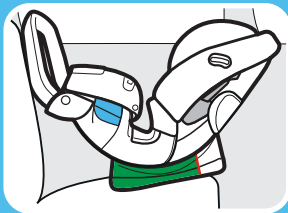

7. Make Sure Base is a minimum of 80% on Vehicle Seat.



8. Check the Level Indicator

Vehicle **MUST** be on level ground.

Check the level indicator on the car seat. The **bubble must be completely within** the blue zone.

Adjust the recline until the bubble is completely within the blue zone.

If needed, rolled towels may be placed under the car seat at the vehicle seat crease, until the ball is completely in the blue zone.

Using With the Belt Lock-Off:

9. Expose the Belt Lock-Off

- A.** Loosen the harness straps.
- B.** Raise the headrest to the highest position.
- C.** Unbuckle the buckle.
- D.** Unbuckle the chest clip.
- E.** Lift bottom seat pad up to expose the plastic shell.

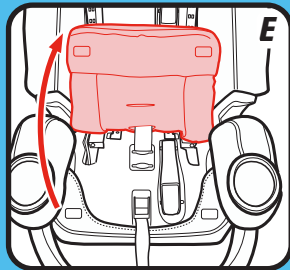
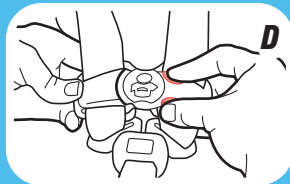
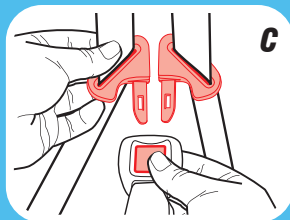
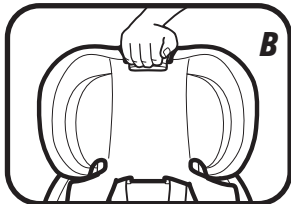
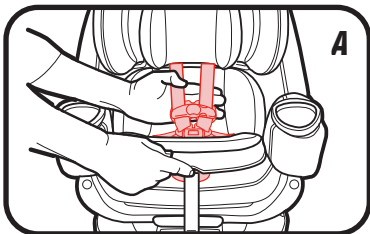



3-C Rear Facing
with Seat Belt

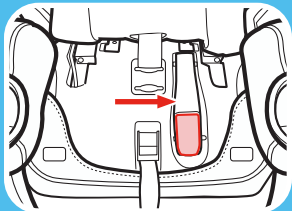

3-C Rear Facing with Seat Belt

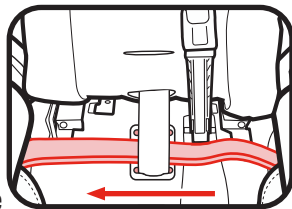
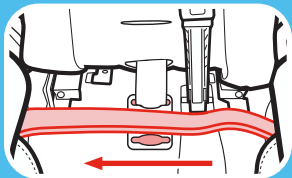
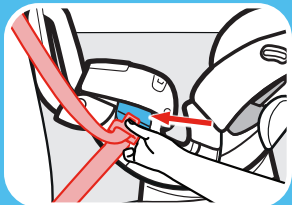

Review your vehicle's owner manual for vehicle seat belt use



10. **Open the SnugLock® Lock-Off**

Lift the lever to open the SnugLock® lock-off.

11. **Route the Vehicle Seat Belt Under the SnugLock® Lock-off**

Thread vehicle seat belt through the rear-facing belt path (marked with a blue label), through the SnugLock® Lock-Off, and out the other side. Buckle the seat belt. The seat belt should lie as flat as possible and not be twisted.

Make sure the vehicle seat belt is in front of the buckle strap when the buckle is in the inner-most position, and behind when in the outer-most position.

12. Tighten the Vehicle Seat Belt

Press down firmly in the center of the car seat. Pull on the shoulder belt to tighten while feeding the slack back in the retractor. Do not pull on the strap with excessive force.

13. Close the SnugLock® Lock-Off

When the slack is removed, close the SnugLock® Lock-Off until you hear a “Click”. Make sure the vehicle seat belt is under the SnugLock® Lock-Off.

⚠ WARNING!

Keep hands away from the lock-off area when closing the lock-off.

14. Test For Tightness

Grab the sides of the seat where the vehicle seat belt is and slide the car seat side-to-side and front-to-back. If the seat moves less than 1” (2.5 cm), it is tight enough.

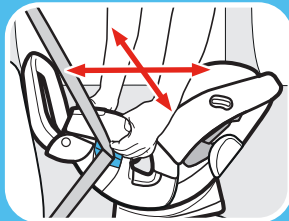
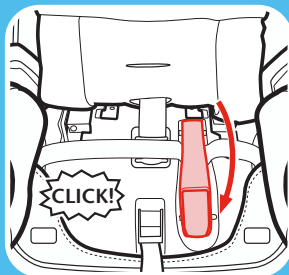
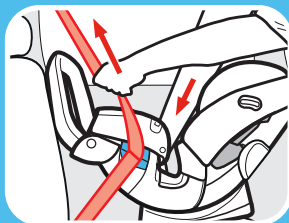

3-C
Rear Facing
with Seat Belt



3-C Rear Facing with Seat Belt

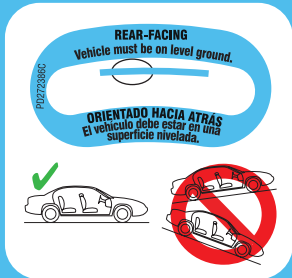
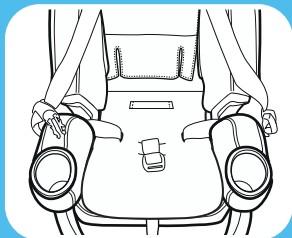

15. Switch the Retractor

Switch the retractor after the installation is complete to avoid a possible strangulation risk.

16. Replace the Seat Pad

Move the headrest back to its proper position for your child.

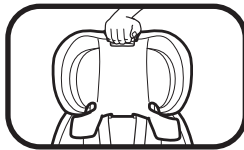

17. Check the Level Indicator

Vehicle **MUST** be on level ground.

Check the level indicator on the car seat. The **bubble must be completely within** the blue zone. Readjust if needed.

See section 5-A to secure your child.

Recheck the level indicator with child in seat.



4-A Forward-Facing Use

Forward-Facing:
26.5-65 lb (12-30 kg)
49" (125 cm) or less



- For children 40 lb or less (18 kg), **MUST** use recline position 5.
- For children over 40 lb (18 kg), **MUST** use recline position 6.
- The outer most buckle slot **MUST** be used when **Forward-Facing**.
- Children are safer riding rear-facing and should ride rear-facing as long as possible, until they reach the maximum rear-facing height or weight rating for their car seat. Then children should ride forward-facing, using the builtin harness system for as long as possible until they reach the maximum forward-facing weight or height for their car seat. At that point, children should ride in a belt-positioning booster seat. Be sure to check your local and state laws, as well as AAP and NHTSA recommendations, for car seat usage.

WARNING! DO NOT USE the Anti-Rebound Bar OR the Leg Extension Panel in the forward-facing mode.

39

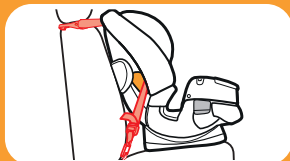

LATCH: Do not install by this method for a child weighing more than 40 lb (18 kg)

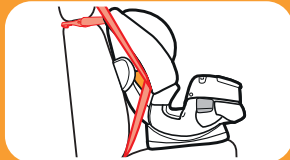

Vehicle Seat Lap/Shoulder Belt with Tether

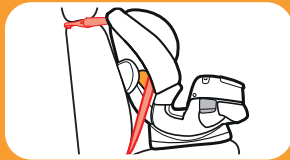

Vehicle Seat Lap Belt with Tether



4-B Install Forward-Facing with LATCH

Review your vehicle's owner manual for LATCH location and use. Do not install by this method for a child weighing more than 40 lb (18 kg).

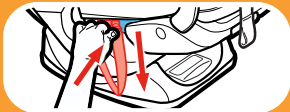

1. Remove Lower Anchor Connectors from Storage Location

Push in on the red buttons on the lower anchor connectors and remove from storage position.

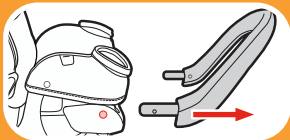

2. Remove Anti-Rebound Bar

DO NOT use the Anti-Rebound Bar in forward-facing mode. The Anti-Rebound Bar can **ONLY** be used in rear-facing mode.

See section 9 to remove the Anti-Rebound Bar.



3. Make Sure Lower Anchor Strap is in the Forward-Facing Belt Path Marked with Orange Label

To move the lower anchor attachment, review section 7.

4. Unhook Tether From Storage

Unhook tether and lay it in the seat.

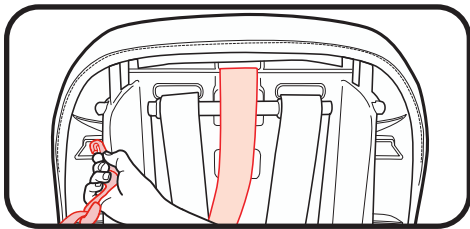

5. Recline the Car Seat

For children 40 lb or less (18 kg), **MUST** use recline position 5.

For children over 40 lb (18 kg), **MUST** use recline position 6 and must install with vehicle seat belt instead of LATCH. See section 4-C.

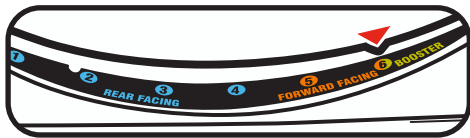

41



4-B Forward-Facing
with LATCH

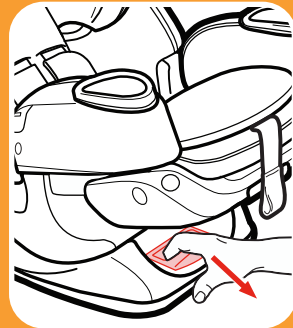
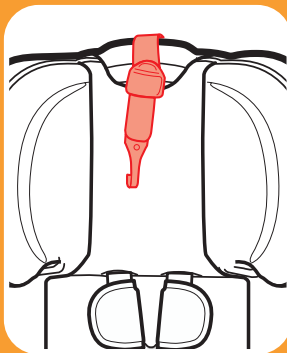

4-B Forward-Facing
with LATCH

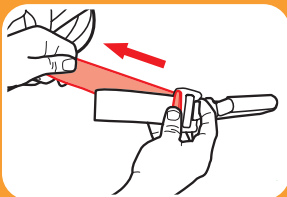
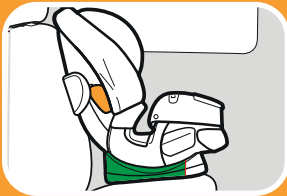
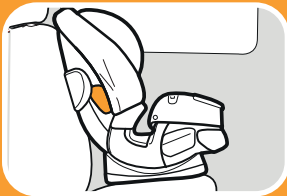

6. Place Car Seat Forward-Facing in Back Seat of the Vehicle

Place forward-facing in vehicle seat and center the car seat between the lower anchors. The base should sit as flat as possible on the vehicle seat.

7. Make Sure Base is a minimum of 80% on Vehicle Seat.



8. Extend the Lower Anchor Strap

For easier installation, extend the lower anchor strap to its maximum length by pressing the grey button and pull out on the strap.

Using With the Belt Lock-Off:

9. Expose the Belt Lock-Off

- A.** Loosen the harness straps.
- B.** Raise the headrest to the highest position.
- C.** Unbuckle the buckle.
- D.** Unbuckle the chest clip.
- E.** Lift the headrest pad flap up out of the way.
- F.** Unsnap Bottom Seat Pad.

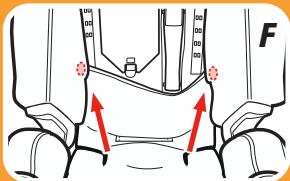
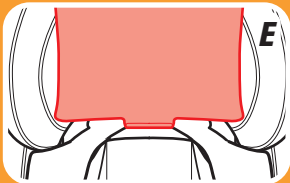
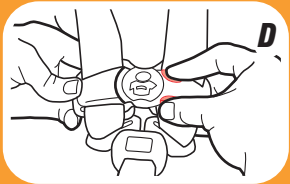
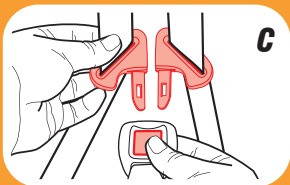
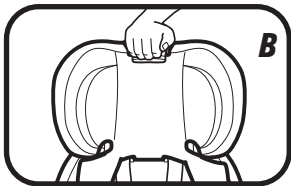
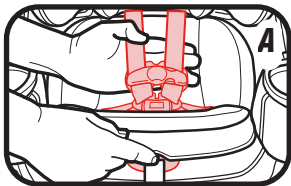

4-B
Forward-Facing
with LATCH

4-B Forward-Facing
with LATCH

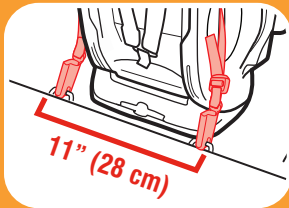
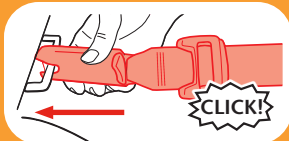
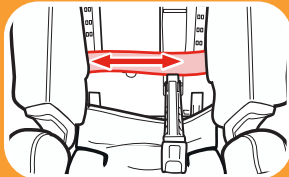
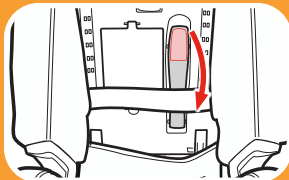

10. Open the SnugLock® Lock-Off

Lift the lever to open the SnugLock® lock-off.

11. Make Sure the Lower Anchor Strap is Routed Under the SnugLock® Lock-Off

The lower anchor strap should lie as flat as possible and not be twisted.

12. Connect the Lower Anchor Connectors to Vehicle's Lower Anchors

Make sure the arrows are pointing up.

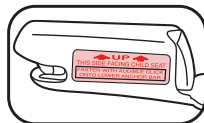

Lower anchor strap should not be twisted. If twisted, you will not be able to tighten the strap.

Lower anchor connectors can only be used if the vehicle lower anchor spacing is 11 inches (28 cm) from the center of one lower anchor to the center of the other lower anchor.

13. Tighten the Lower Anchor Strap

Press down firmly in the center of the car seat while tightening the lower anchor strap. You may need to tighten through the slit in the pad at the belt path as shown. Do not pull on the strap with excessive force.

14. Close the SnugLock® Lock-Off

When the slack is removed, close the SnugLock® Lock-Off until you hear a “Click”. Make sure the Lower Anchor strap is under the SnugLock® Lock-Off.

WARNING! Keep hands away from the lock-off area when closing the lock-off.

15. Attach Tether

Extend the tether by lifting up on the tether lock and attach. Consult vehicle’s owner manual for specific location.

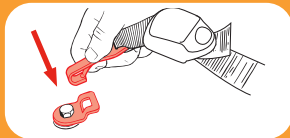
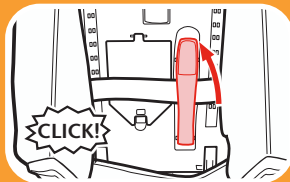
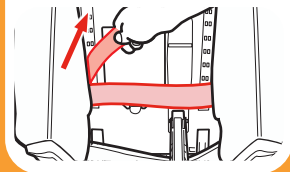
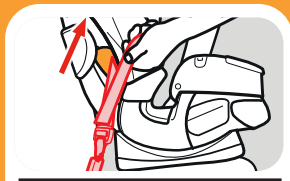
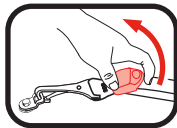

4-B Forward-Facing
with LATCH

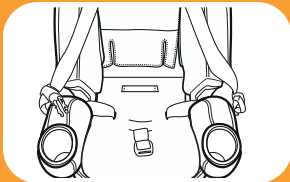
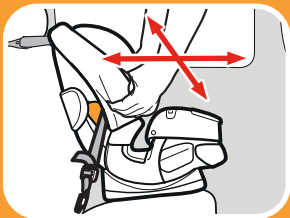
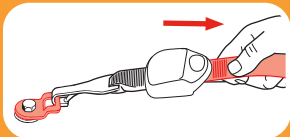

16. Tighten Tether Strap

Remove all the slack.

17. Test For Tightness

Grab the sides of the seat where the lower anchor strap is and slide the car seat side-to-side and front-to-back.

If the seat moves less than 1" (2.5 cm), it is tight enough.

See section 5-A to secure your child.

18. Replace the Seat Pad

Move the headrest back to its proper position for your child.

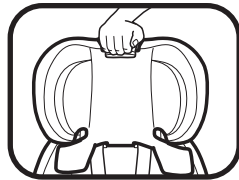



4-C Forward-Facing with Seat Belt

4-C Install Forward-Facing with Vehicle Seat Belt

1. Make Sure Lower Anchor Strap is in the Rear-Facing Belt Path Marked With a Blue Label

If not, See section 7 to move lower anchor attachment.

2. Store Lower Anchor Connectors in Storage Location

Attach lower anchor connectors to the plastic bars as shown.

3. Remove Anti-Rebound Bar

DO NOT use the Anti-Rebound Bar in forward-facing mode. The Anti-Rebound Bar can **ONLY** be used in rear-facing mode.

See section 9 to remove the Anti-Rebound Bar.

4. Unhook Tether From Storage

Unhook tether and lay it in the seat.

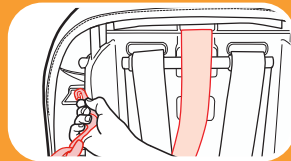
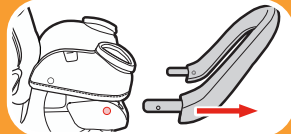
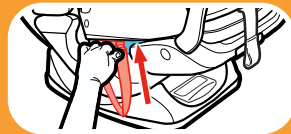
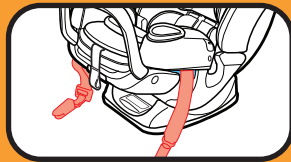
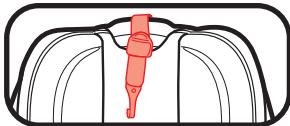

4-C Forward-Facing with Seat Belt

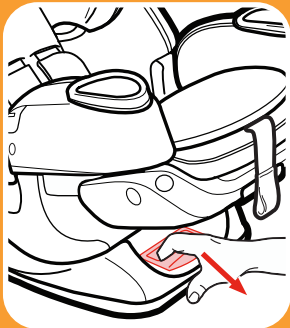
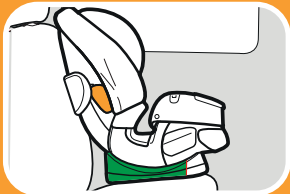

5. Place Car Seat Forward-Facing in Back Seat of the Vehicle

Place forward-facing in vehicle seat. The base should sit as flat as possible on the vehicle seat.

6. Make Sure Base is a minimum of 80% on Vehicle Seat



7. Recline the Car Seat

For children 40 lb or less (18 kg), **MUST** use recline position 5.

For children over 40 lb (18 kg), **MUST** use recline position 6.

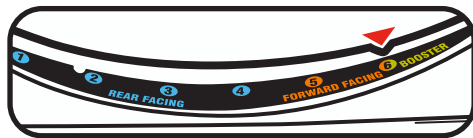

Using With the Belt Lock-Off:

8. Expose the Belt Lock-Off

- A.** Loosen the harness straps.
- B.** Raise the headrest to the highest position.
- C.** Unbuckle the chest clip.
- D.** Unbuckle the buckle.

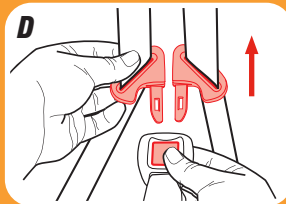
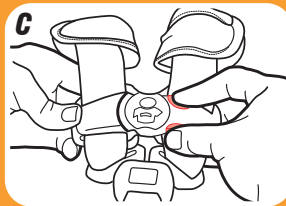
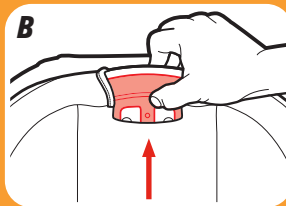
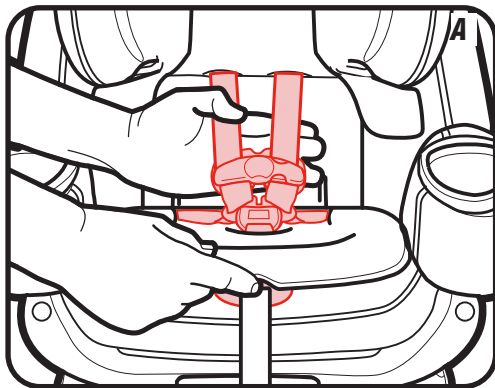

4-C Forward-Facing
with Seat Belt



4-C Forward-Facing with Seat Belt

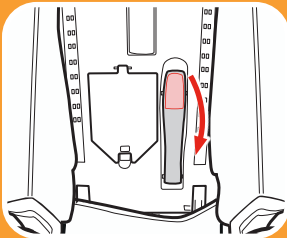
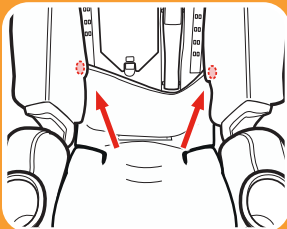
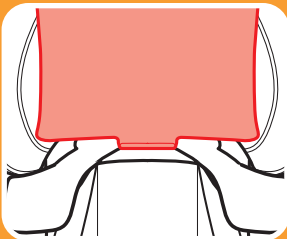

E. Lift the headrest pad flap up out of the way.

F. Unsnap Bottom Seat Pad.

9. Open the SnugLock®- Lock-Off

Lift the lever to open the SnugLock® lock-off.



4-C Forward-Facing with Seat Belt

Review your vehicle's owner manual for vehicle seat belt use

10. Route the Vehicle Seat Belt

Thread vehicle seat belt through the forward-facing belt path (marked with an orange label), through the lock-off, and out the other side. Buckle the seat belt. The seat belt should lie as flat as possible and not be twisted.

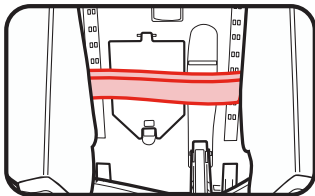

11. Tighten the Vehicle Seat Belt

Press down firmly in the center of the car seat. Pull on the shoulder belt to tighten while feeding the slack back in the retractor. Do not pull on the strap with excessive force.

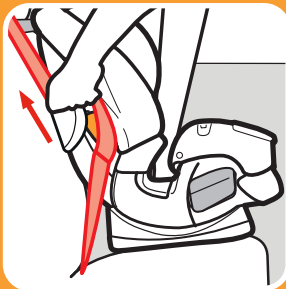
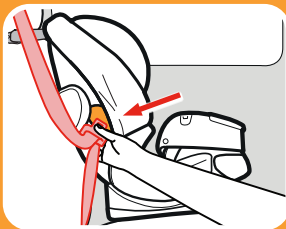

4-C Forward-Facing with Seat Belt

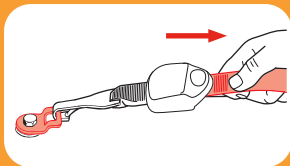
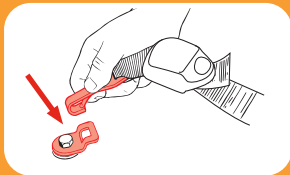
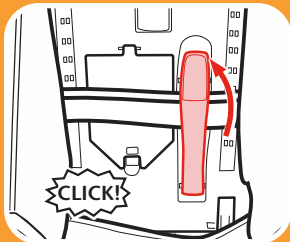

12. Close the SnugLock® Lock-Off

When the slack is removed, close the SnugLock® Lock-Off until you hear a “Click”. Make sure the vehicle seat belt is under the SnugLock® Lock-Off.

⚠ WARNING!

Keep hands away from the lock-off area when closing the lock-off.

13. Attach Tether

Extend the tether by lifting up on the tether lock and attach. Consult vehicle’s owner manual for specific location.

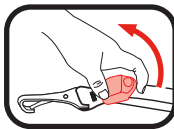

14. Tighten the Tether Strap

Push the car seat back while tightening the tether strap to remove all the slack.

15. *Test For Tightness*

Grab the sides of the seat where the vehicle seat belt is and slide the car seat side-to-side and front-to-back.

If the seat moves less than 1" (2.5 cm), it is tight enough.

See section 5-A to secure your child.

16. *Switch the Retractor*

Switch the retractor after the installation is complete to avoid a possible strangulation risk.

17. *Replace the Seat Pad*

Move the headrest back to its proper position for your child.

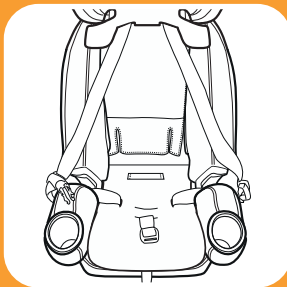
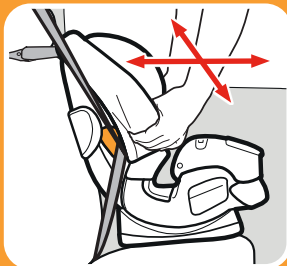
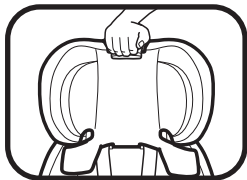

4-C Forward-Facing
with Seat Belt



5-A Securing Child 5-Point Harness

! WARNING!

WARNING! In cold weather, do not put snowsuits or bulky garments on your child when placing them in the car seat. Bulky clothing can prevent the harness straps from being tightened properly. To keep child warm, buckle your child in the car seat and place a blanket around the child or place the child's coat on backwards after buckling in.

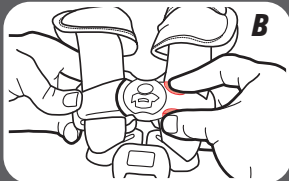
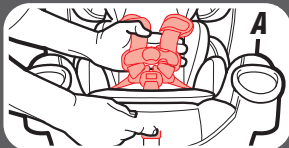

1. Loosen Harness Straps

- (A) Lift up on the harness release lever while pulling out on the harness straps at the chest clip.
- (B) Unbuckle the chest clip and the buckle.
- (C) Place harness straps off to the sides.

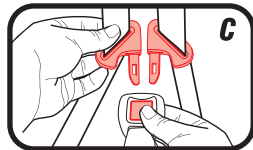

2. Place Your Child in the Seat

Make sure their back is flat against the car seat back.

3. Place Harness Straps Over Child's Shoulders and Buckle

You will hear a “click” when buckle tongues are securely attached. Pull up on each buckle tongue to make sure it is securely attached.

4. Be Sure the Harness Straps Are at the Proper Height

Rear-Facing: Harness straps must be **at or just below** the child's shoulders and top of head **must be at least 1" (2.5 cm) below** the red headrest/harness adjustment handle.

Forward-Facing: Harness straps must be **at or just above** the child's shoulders and top of child's ears **must be below** top of headrest. Remove the infant head and body supports.

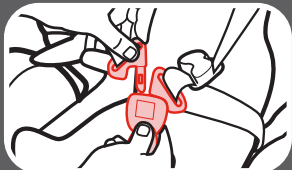

Rear-Facing



Forward-Facing



5 Securing Child 5-Point Harness

5 Securing Child 5-Point Harness

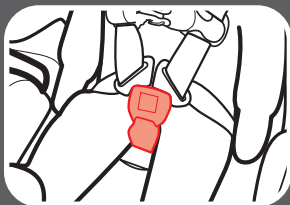
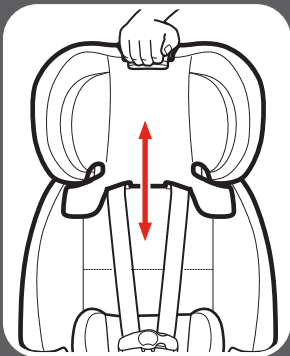

5. **To Raise or Lower Headrest/Harness Adjustment Lever**

Squeeze the adjustment lever and lift or lower headrest for the proper harness height.

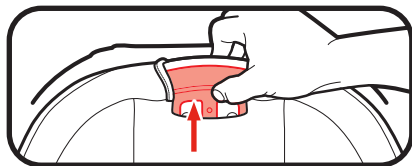

6. **Check the Buckle Position**

The correct slot the one that is closest to your child without being underneath your child.

The outer most buckle slot MUST be used when Forward-Facing.

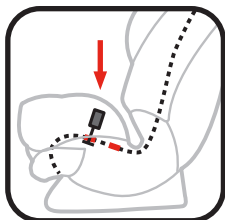

A. Outer Most

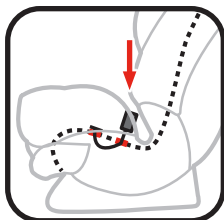

B. Inner Most

7. Follow the Instructions That Matches The Current Buckle Position:

A. To Adjust Buckle Strap When the Buckle is in the Outer Most Position

Extend the footrest, recline the car seat and locate the metal retainer under the car seat shell.

B. To Adjust Buckle Strap When the Buckle is in the Inner Most Position

Unsnap seat pad and expose the top of seat. Locate the metal retainer.

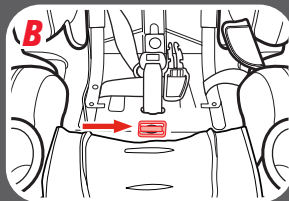
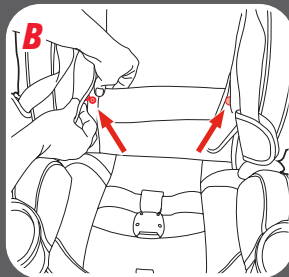
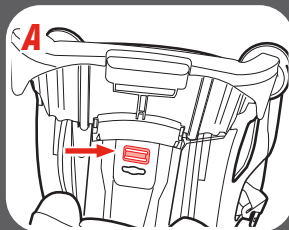

**5 Securing Child
5-Point Harness**

5 Securing Child 5-Point Harness

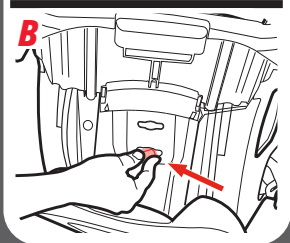
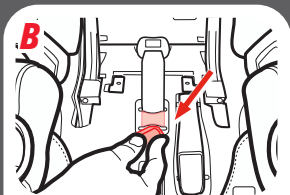
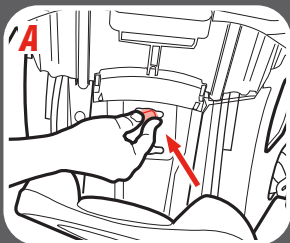

8. Rotate Metal Retainer and Insert It Through the Shell and Pad



A. Outer Most Slot:

Rotate the metal retainer and insert it through the shell and pad. From the top of the car seat, pull the buckle out.



B. Inner Most Slot:

From the top of the car seat, rotate the metal retainer and push the retainer down through shell.



Extend the footrest, recline the car seat and from the bottom of the shell, rotate the retainer and push it up through the inner most slot in the shell.

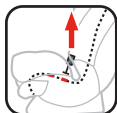

From the top of the car seat, pull the buckle out.

9. Insert Metal Retainer in the New Buckle Strap Slot

The outer most buckle slot **MUST** be used when Forward-Facing.



A. Installing In The Outer Most Slot:

Rotate the metal retainer and push it through the pad and shell. Reach underneath the car seat and pull the metal retainer through pad and shell.

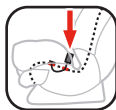

B. Installing In The Inner Most Slot:

Unsnap the seat pad, from the top, rotate the metal retainer and push it through shell.

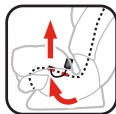

From the bottom, push the retainer back up the outer most slot. Make sure the metal retainer is flush against the top of the plastic shell. Resnap the seat pad.

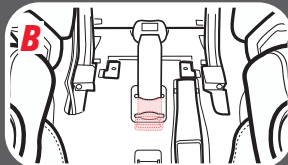
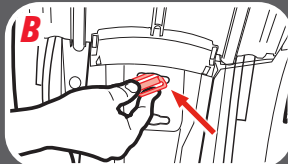
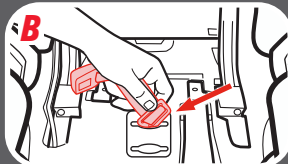
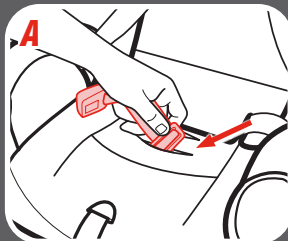

5 Securing Child 5-Point Harness

5 Securing Child 5-Point Harness

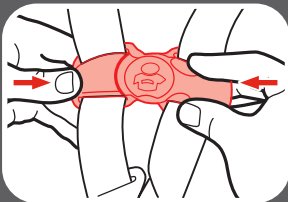
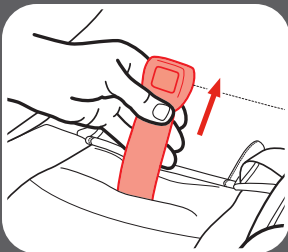

10. Pull Up on Buckle Strap to Make Sure it is Secured

Rear-Facing: Make sure the lower anchor strap is in front of the buckle strap when the buckle is in the inner-most position **(A)**, and in behind when in the outer-most position **(B)** and that it is flat and is not twisted.

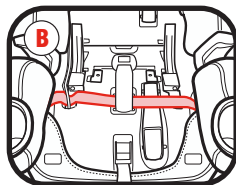
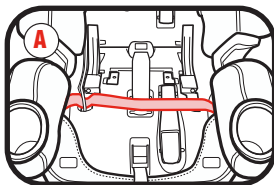

11. Buckle the Chest Clip

You will hear a “click” when the chest clip is securely buckled.

12. Pull All the Slack Out From Around the Waist

Pull up on the harness strap while pushing the chest clip down. Do this to both sides.

13. Tighten the Harness by Pulling the Harness Adjustment Strap

When you are not able to pinch any of the harness webbing at your child's shoulder, the harness is tight enough.

A snug harness should not allow any slack. It lies in a relatively straight line without sagging. It does not press on the child's flesh or push the child's body into an unnatural position.

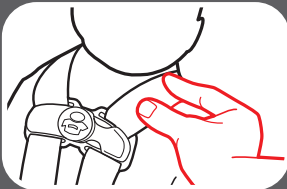
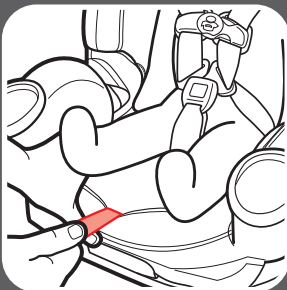
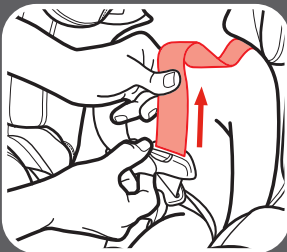

5 Securing Child 5-Point Harness

5 Securing Child
5-Point Harness

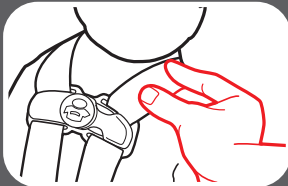
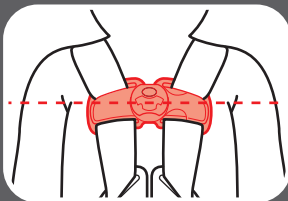

14. Raise the Chest Clip to Child's Armpit Level

15. Check Tightness Again, Tighten More if Needed

6-A Booster Use

Highback Booster:
40-100 lb (18.1-45 kg) 43-57 in.
(110.1-145 cm) at least 4 years old

Backless Booster:
40-120 lb (18.1-54 kg) 43-57 in.
(110.1-145 cm) at least 4 years old



When forward-facing, children should use the built-in harness system for as long as possible until they reach the maximum forward-facing weight or height for their car seat. At that point, children should ride in a belt-positioning booster seat. A booster is no longer needed once the vehicle seat belt fits properly, typically when they reach 4 feet 9 inches (145 cm) tall and are between ages 8-12. Be sure to check your local and state laws, as well as AAP and NHTSA recommendations, for car seat usage.

WARNING! DO NOT USE the Anti-Rebound Bar **OR** the Leg Extension Panel in the booster mode.



**Vehicle Seat Lap/
Shoulder Belt**



**Vehicle Seat Lap/
Shoulder Belt**



6-A
Booster



6-A Booster



Never Use a Vehicle Lap-Only Belt Across Front of Child

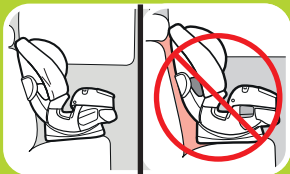

- **DO NOT** position vehicle shoulder belt under the child's arm or back.
- **DO NOT** allow child to slouch or slide down in the booster seat.
- **DO NOT** position vehicle belt over top of armrests.
- Vehicle's seat headrest **SHOULD NOT** create a gap between vehicle seat and booster seat.
- The front of booster seat **MUST NOT** hang over front of vehicle seat.
- If child will not keep vehicle belt properly positioned, **DO NOT** use this booster seat. Use a different car seat.

6-B Install Highback Booster

Highback Booster:
40-100 lb (18.1-45 kg) 43-57 in.
(110.1-145 cm) at least 4 years old



1. Raise the headrest to the highest position.

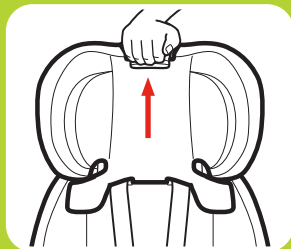

2. Remove Anti-Rebound Bar

DO NOT use the Anti-Rebound Bar in booster mode. The Anti-Rebound Bar can **ONLY** be used in rear-facing mode.

See section 9 to remove the Anti-Rebound Bar.

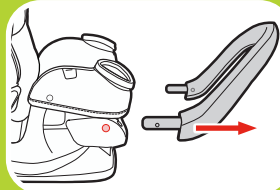

3. Store The Harness System

A. Loosen the shoulder straps as much as possible.

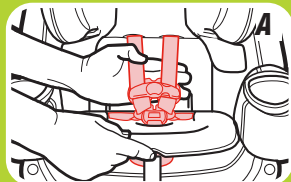

**6-B Highback
Booster**

6-B Highback Booster

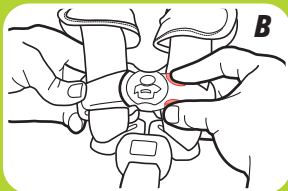

B. Unbuckle the chest clip and the buckle strap as shown

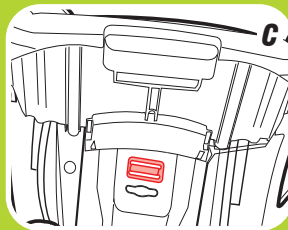
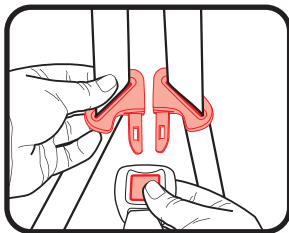

C. Remove the Buckle Strap

Extend the extension panel, recline the car seat to position 1, then locate the metal retainer under the car seat shell.



D. Rotate Metal Retainer and Insert It Up Through the Shell and Pad

From the top of the car seat, pull the buckle out.

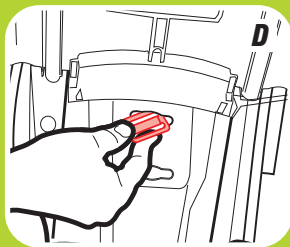

E. Lift the headrest pad flap up out of the way

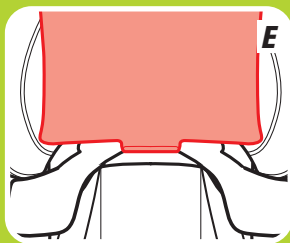

**6-B Highback
Booster**



6-B Highback Booster

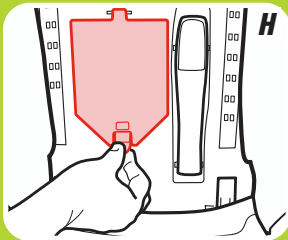
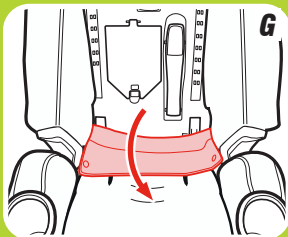
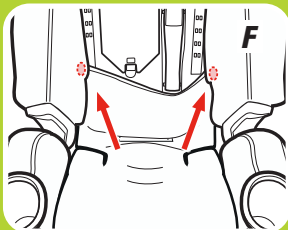

F. Unsnap Bottom Seat Pad

Undo the 2 lower snaps.

G. Pull Bottom Seat Pad Back To Expose the Plastic Shell

H. Open the Harness Storage Door

I. Place Harness, Chest Clip, Buckle, Buckle Tongues, and Harness Covers Inside the Storage Compartment. and Close the Door

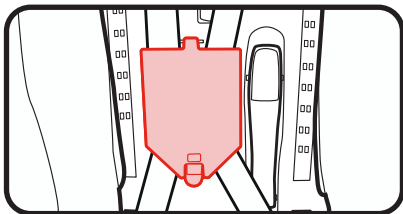

J. Replace Seat Pad

Move the headrest back to its proper position for your child.

Move the extension panel to position 1.

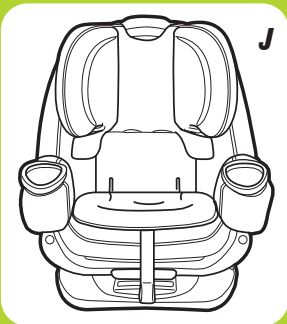
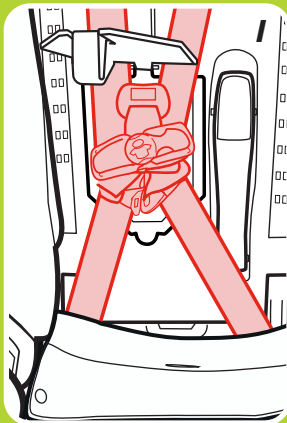

**6-B Highback
Booster**



6-B Highback Booster

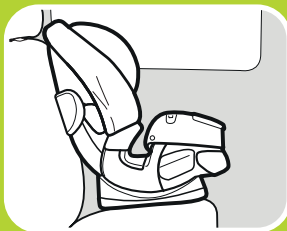
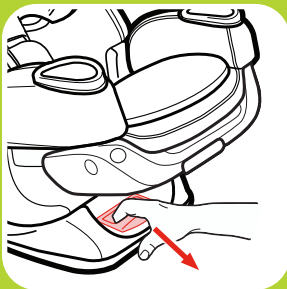
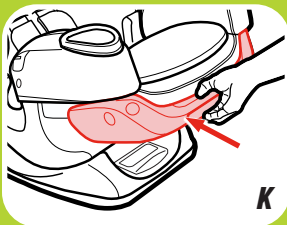

K. Move the Extension Panel to Position 1

4. Recline the Car Seat

Place the car seat in the 6th recline position.

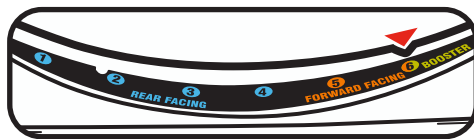

5. Place the Booster Seat Forward-Facing in the Back Seat of Vehicle

Place forward-facing on a vehicle seat that has a lap/shoulder seat belt. The base should sit as flat as possible on the vehicle seat.

Graco allows the securing of the car seat with LATCH in the booster mode only if the vehicle manufacturer allows it. The child still **MUST BE SECURED** with the vehicle lap/shoulder seat belt. LATCH can be used in the booster mode regardless of the weight of the child up to 100 lb (45 kg). Verify the following before using LATCH in the booster mode:

- The lower anchor connectors **DO NOT** interfere with any vehicle seat belts or buckles.

If the lower anchor connectors interfere with the vehicle seat belts or if the chosen seating position does not have lower anchors, you **MUST** store the lower anchor connectors. Store the lower anchor connectors in the storage location as shown. Store the tether as shown. Always secure car seat with lower anchor attachment or a vehicle seat belt, even when unoccupied. In a crash, an unsecured car seat can injure passengers.

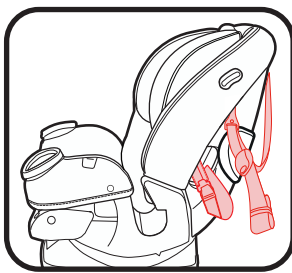

6-B Highback Booster



Skip to Step 19 if Not Using LATCH

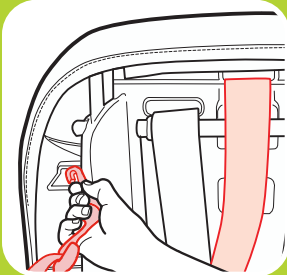
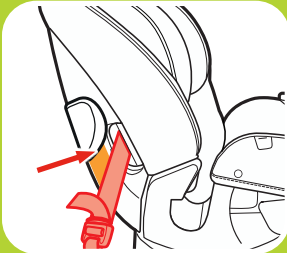
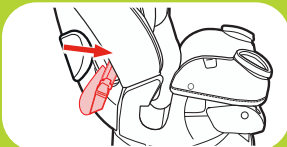

6. Remove Lower Anchor Connectors from Storage Location

Push in on the red buttons on the lower anchor connectors and remove from storage position.

7. Make Sure Lower Anchor Strap is in the Forward-Facing Belt Path Marked with Orange Label

To move the lower anchor attachment, review section 7.

8. Unhook Tether From Storage Location and Lay it in the Seat

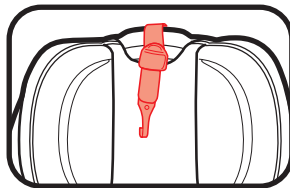

9. Extend the Lower Anchor Strap

For easier installation, extend the lower anchor strap to its maximum length by pressing the grey button and pull out on the strap.

Using With the Belt Lock-Off:

10. Expose the Belt Lock-Off

- A.** Raise the headrest to the highest position.
- B.** Lift the headrest pad flap up out of the way.
- C.** Unsnap Bottom Seat Pad.

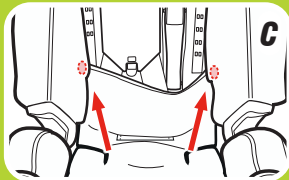
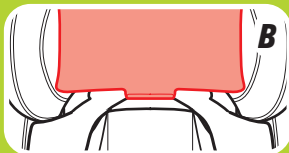
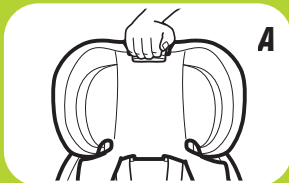
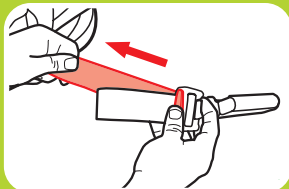

**6-B Highback
Booster**



6-B Highback Booster

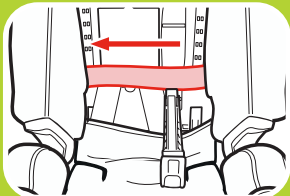
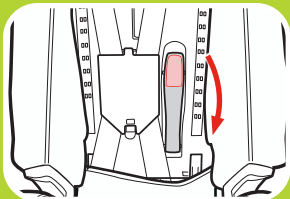

11. Open the SnugLock® Lock-Off

Lift the lever to open the SnugLock® lock-off.

12. Make Sure the Lower Anchor Strap is Routed Under the SnugLock® Lock-Off

The lower anchor strap should lie as flat as possible and not be twisted.

13. **Connect the Lower Anchor Connectors to Vehicle's Lower Anchors**

Make sure the arrows are pointing up.

Lower anchor strap should not be twisted. If twisted, you will not be able to tighten the strap.

Lower anchor connectors can only be used if the vehicle lower anchor spacing is 11 inches (28 cm) from the center of one lower anchor to the center of the other lower anchor.

14. **Remove The Slack From The Lower Anchor Strap**

Do not pull on the strap with excessive force.

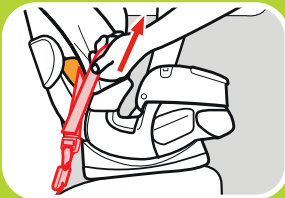
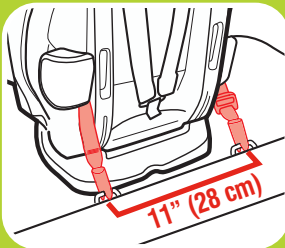
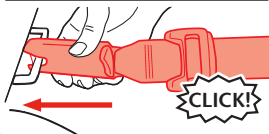
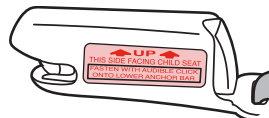

**6-B Highback
Booster**

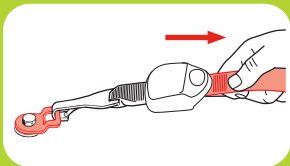
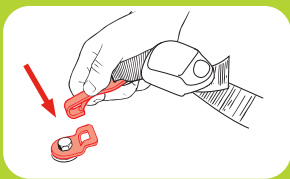
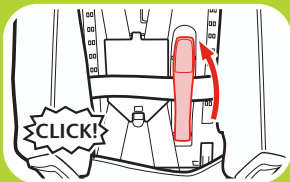

15. Close the SnugLock® Lock-Off

When the slack is removed, close the SnugLock® Lock-Off until you hear a “Click”. Make sure the Lower Anchor strap is under the SnugLock® Lock-Off.

WARNING! Keep hands away from the lock-off area when closing the lock-off.

16. Attach Tether

Extend the tether by lifting up on the tether lock and attach.

Consult vehicle’s owner manual for specific location.

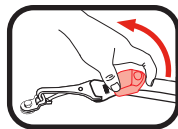

17. Tighten Tether Strap

Remove all the slack.

18. Replace Seat Pad

Move the headrest back to its proper position for your child.

19. Thread the Vehicle Seat Shoulder Belt Through Seat Belt Guide on the Headrest

See section 6-D to secure your child.

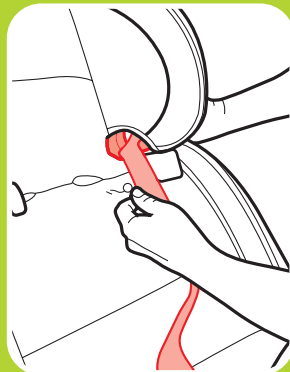

**6-B Highback
Booster**



6-C Install Backless Booster

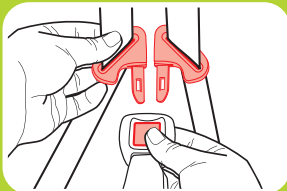
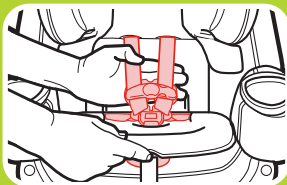
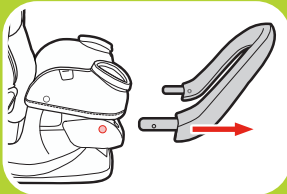

Backless Booster:
40-120 lb (18.1-54 kg) 43-57 in.
(110.1-145 cm) at least 4 years old



1. Remove Anti-Rebound Bar

DO NOT use the Anti-Rebound Bar in booster mode. The Anti-Rebound Bar can **ONLY** be used in rear-facing mode.

See section 9 to remove the Anti-Rebound Bar.

2. Remove the Seat Back by First Loosening the Harness Straps

Lift up on the harness release lever while pulling out on the harness straps at the chest clip.

Unbuckle the chest clip and the buckle strap.

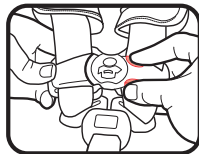

3. Remove Harness Straps from Splitter Plate

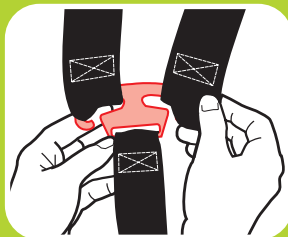

4. Make Sure Lower Anchor Strap is in the Forward-Facing Belt Path Marked with an Orange Label and in the Stored Position

To move the lower anchor attachment, review section 7.

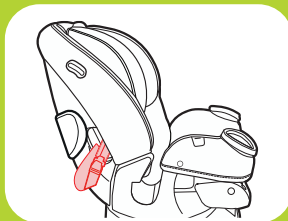

5. Unsnap Bottom Seat Pad

Unsnap seat pad and expose the bottom of seat base.

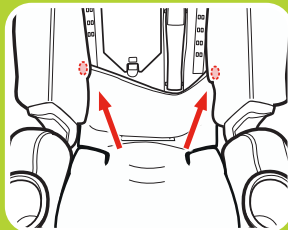

6-C
Backless
Booster

6-C Backless Booster

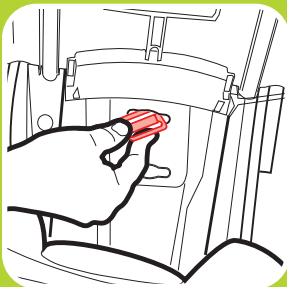
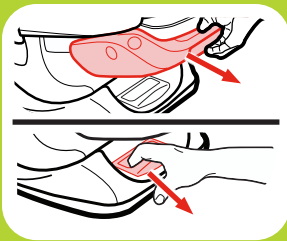

6. Remove the Buckle Strap

Extend the extension panel, recline the car seat to position 1, then locate the metal retainer under the car seat shell.

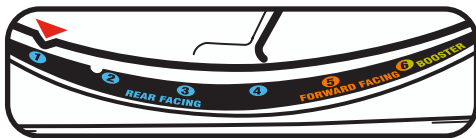

7. Rotate Metal Retainer and Insert It Up Through the Shell and Pad

From the top of the car seat, pull the buckle out.

8. Adjust the Seat to Recline Position 6 and Move the Extension Panel to Position 1

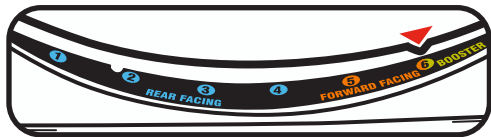

9. Lift the Red Backrest Locks Up

With the car seat in the 6th recline position, lift the red backrest locks up and slide together.

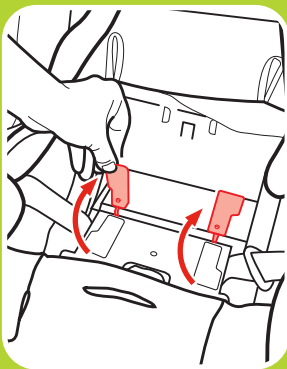
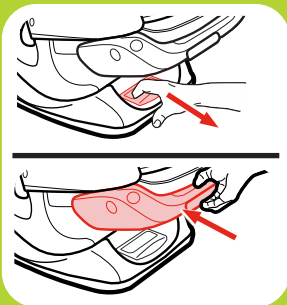
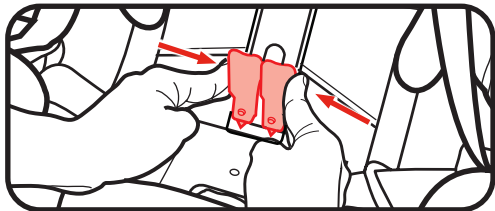

**6-C
Backless
Booster**

6-C Backless Booster

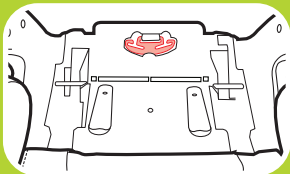
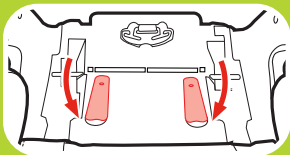
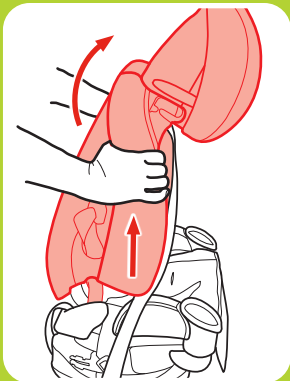

10. Remove Seat Back from Seat Base

Push the seat back forward and lift out of base.
To replace the seat back, reverse the steps.

11. Relock the Red Backrest Locks

Make sure they are both flat and locked into place

12. Store Splitter Plate

Pull the harness adjustment strap all the way out and then store the splitter plate.

13. Attach Base Pad to the Back of Base

Attach the elastic straps onto base as shown.

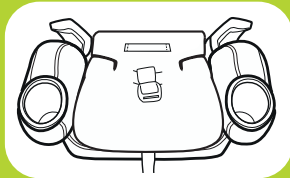
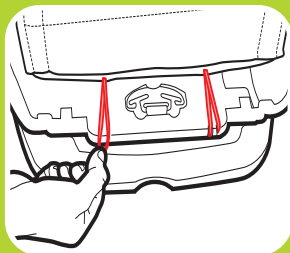
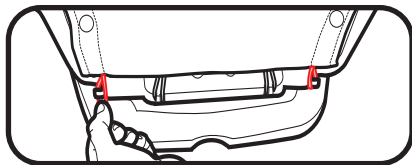

14. Place the Booster Seat Forward-Facing in the Back Seat of Vehicle

Place forward-facing on a vehicle seat that has a lap/shoulder seat belt. The base should sit as flat as possible on the vehicle seat.

See section 6-E to secure your child.



6-C
Backless
Booster



6-D Securing Child Highback Booster

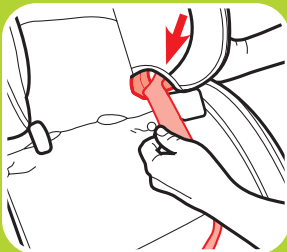

!WARNING!

WARNING! Use only the vehicle lap and shoulder belt system when restraining the child in the booster seat.

1. Place Child In Seat

Have your child sit in the booster seat, with his/her back flat against the back of the booster seat.

2. Thread Vehicle's Shoulder Belt Into Seat Belt Guide in the Headrest

3. Buckle the Vehicle Lap/Shoulder Seat Belt

Be sure the lap portion of the vehicle seat belt goes behind the armrests.

Be sure the lap portion of the vehicle seat belt lies low across your child's hips.

Be sure the shoulder belt lies across your child's shoulders, between the neck and edge of shoulder. The belt guides should be even with or just above the shoulders.

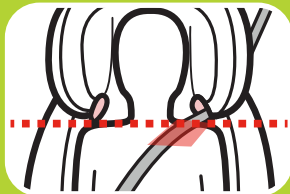
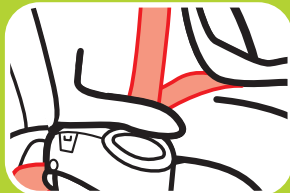
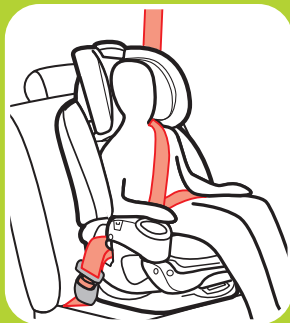

6-D Securing Child
Highback Booster



6-E Securing Child Backless Booster

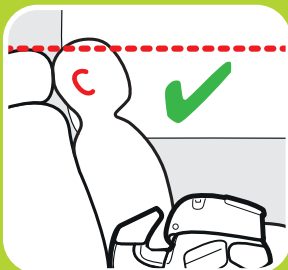
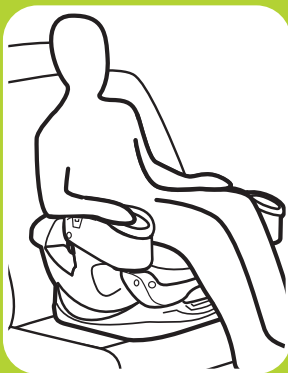

!WARNING!

WARNING! Use only the vehicle lap and shoulder belt system when restraining the child in the booster seat.

1. Place Child In Seat

Have your child sit in the booster seat, with his/her back flat against the back of the vehicle seat.

2. Ears Must Be Below the Top of the Vehicle Seat Back or Headrest

3. Buckle the Vehicle Lap/Shoulder Seat Belt

Be sure the lap portion of the vehicle seat belt goes behind the armrests.

Be sure the lap portion of the vehicle seat belt lies low across your child's hips.

Be sure the shoulder belt lies across your child's shoulders, between the neck and edge of shoulder.

You may need to use the belt positioning clip to help get a good fit.

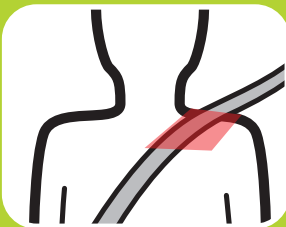

6-E Securing Child
Backless Booster

Using Belt Positioning Clip

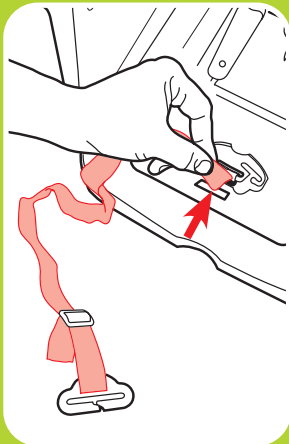
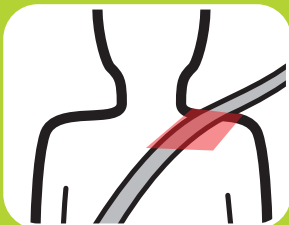

1. Make Sure Vehicle's Seat Shoulder Belt Lays in the Red Zone As Shown

If the vehicle's seat shoulder belt lays outside this zone, you **MUST** use the belt positioning clip.

2. Attach Belt Positioning Clip

Insert the loop end of the strap through the outer slot next to the harness adjustment strap as shown.

3. Push Clip and Strap Through Loop

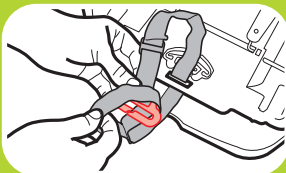

4. Pull to Tighten Strap

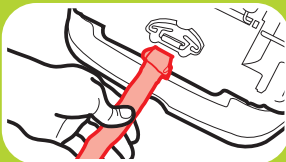

5. Push Clip Through Slot In Pad

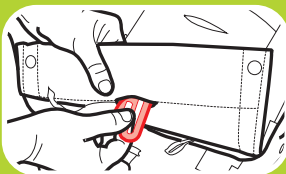

6. Attach Seat Pad to Base

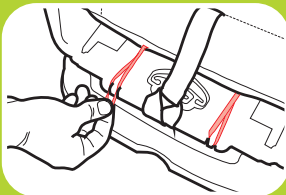

6-E Securing Child
Backless Booster

6-E Securing Child
Backless Booster

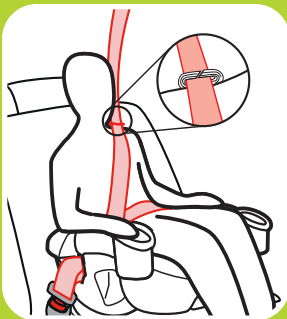

Lengthen

Shorten

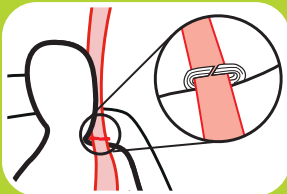
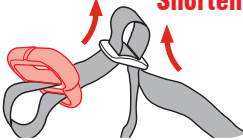

7. Place Child in Seat, Buckle Child In Seat and Attach Belt Positioning Clip

With child's back flat against the back of the vehicle seat, buckle child in. Then slide the clip onto the vehicle's seat shoulder belt as shown.

8. Adjust the Belt Positioning Clip to Fit Your Child

Lengthen or shorten the belt length as shown.

Clip should fit right at the top of shoulder as shown.

7-A Moving the Lower Anchor Attachment

1. For Ease of Moving the Lower Anchor Attachment

- A. Loosen the harness straps.
- B. Raise the headrest to the highest position.
- C. Unbuckle the chest clip.
- D. Unbuckle the buckle.

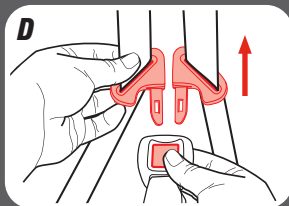
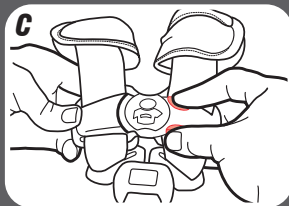
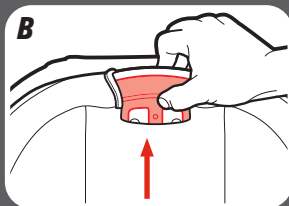
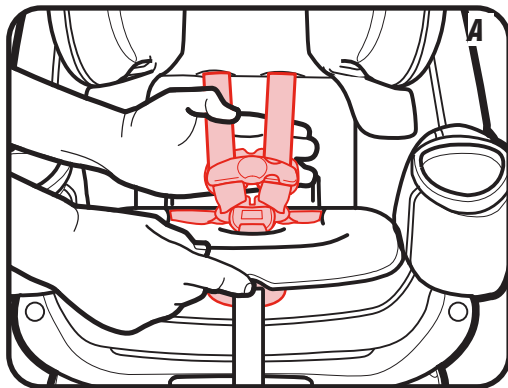

91

7 Moving Lower Anchor Attachment

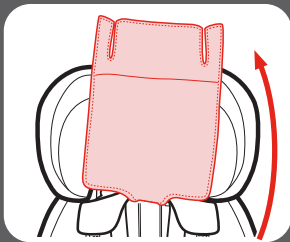

2. Lift The Headrest Pad Flap Up Out Of The Way

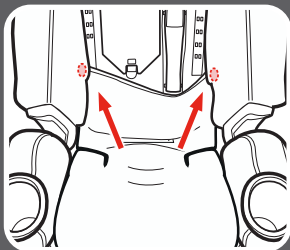

3. Unsnap Bottom Seat Pad

Undo the 2 lower snaps.

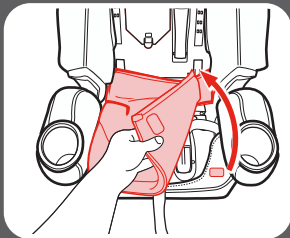

4. Completely Remove The Seat Pad Back To Expose the Plastic Shell

5. Pull the Lower Anchor Connectors Out of the Belt Path Openings

Pull the lower anchor connectors out of the belt path openings, so that the lower anchor connectors lay in the seat.

6. Slide Entire Lower Anchor Strap Along Bar to the Desired Belt Path Openings

Rear-Facing: Slide lower anchor strap along bar to the front of the seat.

Forward-Facing: Slide the lower anchor strap up along bar to the top.

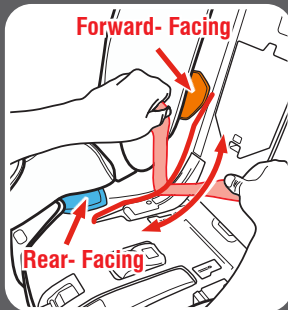
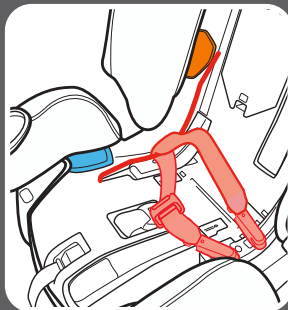

7 Moving Lower Anchor Attachment

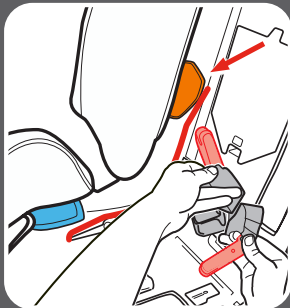
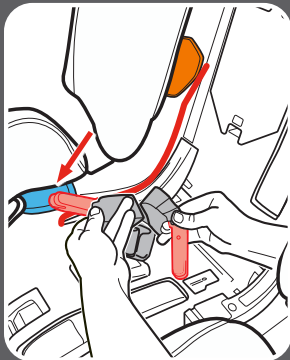

7. Push the Lower Anchor Connectors Out Through the Desired Belt Path Openings on Each Side of Car Seat

Rear-Facing: Make sure the Lower Anchor strap is in front of the buckle strap when the buckle is in the inner-most position (A), and behind when in the outer-most position (B) and that it is flat and is not twisted.

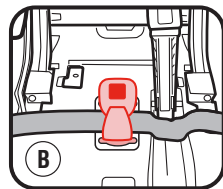
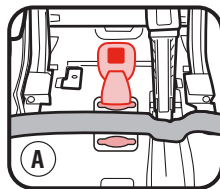

Forward-Facing: Make sure the lower anchor strap is routed behind the harness strap, is flat, and is not twisted.

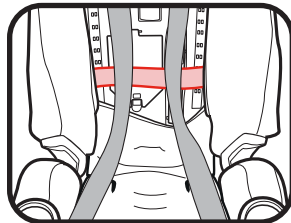

8. Replace the Seat Pad

9. Move the Headrest to Its Proper Position for Your Child

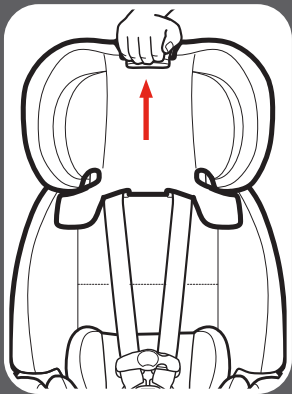
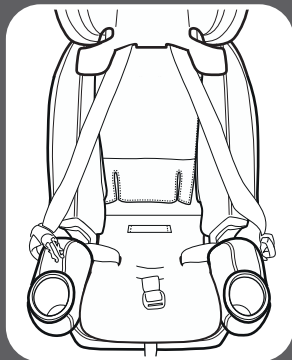

7 Moving
Lower Anchor Attachment

8 Accessories *(on select models)*

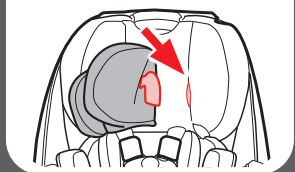
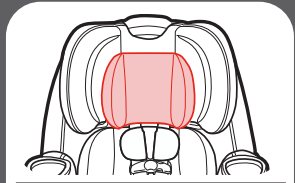
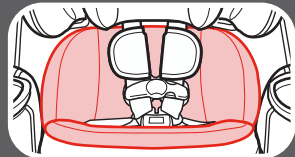
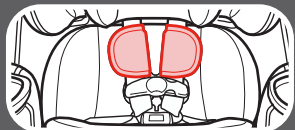

! WARNING!

To prevent ejection in sudden stop or crash: The infant head support and body support can be used only for children weighing 20 lb (9 kg) or less.

Harness Covers

Make sure that harness covers do not interfere with placement of the chest clip at armpit level.

To remove, undo the fastening strips and remove.

Infant Body Support

Use only in the rear-facing mode. Body support must be used if shoulders are below the lowest harness setting.

Never allow body support to bunch or fold behind child.

Infant Head Support

Use only in the rear-facing mode.

To install, insert the tabs on the back of the infant head support into the slots on the headrest.

To remove, undo the fastening strips and pull the straps out of the headrest.

Seat Insert

The seat insert **MUST** be used for children **40 lb (18 kg) or less**.

The seat insert **MUST** be removed for children **over 40 lb (18 kg)**.

Never allow seat insert to bunch or fold behind child.

To install, unbuckle the harness and attach the pins on each side of the seat insert into the holes near the seat crease just behind the booster belt guide.

Then, route the buckle through the same slot in the seat insert.

Push the side pads of the seat insert as far back into the seat as possible after installing. Make sure harness straps are routed through the seat insert and are not twisted.

To remove, unbuckle the harness and pull out the pins on each side.

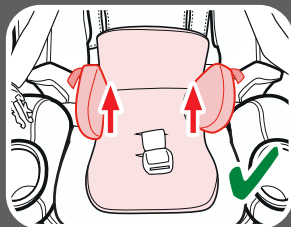
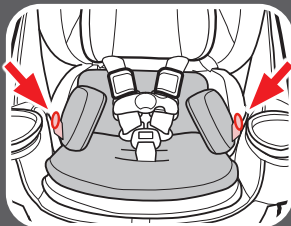
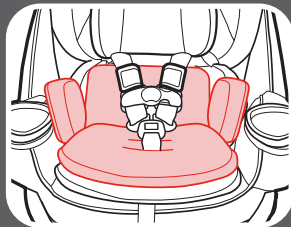

9 Anti-Rebound Bar

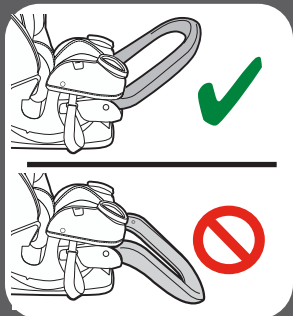
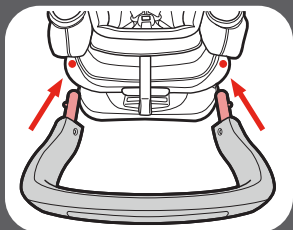

Attaching the Anti-Rebound Bar (Rear-Facing Only)

- The Anti-Rebound Bar can **ONLY** be used in rear-facing mode. **DO NOT** use the Anti-Rebound Bar in forward-facing or booster mode.

Insert the ends of the Anti-Rebound Bar into the holes on the front of the car seat until the bar **CLICKS** into place.

Install with the Anti-Rebound Bar rising upwards. **DO NOT** install with the Anti-Rebound Bar dipping downwards.

- Do not carry the car seat by holding onto the Anti-Rebound Bar.

Removing the Anti-Rebound Bar

Push the buttons on both sides of the car seat at the same time to remove the Anti-Rebound Bar.

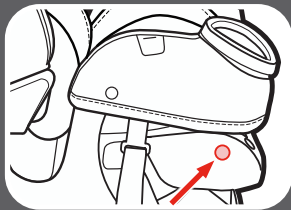
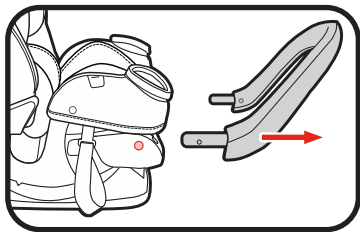

9 Anti-Rebound Bar

10-A How to Uninstall Lower Anchor Connectors and Tether

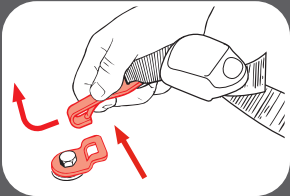
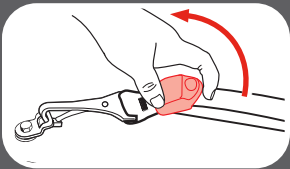
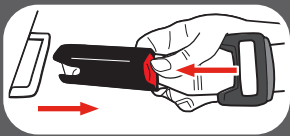

Lower Anchor Connectors

To remove the lower anchor connectors from the lower anchors, push in on the red buttons and pull them off.

Tether

To remove, lift up on the tether lock to release the tension.

Press in on the hook's spring. Push tether hook in, then lift up and pull away from tether anchor.

10-B Which Installation Method Should I use?

This car seat can be installed in your vehicle using either the vehicle seat belt **OR** the lower anchor attachment. Both are equally safe to use. **INSTALL USING ONLY ONE METHOD.**

Vehicle Seat Belt: Review this section and your vehicle owner's manual to learn how to install your car seat with the vehicle seat belts.

LATCH or Lower Anchor Attachment: The LATCH system or lower anchor attachment allows you to securely attach your safety seat in your car without using the vehicle seat belt and possibly to get a better fit. All 2003 and newer model year vehicles are required to have a LATCH system, although some manufacturers began including LATCH earlier. Some vehicle owner manuals use the term ISOFIX to identify the LATCH system. **Review your vehicle's owner manual for exact location and use.**



Vehicle's Tether
Anchor

Vehicle Seat Belt

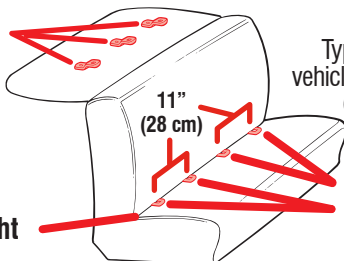

101

Typical seat in a passenger vehicle. Locations may vary from one vehicle to another.

Vehicle's Lower
Anchor





10-C Choosing Vehicle Seat Location

Review your vehicle's owner manual for Seating Locations

The best seating location for this car seat is one that:

- Is recommended by your vehicle owner's manual, and
- Results in a secure installation of this car seat

In the event there is no available back seat and / or you have no other option than to place a child other than an infant in a rear-facing car seat in a front passenger seating position, the National Highway Traffic Safety Administration (NHTSA) recommends that you take the following steps:

- Ensure the child is properly restrained according to their age and size
- Move the seat as far back as possible
- Make sure the child is not leaning out of position, such as leaning forward into the deployment path of the air bag
- Set the air bag ON-OFF switch, if available, to the OFF position
- Move the seat as far back as possible

10-D Unsafe Vehicle Seat Location

Never install this car seat in any of the following vehicle seating locations:



rear-facing or side-facing
vehicle seats



rear-facing with an active
front air bag



booster mode with vehicle
lap belt only seat belt

10-E Vehicle Seat Belts

Review your vehicle's owner manual for vehicle seat belt use

This car seat can be installed using a vehicle seat belt. To do this, you will need to change the seat belt to a locked mode for use with car seats. With some vehicle seat belts, this is done with the latchplate; with other vehicle seat belts, this is done with the retractor.

Vehicle Seat Belt Terms

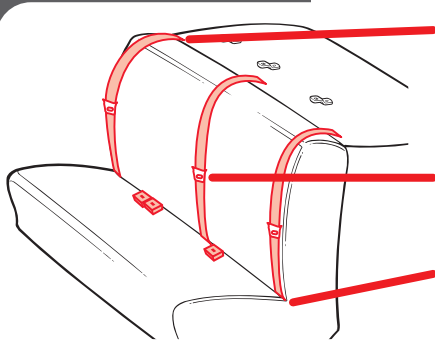

Retractor

A device that winds up the unused vehicle seat belt. It is often hidden inside the panels on the walls of the vehicle or in the vehicle seatback.

Latch Plate

The male end of the seat belt with the silver tongue.

Seat Bight

The crease where the vehicle seat back and seat bottom meet.

Identify Your Seat Belt Type

There are two different types of vehicle seat belts that can be used with this car seat:

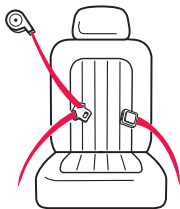

Lap/Shoulder Belt

3 connection points. Can be used in all car seats modes of use.

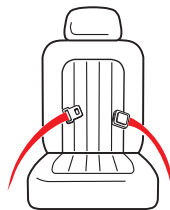

Lap Belt Only

2 connection points. **Can ONLY be used in harness mode.**

The following types of vehicle seat belts **CANNOT** be used safely with this car seat:



Lap Belt with Motorized Shoulder Belt



Lap Belt or Shoulder Belt Mounted on Door

Belts Forward of the Seat Bight

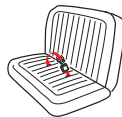

Some vehicles you may not get a secure fit. Read both your vehicle and car seat manuals.

Lap/Shoulder Belt Installation - Rear-Facing/Forward Facing Modes

Always review your vehicle owner's manual for specific information about your vehicle seat belts.

Most vehicles manufactured after 1996 will have Switchable retractors in the back seat. If you have any questions about your retractor type, consult your vehicle owner's manual, call Graco or visit www.gracobaby.com/vehicle-seatbelt-information.

To verify you have a Switchable retractor, **slowly** pull the belt all the way out, and then allow it to retract several inches. Try to pull the belt all the way out again. If it cannot be pulled out, it is **Switchable** retractor. Follow the steps in the rear-facing/forward-facing sections in this manual.

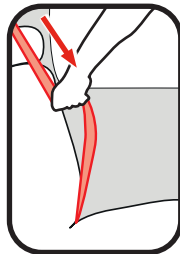

11-A Cleaning Seat Insert

Refer to care tag for washing instructions.

Seat Insert

Clean with a damp sponge using mild soap and cool water.

To remove pad, on each side, remove the pin from the seat on each side of the support.

You must remove the plastic blocks from the side panels. To remove, open the pockets and remove the plastic block pieces.

Reverse the steps to insert the plastic block pieces and re-attach seat insert.

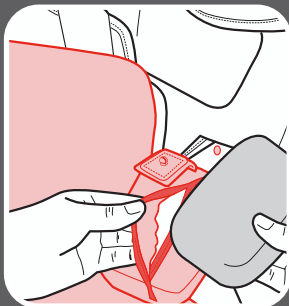
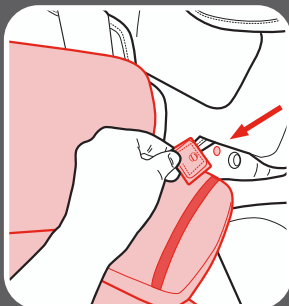

11
Care &
Cleaning

11-B Cleaning Rapid Remove Seat Pad

Refer to seat pad care tag for washing instructions.

Headrest Pad

Clean with a damp sponge using mild soap and cool water. If needed, pad may be removed for cleaning.

Undo the 2 elastic straps from the back of headrest and remove the pad.

Slide the elastic retaining loops out of the belts guides.

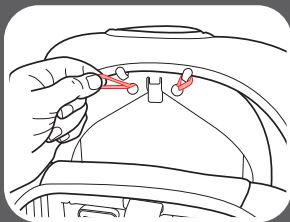

Remove the upper part of the headrest pad from around the headrest.

Carefully slide the pad off the headrest-bumpers.

Machine wash pad in cold water on delicate cycle and drip-dry. **DO NOT USE BLEACH.**
Reverse the steps to reattach the pad on the headrest.

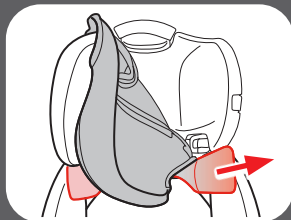
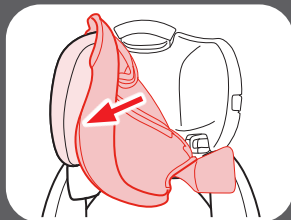



11 Care & Cleaning

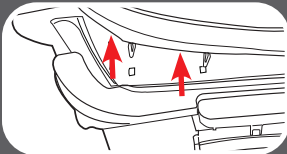
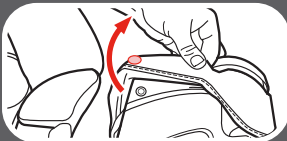
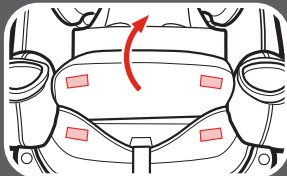
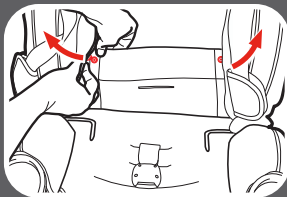

Seat Pad

Clean with a damp sponge using mild soap and cool water. If needed, cover may be removed for cleaning.

To remove unsnap seat pad from side pad. Undo the seat pad from the fastening strips on both sides.

Machine wash pad in cold water on delicate cycle and drip-dry. **DO NOT USE BLEACH.**

Reverse the steps to reattach the pad to the shell.

Front Seat Pad

Clean with a damp sponge using mild soap and cool water. If needed, cover may be removed for cleaning.

Unsnap front seat pad from plastic shell. Pull the arm rest pads over the cup holders. Remove the front retainers by pulling the front end of the pad away from the seat. Remove the retainers from the pad before machine washing.

Machine wash pad in cold water on delicate cycle and drip-dry. **DO NOT USE BLEACH.**

Reverse the steps to reattach the pad to the shell.

Side Pad

Clean with a damp sponge using mild soap and cool water. If needed, pad may be removed for cleaning.

From the back of the seat, undo the 2 fastening strips at the top of the side pads.

Pull the side pads from the shell.

Machine wash pad in cold water on delicate cycle and drip-dry. **DO NOT USE BLEACH.**

Reverse the steps to reattach the pad to the shell.

Top Pad

Clean with a damp sponge using mild soap and cool water. If needed, pad may be removed for cleaning.

From the back of the seat, undo the 2 elastic straps.

Machine wash pad in cold water on delicate cycle and drip-dry. **DO NOT USE BLEACH.**

Reverse the steps to reattach the pad to the shell.

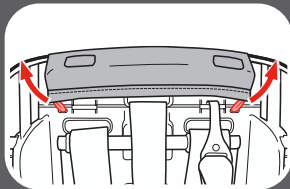
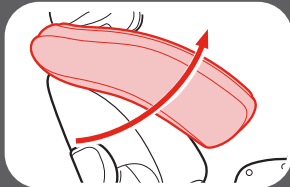
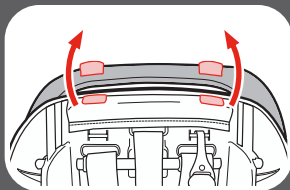



11-C Cleaning Buckle

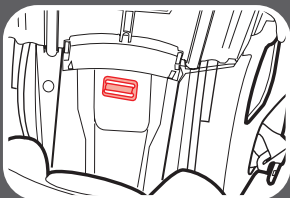

Recline the car seat, extend the footrest, then locate the metal retainer. Rotate the metal retainer up through the shell and pad. From the front, pull the buckle strap out.

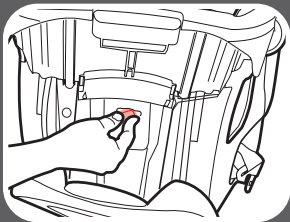

To clean buckle, place in a cup of warm water and gently agitate the buckle. Press the red button several times while in the water.

DO NOT SUBMERGE THE BUCKLE STRAP. DO NOT USE SOAPS, HOUSEHOLD DETERGENTS or LUBRICANTS.



Shake out excess water and allow to air dry. Repeat steps as needed until it fastens with a click. Re-insert the buckle into the same slot it was removed. Pull up on buckle strap to make sure it is secured.

WARNING! Inspect and clean buckle from time to time to remove any objects or debris that could prevent latching.

11-D Cleaning Harness, Lower Anchor Attachment and Tether

Surface wash only with mild soap and damp cloth. **DO NOT IMMERSE THE HARNESS STRAPS, LOWER ANCHOR STRAP, or TETHER STRAP IN WATER.** Doing so may weaken the straps.

If harness straps, lower anchor strap or tether strap are frayed or heavily soiled, contact Customer Service at www.gracobaby.com or 1-800-345-4109.

11-E Cleaning Extend2Fit® Extension Panel

Use only mild soap and water to clean the extension panel.

DO NOT USE BLEACH or other chemicals. Avoid spilling drinks on the extension panel.

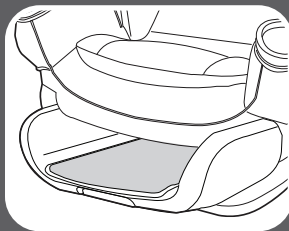

11-F Cleaning Anti-Rebound Bar

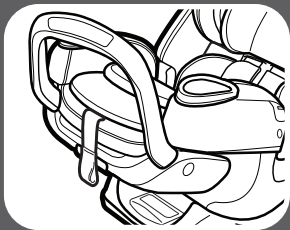

Use only mild soap and water to clean the Anti-Rebound Bar.

DO NOT USE BLEACH or other chemicals. Avoid spilling drinks on the Anti-Rebound Bar.



Notes

Replacement Parts

To purchase parts or accessories in the United States,
please contact us at the following:

www.gracobaby.com

or

1-800-345-4109



Store instruction manual in
the slot with the instruction
book icon as shown.

