

# Oster®



**TSSTTV-ELXLDAF3 MODEL**

EXTRA LARGE DIGITAL AIR FRY OVEN

## INSTRUCTION MANUAL

P.N. ART0000918481  
SAP Number: 2153271



[www.oster.com](http://www.oster.com)

# INTRODUCTION

Congratulations on your purchase of the OSTER® Extra Large Digital Air Fry Oven! If you require service on your OSTER® Countertop Oven, do not return to place of purchase. Please contact us at [www.oster.com](http://www.oster.com) or **1.800.334.0759**.



# IMPORTANT SAFEGUARDS

When using electrical appliances, basic safety precautions should always be followed to reduce the risk of fire, electric shock, and/or injury to persons including the following:

1. Read all instructions before using this product.
2.  This appliance generates heat during use. Do not touch hot surfaces. Use handles or knobs. Always protect your hands with non-slip oven mitts or similar.
3. To protect against electric shock, do not place or immerse cord, plugs, or appliance in water or other liquid.
4. This appliance is not intended for use by children or by persons with reduced physical, sensory, or mental capabilities, or lack of experience and knowledge. Close supervision is necessary when any appliance is used near children. Children should be supervised to ensure that they do not play with the appliance. Keep the appliance and its cord out of reach of children.
5. Unplug from outlet when not in use, before putting on or taking off parts and before cleaning. Allow to cool before putting on or taking off parts, and before cleaning. To disconnect, turn any control to OFF, then unplug power cord from outlet. Do not disconnect by pulling on cord. Always grasp the plug and pull to disconnect.
6. Do not operate any appliance with a damaged cord or plug or after the appliance malfunctions, or has been damaged in any manner. Do not attempt to replace or splice a damaged cord. Return appliance to the manufacturer (see warranty) for examination, repair or adjustment.
7. The use of accessory attachments not recommended by the appliance manufacturer may cause injuries.
8. Do not use outdoors or for commercial purposes.
9. Do not let cord hang over edge of table or counter, or touch hot surfaces.
10. Do not place on or near wet surfaces, or heat sources such as a hot gas or electric burner, or in a heated oven.
11. Extreme caution must be used when moving an appliance or removing a pan, containing hot oil or other hot liquids. Always protect your hands with non-slip oven mitts or similar.
12. Do not use appliance for other than intended use. Misuse can cause injuries. Intended for household countertop use only. Keep 6 inches (152 mm) clear from the wall and on all sides. Always use appliance on a dry, stable, level surface.
13. Oversize foods or metal utensils must not be inserted in a toaster-oven as they may create a fire or risk of electric shock.
14. A fire may occur if the toaster-oven is covered, touching or near flammable materials, including curtains, draperies, towels, walls, and the like, when in operation. Do not store any item on top of the appliance when in operation.
15. Do not clean with metal scouring pads. Pieces can break off the pad and touch electrical parts, creating a risk of electric shock.

## IMPORTANT SAFEGUARDS (CONT.)

16. Extreme caution should be exercised when using containers constructed of materials other than metal or glass.
17. Do not store any materials, other than manufacturers recommended accessories, in this oven when not in use.
18. Do not place any of the following materials in the oven: paper, cardboard, plastic, or any materials that may catch fire or melt.
19. Do not cover crumb tray or any part of the oven with metal foil. This will cause overheating of the oven.
20. Empty the crumb tray after each use.
21. The glass door is made of tempered glass. Always inspect the glass door for chips, cracks or any other damage. Do not use the toaster oven if the glass door is damaged, as the glass may shatter during use.
22. If your toaster oven is equipped with a STAY-ON feature, toaster oven will stay ON if knob is turned counter-clockwise past zero. Exercise caution when using this feature and do not operate unattended for long periods.
23. Do not use with a programmer, timer, wireless plug adapter or outlet that allows control remotely, or connect to a circuit that is regularly switched on and off by the utility.

## SAVE THESE INSTRUCTIONS HOUSEHOLD USE ONLY

North American models with polarized plugs:

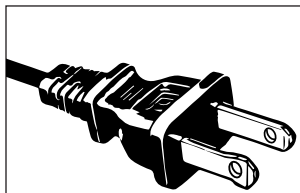

### Polarized plug

This appliance has a polarized plug, (one blade is wider than the other). As a safety feature to reduce the risk of electrical shock, this plug is intended to fit in a polarized outlet only one way. If the plug does not fit fully in the outlet, reverse the plug. If it still does not fit, contact a qualified electrician. Do not attempt to defeat this safety feature or modify the plug in any way. If the plug fits loosely into the AC outlet or if the AC outlet feels warm do not use that outlet.

## POWER CORD INSTRUCTIONS

A short power-supply cord or detachable power-supply cord is provided to reduce risks resulting from becoming entangled in or tripping over a longer cord. Longer detachable power-supply cords or extension cords are available and may be used if care is exercised in their use. If a long detachable power-supply cord or extension cord is used:

- a. The marked electrical rating of the cord set or extension cord should be at least as great as the electrical rating of the appliance;
- b. The cord should be arranged so that it will not drape over the countertop or tabletop where it can be pulled on by children or tripped over unintentionally; and
- c. If the appliance is of the grounded type, the cord set or extension cord should be a grounding-type 3-wire cord.

Do not pull, twist or otherwise abuse the power cord.

## PRODUCT NOTICES

1. Some countertop and table surfaces are not designed to withstand the prolonged heat generated by certain appliances. Do not set the heated unit on a finished wood table. We recommend placing a hot pad or trivet under your countertop oven to prevent possible damage to the surface.
2. During initial use of this appliance, some slight smoke and/or odor may be detected. This is normal with many heating appliances and will not recur after a few uses.

# GET TO KNOW YOUR OVEN

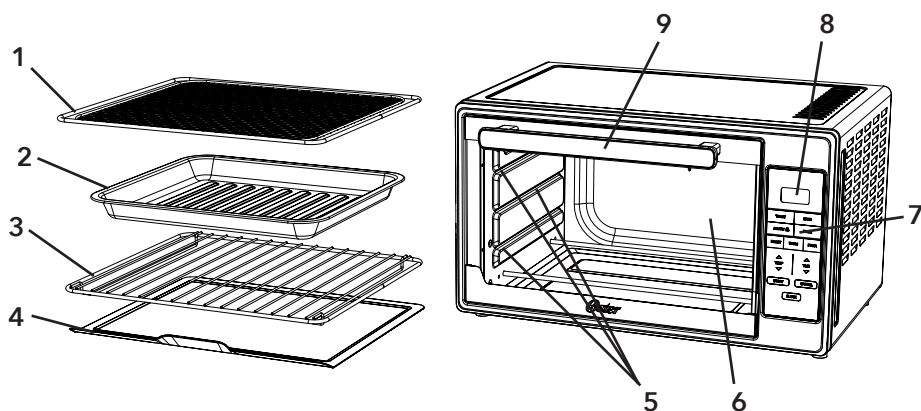

1. Air Fry Rack
2. Baking Pan
3. Wire Rack / Broil Rack
4. Crumb Tray / Cookie Sheet
5. Three Rack Positions
6. Glass Door
7. Control Buttons
8. Time Display
9. Handle

**NOTE:** Accessories included are dependent of model purchased.

# GETTING STARTED

## Preparing To Use Your Countertop Oven for the First Time

If you are using your countertop oven for the first time, please be sure to:

1. Remove any stickers from the surface of the oven.
2. Open oven door and remove all printed documents and paper from inside the countertop oven.
3. Clean the air fry rack, wire rack, baking pan, and removable crumb tray with hot water, a small amount of dishwashing liquid and a non-abrasive sponge or cleaning pad.

**CAUTION:** DO NOT IMMERSE THE BODY OF THE UNIT IN WATER.















4. Dry the unit thoroughly before using.
5. Select a location for the countertop oven. The location should be in an open area on a flat counter where the plug will reach an outlet.
6. Plug the countertop oven into a 120 Volt AC electrical outlet.

**NOTE:** It is recommended that the countertop oven heat at 450° for approximately 15 minutes to eliminate any manufacturing residue that may remain after shipping.

## SETTING THE CLOCK

1. Push the Clock button. The clock will flash.
2. Use the arrow keys to set the hour. Push the Clock button again.
3. Use the arrow keys to set the minutes.
4. Push the Clock button once more and the time will be set.

# OVEN FUNCTIONS OVERVIEW

Preset	Best For:	Preheat	Accessory	Rack Position
Bake		Yes		Middle
Toast		No		Middle
Broil		No		Top
Warm		No		Bottom
Air Fry		Yes		Middle
Roast		Yes		Bottom
Pizza		Yes		Middle

# USING YOUR OVEN

## To Open the Oven Door:

**Step 1:** Grab the center of the handle underhanded with fingertips (See Figure 1).

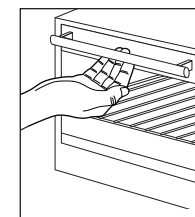

Figure 1

**Step 2:** Pull down the oven door carefully (See Figure 2).

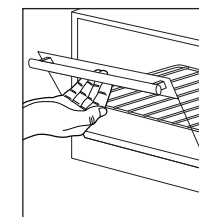

Figure 2

**CAUTION:** This appliance generates heat during use. Do not touch hot surfaces. Always use handles or knobs per above instructions.

## To Preheat the Oven

1. Place oven rack into the desired position before heating the oven.
2. Select desired cooking function.
3. Use the temp arrow keys to select the desired temperature.
4. Use the timer arrow keys to select the desired time.
5. Select the start button.

**NOTE:** While preheating, the display will show PrE. When the oven reaches the desired temperature, it will beep. Press the start button to begin the cooking process.

This oven has a preheat feature in Bake, Air Fry, Pizza, and Roast. To bypass the preheat function press the start button a second time.

## To Use the Bake, Air Fry, Broil, Roast, Pizza, or Warm Functions

1. Select desired oven rack position. (See "Oven Functions Overview" Section).
2. Arrange food on the Wire Rack, Air Fry Rack, Baking Pan, or in the Cookie Sheet.  
**NOTE:** When air frying foods with high amounts of fat or grease, it is recommended to place the Wire Rack, with Baking Pan on top, in the bottom rack position to catch drippings during the cooking cycle.
3. Select the desired cooking function.
4. Use the temperature arrow keys to select desired temperature and the time arrow keys to select desired time.
5. Select the Start button.

When cooking is completed, open door fully and remove food carefully.

**WARNING:** Cooked food can be very hot. Handle with care. Do not leave countertop oven unattended.

## To Use the Toast Function

1. Place Wire Rack into the middle rack position before heating the oven.  
**NOTE:** Different types of bread require different settings. Lighter breads and waffles require a lighter setting. Darker breads, muffins, and English muffins require a darker setting.
2. Select the Toast button.
3. Use the time arrows to select the Toast Shade.
4. Press the Start button.

When toasting is completed, open door fully and remove food carefully.

**WARNING:** Cooked food can be very hot. Handle with care. Do not leave countertop oven unattended.

## AIR FRY CHART

Food	Weight	Function	Temperature (°F)	Time	Oil?
<b>Potatoes</b>					
Hand-Cut Fries	2 lbs	AIR FRY	425 degrees	20-22 min	Yes
Hand-Cut Sweet Potato Fries	2 lbs	AIR FRY	425 degrees	19-21 min	Yes
Frozen Fries (Thick Cut)	1.5 lbs	AIR FRY	450 degrees	10-13 min	No
Frozen Fries (Thin Cut)	1.5 lbs	AIR FRY	450 degrees	10-12 min	No
<b>Meat/Poultry/Seafood</b>					
Chicken Wings	2 lbs	AIR FRY	400 degrees	35 min	No
Chicken Breast Cutlet	2.5 lbs	AIR FRY	450 degrees	27-30 min	Yes
Chicken Tenderloin	1.5 lbs	AIR FRY	400 degrees	25-30 min	Yes
Hamburger	1.5 lbs	AIR FRY	450 degrees	18-22 min	No
Pork Chops	4 lbs	AIR FRY	450 degrees	20-25 min	Yes
Breaded Fish	1 lb	AIR FRY	425 degrees	18-22 min	Yes
<b>Frozen Snacks</b>					
Frozen Chicken Nuggets	1.5 lbs	AIR FRY	450 degrees	15-18 min	No
Frozen Chicken Fingers	1.5 lbs	AIR FRY	425 degrees	18-20 min	No
Frozen Mozzarella Sticks	1.5 lbs	AIR FRY	425 degrees	8-10 min	No
Frozen Onion Rings	1 lb	AIR FRY	425 degrees	7-8 min	No
Frozen Mixed Vegetables	1.5 lbs	AIR FRY	450 degrees	35-40 min	Yes
<b>Fresh Vegetables</b>					
Broccoli	2 lbs	AIR FRY	425 degrees	18-24 min	Yes
Asparagus	2 lbs	AIR FRY	425 degrees	18-24 min	Yes
Brussels Sprouts	2 lbs	AIR FRY	425 degrees	20-25 min	Yes
Carrots	1 lb	AIR FRY	400 degrees	20-25 min	Yes

\*Cook times are estimates and may vary based on food type and preparation.

**Note:** Not all foods will benefit from being tossed in oil prior to being air fried. Frozen foods and foods with a high fat content such as chicken wings or bacon do not require oil. To achieve crispy and browned results on foods such as hand-cut fries or vegetables, evenly coat food with about one tablespoon of oil.

## POSITIONING

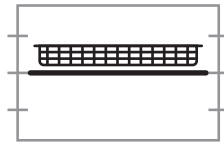

*Baking pan on top of the wire rack*



*Baking pan in guide rails below wire rack*

The baking pan can be placed on top of the rack or inserted into the guide rails below the rack.

Before removing the baking pan allow the unit to cool.

Positioning of the baking pan will depend on the desired cooking method. For baking, place the baking pan on top of one of the racks. For broiling, insert the baking pan into the guide rails below the rack and place the food on top of the rack.

**PLEASE NOTE:** Do not use the baking pan under the wire rack in the lower position.

### Pan Position

## CARE AND CLEANING

### Cleaning Your Countertop Oven

Before cleaning your OSTER® Countertop Oven, unplug it and allow it to cool. To clean, wipe with damp cloth.

**CAUTION:** DO NOT IMMERSE IN WATER!

Make sure to use only mild, soapy water. Clean the air fry rack, baking pan, wire rack, and removable crumb tray with hot water, a small amount of dishwashing liquid and a non-abrasive sponge or cleaning pad. Abrasive cleaners, scrubbing brushes and chemical cleaners will damage the coating on this unit. Empty crumb tray frequently to avoid accumulation of crumbs.

This appliance has no user serviceable parts. Any servicing beyond that described in the Cleaning Section should be performed by an Authorized Service Representative only. See Warranty Section.

### Storing Your Countertop Oven

Allow the appliance to cool completely before storing. If storing the countertop oven for long periods of time make certain that the countertop oven is clean and free of food particles. Store the countertop oven in a dry location such as on a table or countertop or cupboard shelf. Other than the recommended cleaning, no further user maintenance should be necessary.

# HELPFUL TIPS / TROUBLESHOOTING

Problem	Potential Cause	Solution
<ul style="list-style-type: none"> <li>Overcooked / Undercooked Foods</li> </ul>	<ul style="list-style-type: none"> <li>Incorrect temperature or time setting</li> <li>Rack placement</li> </ul>	<ul style="list-style-type: none"> <li>You may have to adjust the time and temperature to desired taste.</li> <li>Because your countertop oven is smaller than your regular oven, it will heat up faster and generally cook in shorter periods of time.</li> <li>Refer to "Oven Functions Overview" section, page 8. Rack may need to be adjusted to accommodate food type.</li> </ul>
<ul style="list-style-type: none"> <li>Burnt Smell</li> </ul>	<ul style="list-style-type: none"> <li>Food build-up inside oven, on heating elements or in crumb tray.</li> </ul>	<ul style="list-style-type: none"> <li>Refer to "Cleaning you Countertop Oven" Section, page 13.</li> </ul>
<ul style="list-style-type: none"> <li>Oven does not turn ON</li> </ul>	<ul style="list-style-type: none"> <li>Unit is unplugged</li> <li>Did not press start.</li> </ul>	<ul style="list-style-type: none"> <li>Plug the countertop oven into a 120-volt AC electrical outlet.</li> <li>Set timer and temperature to desired setting. Both must be turned on to operate the countertop oven.</li> <li>Press Start.</li> </ul>
<ul style="list-style-type: none"> <li>Only one heating element is heating up</li> </ul>	<ul style="list-style-type: none"> <li>Function setting selection determines which heating element will operate.</li> </ul>	<ul style="list-style-type: none"> <li>When toasting, make sure the oven is <b>not</b> set to broil setting.</li> </ul>
<ul style="list-style-type: none"> <li>Heating elements do not stay ON</li> </ul>	<ul style="list-style-type: none"> <li>Heating elements will cycle ON and OFF to maintain proper heat.</li> </ul>	<ul style="list-style-type: none"> <li>Be certain that function is as desired.</li> <li>Heating elements may not glow.</li> </ul>
<ul style="list-style-type: none"> <li>Cannot change function button</li> </ul>	<ul style="list-style-type: none"> <li>Need to cancel function.</li> </ul>	<ul style="list-style-type: none"> <li>Press cancel.</li> </ul>

# 1 YEAR SATISFACTION GUARANTEED

Sunbeam Products, Inc., (collectively "Sunbeam") warrants that for a period of one year from the date of purchase, this product will be free from defects in material and workmanship. Sunbeam, at its option, will repair or replace this product or any component of the product found to be defective during the guarantee period. Replacement will be made with a new or remanufactured product or component. If the product is no longer available, replacement may be made with a similar product of equal or greater value. This is your exclusive guarantee. Do NOT attempt to repair or adjust any electrical or mechanical functions on this product. Doing so will void this guarantee. This guarantee is valid for the original retail purchaser from the date of initial retail purchase and is not transferable. Keep the original sales receipt. Proof of purchase is required to obtain satisfaction guarantee performance. Sunbeam dealers, service centers, or retail stores selling Sunbeam products do not have the right to alter, modify or any way change the terms and conditions of this guarantee.

This guarantee does not cover damage resulting from any of the following: negligent use or misuse of the product, use on improper voltage or current, use contrary to the operating instructions, disassembly, repair or alteration by anyone other than Sunbeam or an authorized Sunbeam service center. Further, the guarantee does not cover: Acts of God, such as fire, flood, hurricanes and tornadoes.

## What are the limits on Sunbeam's Liability?

Sunbeam shall not be liable for any incidental or consequential damages caused by the breach of any express, implied or statutory guarantee or condition. Except to the extent prohibited by applicable law, any implied guarantee or condition of merchantability or fitness for a particular purpose is limited in duration to the duration of the above guarantee. Sunbeam disclaims all other guarantees, conditions or representations, express, implied, statutory or otherwise. Sunbeam shall not be liable for any damages of any kind resulting from the purchase, use or misuse of, or inability to use the product including incidental, special, consequential or similar damages or loss of profits, or for any breach of contract, fundamental or otherwise, or for any claim brought against purchaser by any other party.



Some provinces, states or jurisdictions do not allow the exclusion or limitation of incidental or consequential damages or limitations on how long an implied guarantee lasts, so the above limitations or exclusion may not apply to you. This guarantee gives you specific legal rights, and you may also have other rights that vary from province to province, state to state or jurisdiction to jurisdiction.

## **How to Obtain Satisfaction Guarantee Service**

In the U.S.A. If you have any question regarding this guarantee or would like to obtain guarantee service, please call **1-800-334-0759** and a convenient service center address will be provided to you.

In the U.S.A., this guarantee is offered by Sunbeam Products, Inc., located in Boca Raton, Florida 33431. If you have any other problem or claim in connection with this product, please write to the Consumer Service Department.

PLEASE DO NOT RETURN THIS PRODUCT TO ANY OF THESE ADDRESSES OR TO THE PLACE OF PURCHASE.



# *Oster*<sup>®</sup>

For product questions contact: Sunbeam Consumer Service  
USA: **1.800.334.0759** - [www.oster.com](http://www.oster.com)

© 2021 Sunbeam Products, Inc. All rights reserved. Distributed by Sunbeam Products, Inc., Boca Raton, Florida 33431. Printed in China.

TSSTTV-ELXLDAF3\_21EM1 (US)

GCDS-OST-JC