

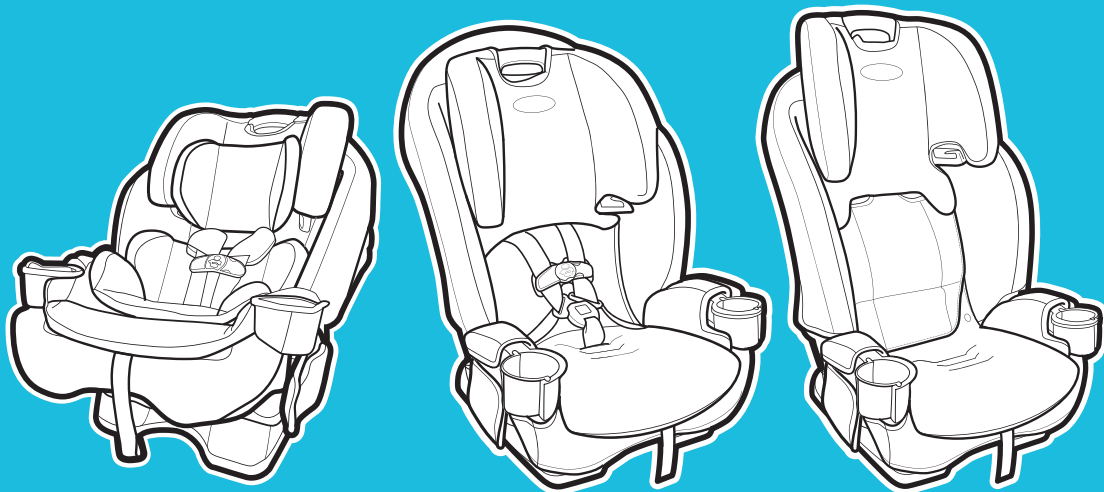

SLIMFIT[®] LX

3-IN-1 CAR SEAT

Read This Instruction Manual



Do not install or use this child restraint until you read and understand the instructions in this manual.

FAILURE TO PROPERLY USE THIS CHILD RESTRAINT INCREASES THE RISK OF SERIOUS INJURY OR DEATH IN A SUDDEN STOP OR CRASH.



Scan the code or visit
www.gracobaby.com to
view installation videos.

1 Important

Pages 4-8

- 1-A Welcome to the Graco Family!**
If You Need Help
- 1-B Quick Guide to Your Manual**
Register This Child Restraint
- 1-C Safety Warnings**
Car Seat's Useful Life
Warm Weather Use
- 1-D Right Mode of Use**
- 1-E Aircraft Installation**

2 Features

Pages 9-10

3 Rear-Facing

Pages 11-17

- 3-A Rear-Facing Use**
- 3-B Install Rear-Facing With Lower Anchor Attachment**
- 3-C Install Rear-Facing With Vehicle Seat Belt**

4 Forward-Facing

Pages 18-24

- 4-A Forward-Facing Use**
- 4-B Install Forward-Facing With LATCH**
- 4-C Install Forward-Facing With Vehicle Seat Belt**

5 Booster Use

Pages 25-30

- 5-A Booster Use**
- 5-B Install Highback Booster**

6 Securing Child

Pages 31-36

- 6-A Securing Child 5-point Harness**
- 6-B Securing Child Highback Booster**

7 Moving Lower Anchor Attachment

Pages 37-39

8 Accessories

Pages 40-42

9 Vehicle Information

Pages 43-46

- 9-A How to Uninstall Lower Anchor Connectors and Tether**
- 9-B Choosing Vehicle Seat Location**
- 9-C Which Installation Method Should I Use?**
- 9-D Unsafe Vehicle Seat Locations**
- 9-E Vehicle Seat Belts**

10 Care & Cleaning

Pages 47-51

- 10-A Cleaning RapidRemove™ Seat Pad and MyPocket™ Storage Pockets**
- 10-B Cleaning Crotch Buckle**
- 10-C Cleaning Harness, Lower Anchor and Tether Straps**



1 Important

1-A Welcome to the Graco Family!

Your child's safety depends on you. **No car seat can guarantee protection from injury in every situation, but proper use helps reduce the risk of serious injury or death. READ THIS MANUAL CAREFULLY.**

This child restraint meets or exceeds all applicable requirements of Federal motor vehicle safety standard 213 for use in motor vehicles.

Even if this car seat seems easy to figure out on your own, you must follow the detailed instructions in this instruction manual to ensure the steps are performed correctly.

If You Need Help

In the U.S.A, please contact our Customer Service Department with any questions you may have concerning parts, use, or maintenance. When you contact us, please have your product's model number and date of manufacture ready so that we may help you efficiently. These numbers can be found on a sticker on the back side of your car seat.

Contact us at www.gracobaby.com or call **1-800-345-4109**.

For additional resources or to get your car seat checked by a child passenger safety technician, please visit the following web sites:

www.nhtsa.gov • www.seatcheck.org • www.safekids.org • www.cpsc.gov

1-B Quick Guide to Your Manual

This car seat is for children: *Rear-Facing: 5-40 lb (2.2-18 kg), 49" (125 cm) or less.*

Forward-Facing: 26.5-65 lb (12-30 kg), 49" (125 cm) or less.

Booster: 40-100 lb (18.1-45 kg), 43-57" (110.1-145 cm), and at least 4 years old.

- Children less than 26.5 lb (12 kg) **MUST** use this car seat rear-facing. Review section 1-C for more information.

Note: Preterm or low birth weight infants may be at special risk in a vehicle or aircraft. According to the AAP, these infants may suffer breathing issues if improperly reclined in a car seat. When rear-facing, use the corrected age for preemies. Graco advises that you have your physician or hospital staff evaluate your infant and recommend the proper car seat or car bed before you and your infant leave the hospital.

Register This Child Restraint

Please fill out the prepaid registration postcard attached to the harness and mail it in today **or register online at www.gracobaby.com/carseatregistration.**

Child restraints could be recalled for safety reasons. You must register this restraint to be reached in a recall. Send your name, address, and the restraint's model number and manufacturing date to:

Graco Children's Products, Inc.
Attn: Customer Service
P.O. Box 169, Elverson, PA 19520-9901
or call 1-800-345-4109
or register online at
www.gracobaby.com/carseatregistration

For recall information, call the U.S. Government's Vehicle Safety Hotline at 1-888-327-4236 (TTY: 1-800-424-9153), or go to <http://www.NHTSA.gov>.

For future reference or if you change addresses, record the model name, model number, date of manufacture, and purchase date of this car seat below. You can find this information either on the registration card if you still have it or on the date label located on the back of the car seat.

Model Name _____
Model Number _____
Date of Manufacture _____
Date of Purchase _____

1-C Safety Warnings

WARNING!

Failure to follow these instructions and child restraint's labels can result in child striking the vehicle's interior during a sudden stop or crash.



! NEVER place this child restraint rear-facing in a vehicle seating location that has an active front air bag.

If an air bag inflates, it can hit the child and car seat with great force and cause serious injury or death to your child.

! Review your vehicle owner's manual for more information about air bags and car seat use.

! According to accident statistics, children are safer when properly restrained in the rear seating positions than in the front seating positions. The center of the back seat can be the safest during a possible side impact.

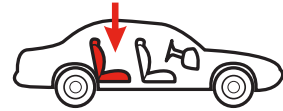

! If your vehicle does not have a back seat, review your vehicle owner's manual.

! Children are safer riding rear-facing and should ride rear-facing as long as possible, until they reach the maximum rear-facing height or weight rating for their car seat. Then children should ride forward-facing, using the built-in harness system for as long as possible until they reach the maximum forward-facing weight or height for their car seat. At that point, children should ride in a belt-positioning booster seat. A booster is no longer needed once the vehicle seat belt fits properly, typically when they reach 4 feet 9 inches (145 cm) tall and are between ages 8-12. Be sure to check your local and state laws, as well as AAP and NHTSA recommendations, for car seat usage.*

! Choose the correct mode of use for the car seat depending on your child's size. Infants less than 26.5 lb (12 kg) **MUST** use this car seat rear-facing.

! Select a suitable location for the car seat in your vehicle.

! Secure car seat with a vehicle seat belt or lower anchor attachment that is properly routed as shown in this manual.

! Vehicle seat belt system **MUST** hold car seat securely. Not all vehicle seat belts can be used with a car seat.

! If vehicle seat belt does not hold car seat securely, read "Vehicle Seat Belts" section 9-E and your vehicle owner's manual.

! Always secure car seat with lower anchor attachment or a vehicle seat belt, even when unoccupied. In a crash, an unsecured car seat can injure passengers.

! If car seat is in a crash, it must be replaced. **DO NOT** use it again! A crash can cause unseen damage and using it again could result in serious injury or death.

! DO NOT use car seat if it is damaged or missing parts.

! DO NOT use accessories or parts other than those provided by Graco except for a thin towel or mat to protect your vehicle seat or a rolled towels or pool noodles to help get your car seat level. Their use could alter the performance of the car seat.

! DO NOT remove LATCH system from car seat. If using vehicle seat belt to secure car seat, lower anchor connectors must be stored.

! Never leave child unattended, even when sleeping. Child may become tangled in harness straps and suffocate or strangle.

! Rear-facing car seat must be properly leveled:

- Too reclined can result in injury or ejection.
- Too upright can result in breathing difficulties.



! Never attach two lower anchor connectors to one vehicle lower anchor point unless specifically allowed by the vehicle manufacturer.

! Do not use both the vehicle seat belt and lower anchor attachment at the same time when using the car seat with the 5-point harness.

*Graco Supports the American Academy of Pediatrics and National Highway Traffic Safety Administration's Car Seat Guidelines. Visit www.gracobaby.com/en-US/safety for information on car seat usage recommendations.

Car Seat's Useful Life

STOP using this car seat and throw it away 10 years after the date of manufacture. Look for date of manufacture label on back of the car seat.

Graco Children's Products Inc. advises against loaning or passing along a car seat unless you know the complete history of the product. We also advise against purchasing a car seat second hand.

Warm Weather Use

Car seat parts can get very hot in the sun or warm weather. **To avoid burns, always check before putting child in car seat.**



1 Important

1-D Right Mode of Use

5 lb (2.2 kg)	26.5 lb (12 kg)	40 lb (18.1 kg)	65 lb (30 kg)	100 lb (45 kg)
------------------	--------------------	--------------------	------------------	-------------------

Rear-Facing with 5-Point Harness

Must be 49" (125 cm) or less: 5-26.5 lb (2.2-12 kg) and less than 1 year old **MUST** be rear-facing. 26.5-40 lb (12-18 kg) **SHOULD** be rear-facing*.

Forward-Facing with 5-Point Harness

Must be 49" (125 cm) or less: 26.5-40 lb (12-18 kg) and can sit upright unassisted **CAN** be forward-facing. 40-65 lb (18-30 kg) **SHOULD** be forward-facing*.

Booster Mode with Vehicle Lap/Shoulder Seat Belt

Must be 43-57" (110.1-145 cm) and 4+ years old: 40-65 lb (18.1-30 kg) **CAN** be in booster mode. Over 65 lb (30 kg) **MUST** be in booster mode*.

* Check your state laws and the AAP/NHTSA recommendations. See page 6.

1-E Aircraft Installation



This car seat is certified for use in aircraft when using the harness system. Use only on forward-facing aircraft seats. Review section 3-C and section 4-C. Do not use the tether.



This car seat is NOT certified for use in aircraft when used as a booster seat because aircrafts do not have shoulder belts.

Contact the airline for their specific policies.

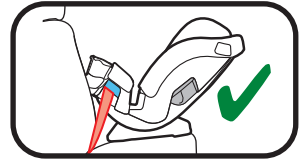

When installing the car seat, route the lap seat belt through the proper path and buckle it in. Then, pull on the tail of the belt so that the lap belt gets tight around the car seat. Review section 3-C and section 4-C. Do not use the tether.

Grab the sides of the seat at the belt path where the lap belt is and move the car seat from side-to-side and front-to-back. If it moves less than 1" (2.5 cm), it is tight enough.

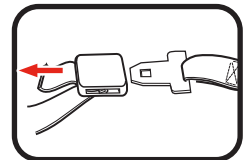

2-A Features

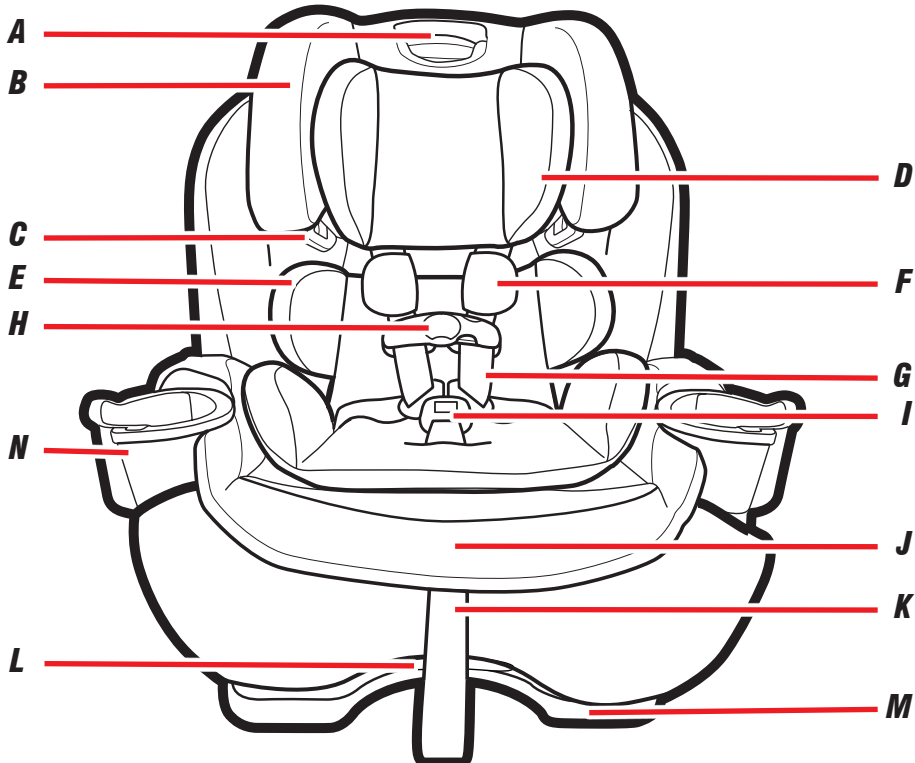

A Headrest/Harness Adjustment Handle

B Headrest

C Booster Shoulder Belt Guide

D Infant Head Support

E Body Support

F Harness Covers

G Harness Straps

H Chest Clip

I Buckle

**J Harness Release Lever
(under flap)**

K Harness Adjustment Strap

L Recline Handle

M Seat Base

N Cup Holder

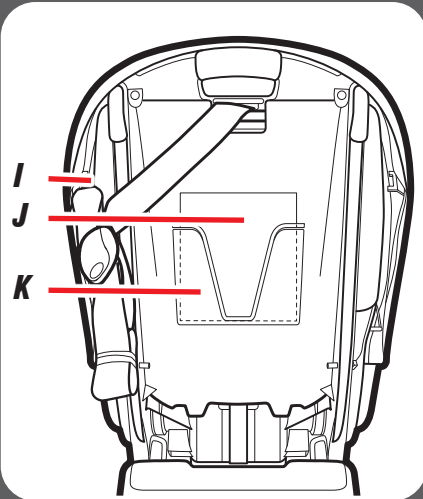
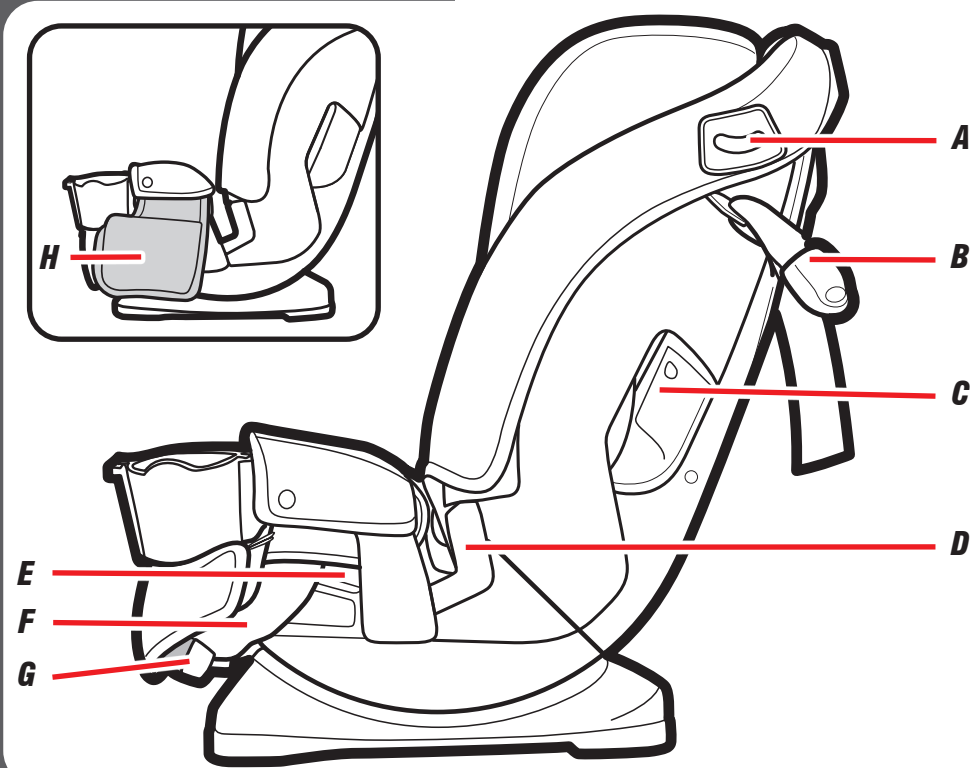

- A** Rear-Facing Level Indicator
- B** Tether
- C** Forward-Facing Belt Path
- D** Booster Lap Belt Path
- E** Rear-Facing Belt Path
- F** Lower Anchor Strap
- G** Lower Anchor Storage
- H** MyPocket™ Storage Pocket
- I** Tether Storage
- J** Instruction Manual
- K** Instruction Manual Storage

3-A Rear-Facing Use

Rear-Facing: 5-40 lb (2.2-18 kg) and 49" (125 cm) or less in height

- Car seat must be rear-facing in the vehicle back seat.
- Make sure lower anchor strap or vehicle seat belt is routed through the rear-facing belt path, marked with a blue label.
- Install this car seat tightly in your vehicle. Car seat **should not move** at the rear-facing belt path more than 1" (2.5 cm) from side to side and front to back.
- Check the rear-facing level indicator to make sure the ball is completely in the blue zone. Vehicle **MUST** be on level ground.
- Harness straps must be **at or just below** the top of child's shoulders and chest clip must be at **armpit level**.
- Infants who weigh less than 26.5 lb (12 kg) **MUST be rear-facing**.
- Children are safer riding rear-facing and should ride rear-facing as long as possible, until they reach the maximum rear-facing height or weight rating for their car seat. Then children should ride forward-facing, using the built-in harness system for as long as possible until they reach the maximum forward-facing weight or height for their car seat. Be sure to check your local and state laws, as well as AAP and NHTSA recommendations, for car seat usage.

⚠ WARNING!



NEVER place this child restraint rear-facing in a vehicle seating location that has an active front air bag.

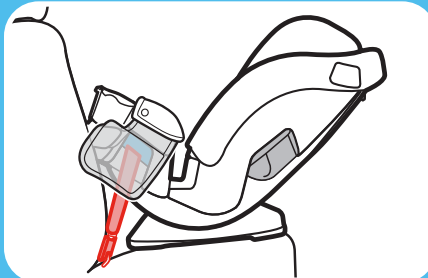

Lower Anchor Attachment

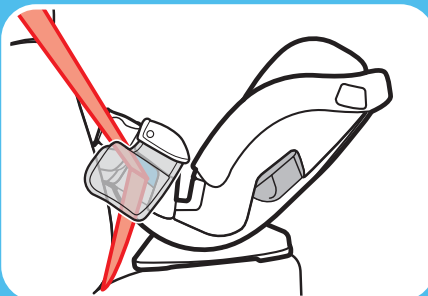

Vehicle Lap/Shoulder Seat Belt

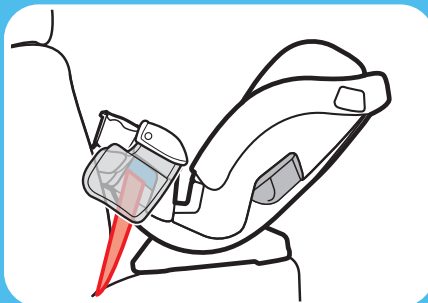

Vehicle Lap Only Seat Belt



3 Rear Facing

3-B Install Rear-Facing With Lower Anchor Attachment

Review your vehicle's owner manual for lower anchor location and use.

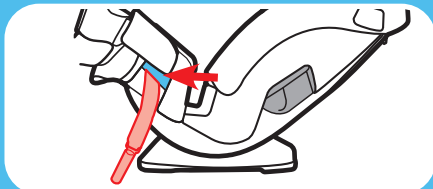

1. **Make Sure Lower Anchor Strap is in the Rear-Facing Belt Path Marked With a Blue Label**

If it is not, see section 7-A to move lower anchor attachment.

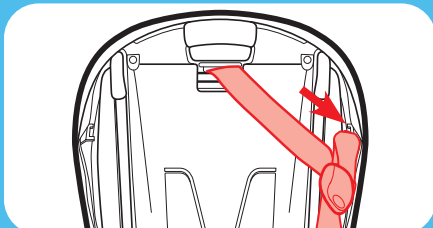

2. **Store Tether Strap**

Attach tether hook to the plastic bar on either side of the car seat.

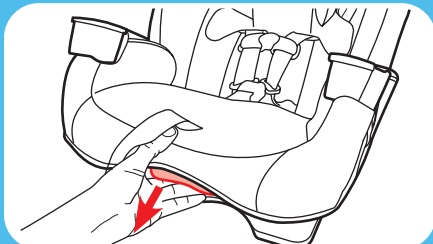

3. **Recline the Car Seat**

Place the car seat in recline position 1 or 2.



4. **Remove Lower Anchor Connectors from Storage Location**

Push in on the red buttons on the lower anchor connectors and remove from storage position.

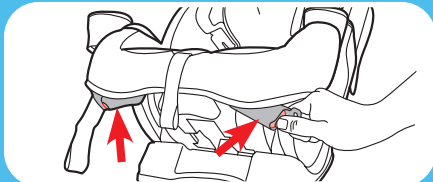

5. **Extend the Lower Anchor Strap**

For easier installation, extend the lower anchor strap to its maximum length by pressing the grey button and pulling on the strap.

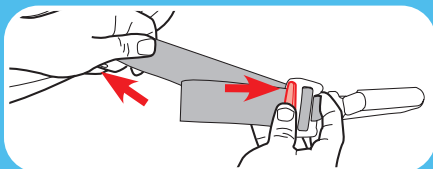

6. Place Car Seat Rear-Facing in Back Seat of the Vehicle

Place rear-facing in vehicle seat and center the car seat between the lower anchors. The base should sit as flat as possible on the vehicle seat.

Make sure base is a minimum of 80% on the vehicle seat.

7. Check the Level Indicator

Vehicle **MUST** be on level ground. **Ball must be completely in the blue zone.** Readjust the incline if needed. Or if needed, rolled towels may be placed under the car seat at the vehicle seat crease, until the ball is completely in the blue zone.

8. Attach Lower Anchor Connectors to Vehicle's Lower Anchors

Lower anchor strap should lie flat and not be twisted. **Lower anchor attachment can ONLY be used if the vehicle lower anchor spacing is 11 inches (28 cm) from the center of one lower anchor to the center of the other lower anchor.**

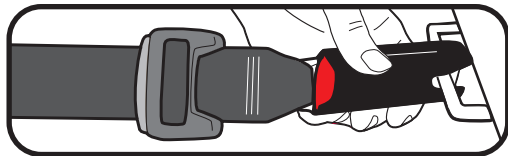

9. Tighten the Lower Anchor Strap

Press down firmly in the center of the car seat while tightening the lower anchor strap.

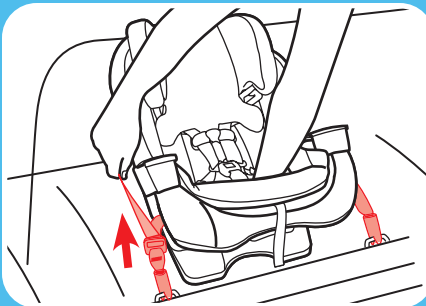
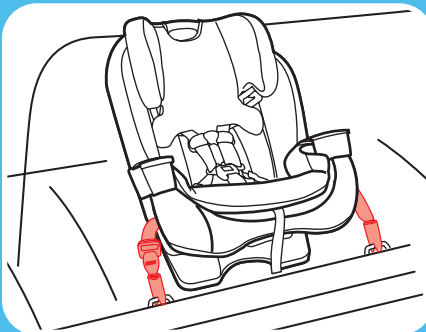
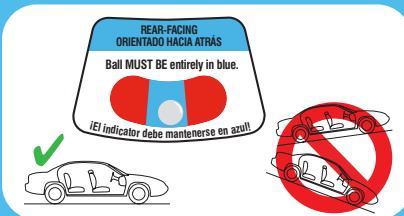
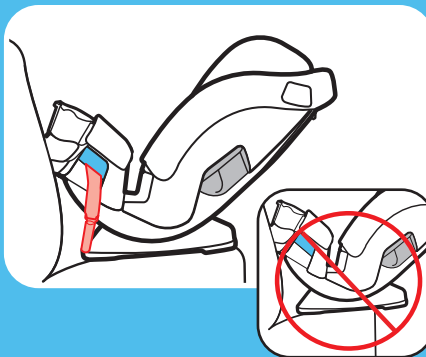

3 Rear Facing

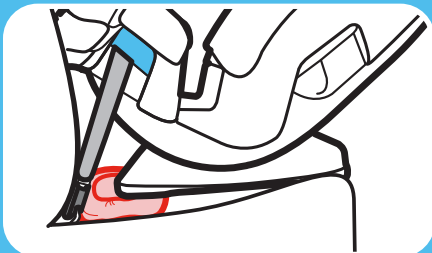
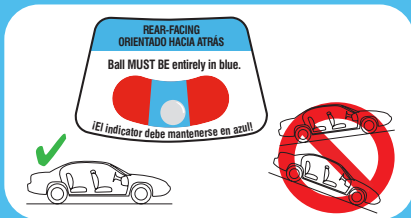
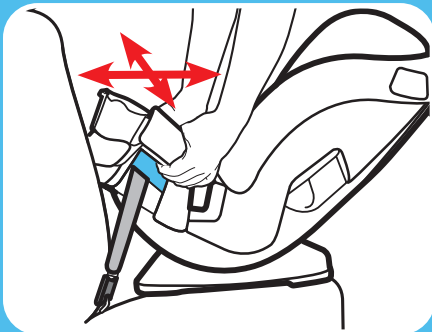
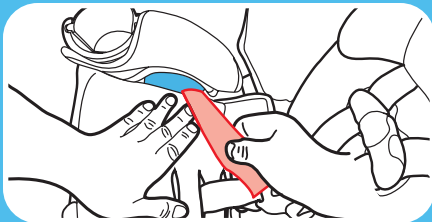

Note: For easier tightening, you may need to pull the tail of the lower anchor strap through the belt path as shown.

10. Test For Tightness

Grab the sides of the seat where the lower anchor strap is and slide the car seat side-to-side and front-to-back.

If the seat moves less than 1" (2.5 cm), it is tight enough.

11. Check the Level Indicator

Vehicle **MUST** be on level ground. **Ball must be completely in the blue zone.**

Readjust the incline if needed. Or if needed, rolled towels may be placed under the car seat at the vehicle seat crease, until the ball is completely in the blue zone.

See section 6-A to secure your child.

Recheck the level indicator with child in seat.

3-C Install Rear-Facing With Vehicle Seat Belt

1. Recline the Car Seat

Place the car seat in recline position 1 or 2.

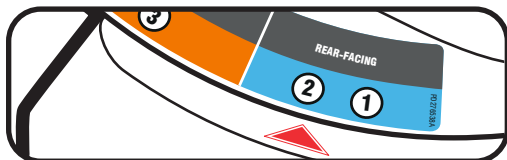

2. Store Tether and Lower Anchor Straps

Attach tether hook and lower anchor connectors to the plastic bars as shown. Remove the slack from both straps.

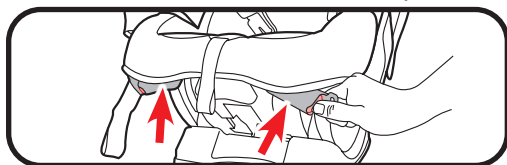

3. Place Car Seat Rear-Facing in Back Seat of the Vehicle

Place the base flat on the vehicle seat. Push it back until the front of the car seat touches the vehicle seat back.

Make sure base is a minimum of 80% on the vehicle seat.

4. Check the Level Indicator

Vehicle **MUST** be on level ground. **Ball must be completely in the blue zone.** Readjust the incline if needed. Or if needed, rolled towels may be placed under the car seat at the vehicle seat crease, until the ball is completely in the blue zone.

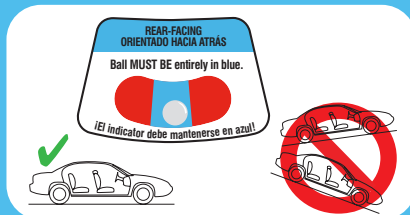
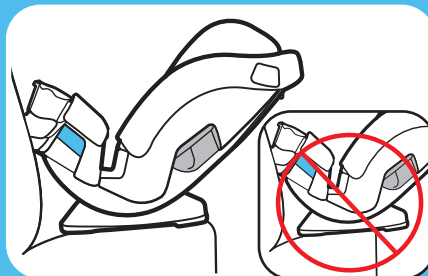
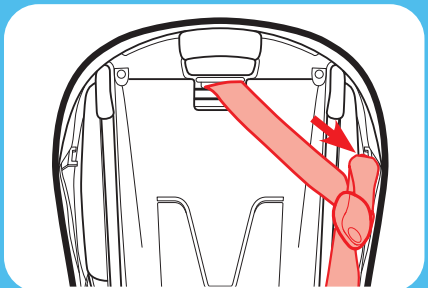
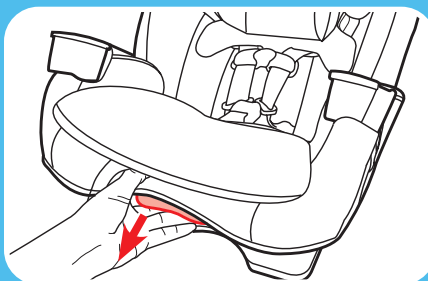

3 Rear Facing

Review your vehicle's owner manual for vehicle seat belt use

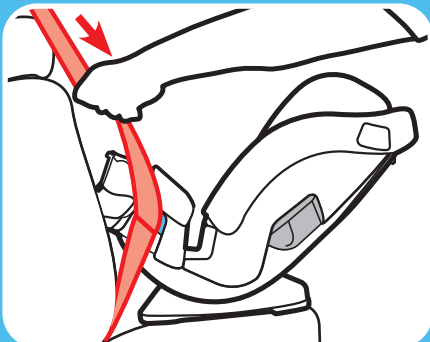
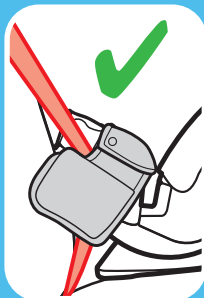
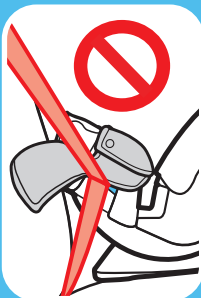
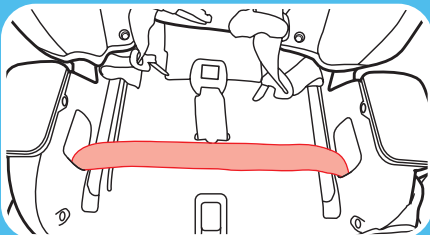
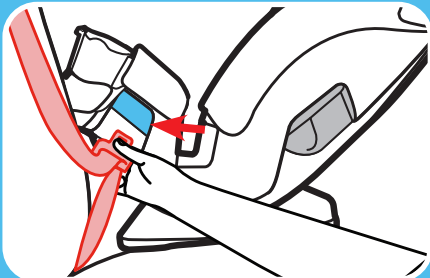

5. Route the Vehicle Seat Belt

Thread vehicle seat belt through the rear-facing belt path (marked with a blue label) and buckle it. The seat belt should lay as flat as possible and not be twisted.

Note: It may be easier to route the vehicle seat belt by lifting seat pad up to expose the belt path.

Make sure vehicle seat belt is in front of the buckle strap.

When using the MyPocket™ Storage Pocket,

When routing the vehicle seat belt, make sure the seat belt is not routed on top of the MyPocket™ Storage Pocket. Flip the pocket up and out of the way when routing the vehicle seat belt.

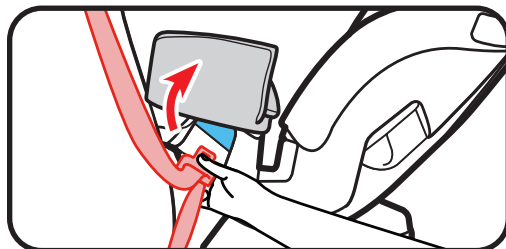

6. Lock the Vehicle Seat Belt

In most vehicles today, slowly pull the shoulder belt all the way out and then let it go back in. You will hear a clicking sound. Slowly pull out on the belt and it should be locked. If not, review your car's owner manual and section 9-E.

3 Rear Facing

7. Tighten the Vehicle Seat Belt

Press down firmly in the center of the car seat. Pull on the shoulder belt to tighten while feeding the slack back in the retractor.



8. Test For Tightness

Grab the sides of the seat where the vehicle seat belt is and slide the car seat side to side and front to back.

If the seat moves less than 1" (2.5 cm), it is tight enough.

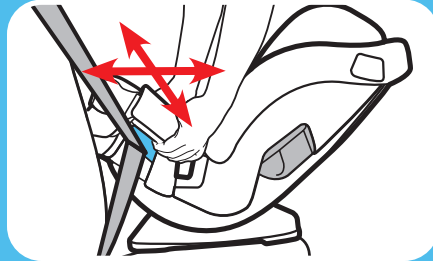

9. Check the Level Indicator

Vehicle **MUST** be on level ground. **Ball must be completely in the blue zone.** Readjust the incline if needed. Or if needed, rolled towels may be placed under the car seat at the vehicle seat crease, until the ball is completely in the blue zone.

See section 6-A to secure your child.

Recheck the level indicator with child in seat.

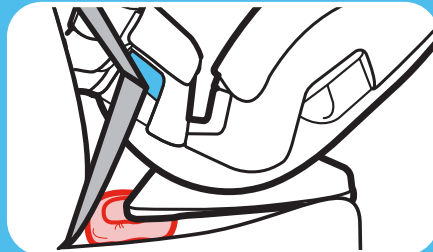
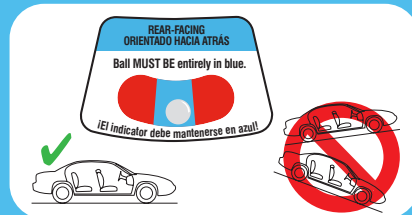

3 Rear Facing

4-A Forward-Facing Use



LATCH

Do not install by this method for a child weighing more than 45 lb (20 kg)

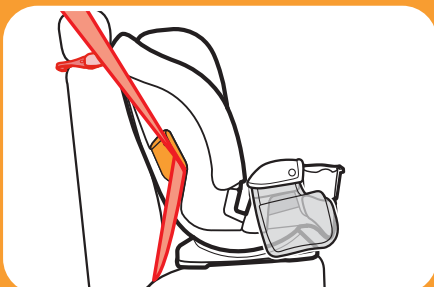

Vehicle Lap/Shoulder Seat Belt with Tether



Vehicle Lap Only Seat Belt with Tether

Forward-Facing:

26.5-65 lb (12-30 kg) and 49" (125 cm) or less

- Car seat must be forward-facing in the vehicle back seat.
- Make sure lower anchor strap or vehicle seat belt is routed through the forward-facing belt path marked with a orange label.
- Install this car seat tightly in your vehicle. Car seat **should not move** at the forward-facing belt path more than 1" (2.5 cm) from side to side and front to back.
- Attach and tighten tether strap.
- Harness straps must be **at or just above** the top of child's shoulders and chest clip must be at **armpit level**.
- Children are safer riding rear-facing and should ride rear-facing as long as possible, until they reach the maximum rear-facing height or weight rating for their car seat. Then children should ride forward-facing, using the built-in harness system for as long as possible until they reach the maximum forward-facing weight or height for their car seat. At that point, children should ride in a belt-positioning booster seat. Be sure to check your local and state laws, as well as AAP and NHTSA recommendations, for car seat usage.

4-B Install Forward-Facing With LATCH

Review your vehicle owner's manual for LATCH location and use. Do not install by this method for a child weighing more than 45 lb (20 kg).

1. Make Sure Lower Anchor Strap is in the Forward-Facing Belt Path Marked with Orange Label

If it is not, see section 7-A.

2. Recline the Car Seat

Place the car seat in recline position 3 or 4.

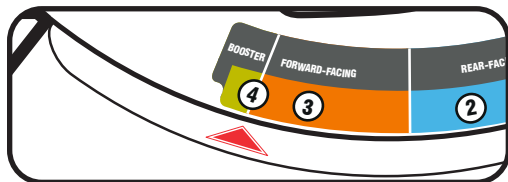

3. Remove Lower Anchor Connectors and Tether from Storage Locations

Push in on the red buttons on the lower anchor connectors and remove from storage position. Unhook tether and lay it in the seat.

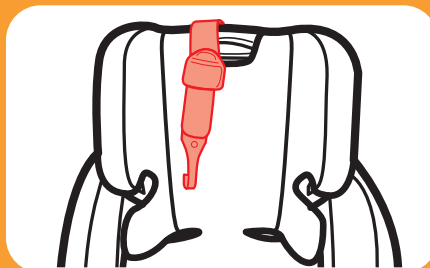
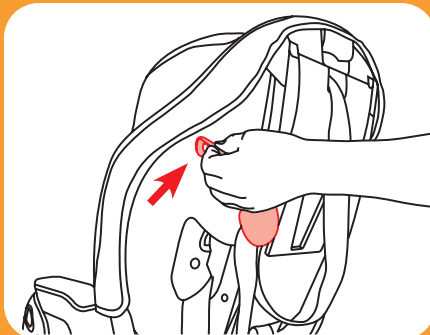
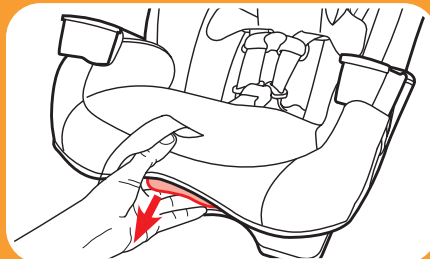
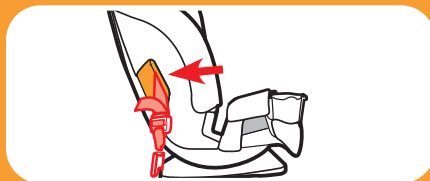
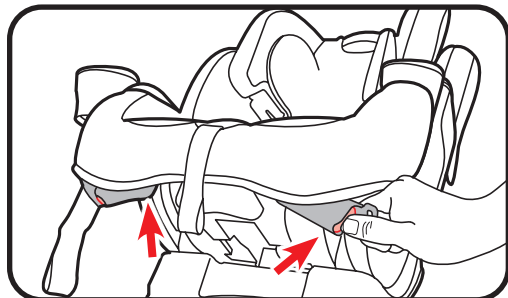

4 Forward Facing

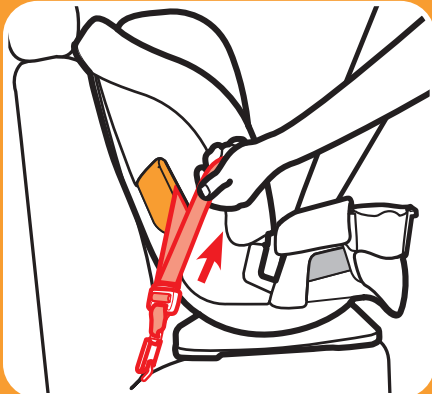
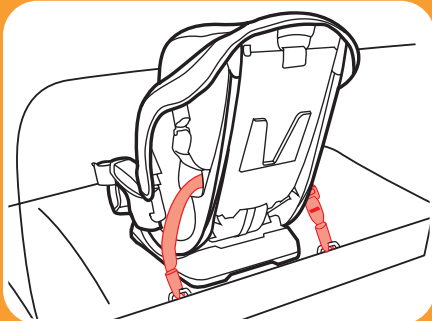
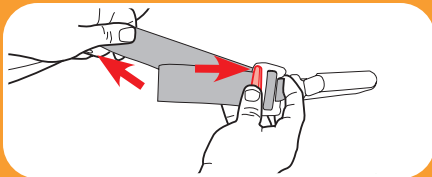

4. **Extend the Lower Anchor Strap**

For easier installation, extend the lower anchor strap to its maximum length by pressing the gray button and pulling out on the strap.

5. **Place Car Seat Forward-Facing in Back Seat of the Vehicle**

Place the base flat on the vehicle seat. Push it back firmly until the back of the car seat touches the vehicle seat back. Center the car seat between the lower anchors.

Make sure base is a minimum of 80% on the vehicle seat.

6. **Attach Lower Anchor Connectors to Vehicle's Lower Anchors**

Lower anchor strap should lay as flat as possible and not be twisted.

Lower anchor attachment can **ONLY** be used if the vehicle lower anchor spacing is 11 inches (28 cm) from the center of one lower anchor to the center of the other lower anchor.

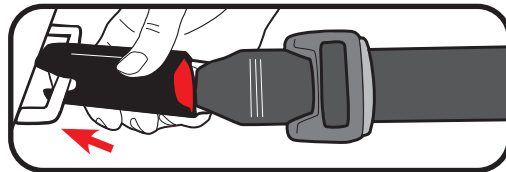

7. **Tighten the Lower Anchor Strap**

Press down firmly in the center of the car seat while tightening the lower anchor strap.

Note: You may need to tighten through the slit in the pad at the belt path as shown.

8. Attach Tether Strap

Extend the tether by lifting up on the tether lock and attach.

Consult vehicle's owner manual for specific location.

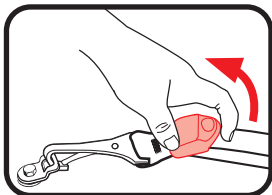

9. Tighten Tether Strap

Remove all the slack.

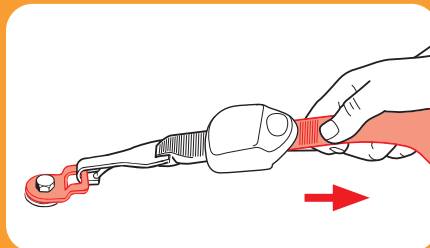
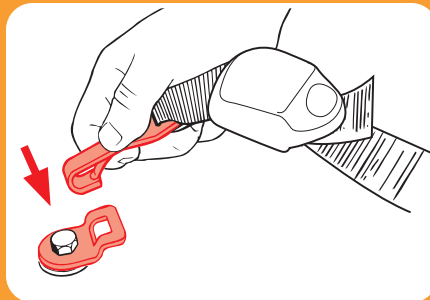
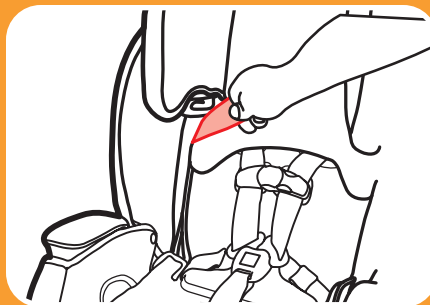

10. Test For Tightness

Grab the sides of the seat where the lower anchor strap is and slide the car seat side to side and front to back.

If the seat moves less than 1" (2.5 cm), it is tight enough.

See section 6-A to secure your child.



4 Forward Facing

4-C Install Forward-Facing With Vehicle Seat Belt

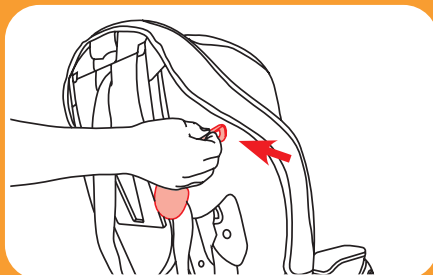
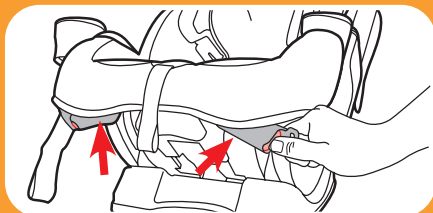
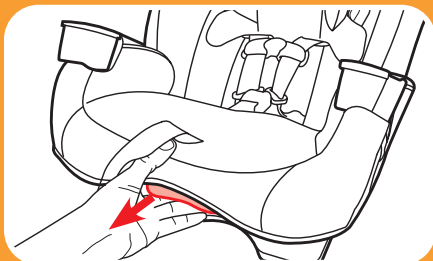

1. Recline the Car Seat

Place the car seat in recline position 3 or 4.

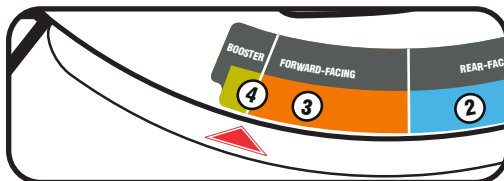

2. Store Lower Anchor Connectors

Attach the lower anchor connectors to plastic bar as shown and remove the slack from the strap.

3. Place Car Seat Forward-Facing in Back Seat of the Vehicle

Place the base flat on the vehicle seat. Push it back firmly until the back of the car seat touches the vehicle seat back.

Make sure base is a minimum of 80% on the vehicle seat.

4. Unhook Tether Strap From Storage Location and Lay it in the Seat

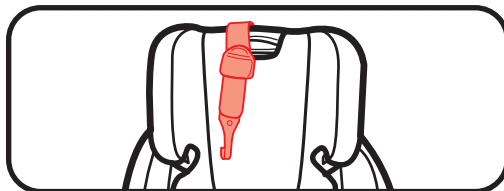

Review your vehicle's owner manual for vehicle seat belt use

5. Route the Vehicle Seat Belt

Thread vehicle seat belt through the forward-facing belt path (marked with an orange label) and buckle it. The seat belt should lay as flat as possible and not be twisted.

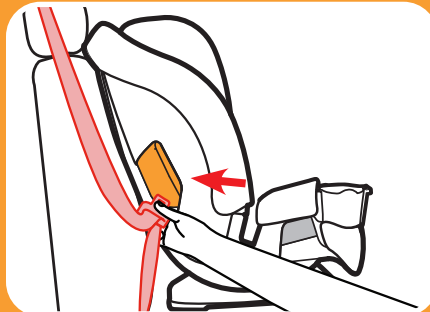

6. Lock the Vehicle Seat Belt

In most vehicles today, slowly pull the shoulder belt all the way out and then let it go back in. You will hear a clicking sound. Slowly pull out on the belt and it should be locked. If not, review your car's owner manual and section 9-E.

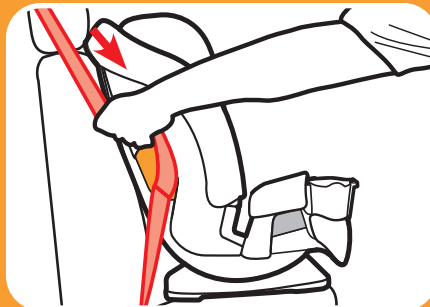

7. Tighten the Vehicle Seat Belt

Press down firmly in the center of the car seat. Pull on the shoulder belt to tighten while feeding the slack back in the retractor.



8. Attach Tether Strap

Extend the top tether by lifting up on the tether lock and attach.

Consult vehicle's owner manual for specific location.

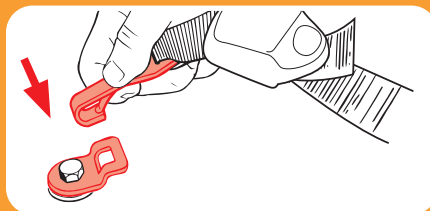
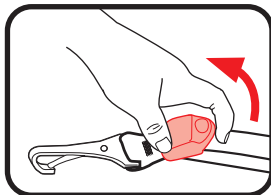

4 Forward Facing

9. Tighten Tether Strap

Remove all the slack.

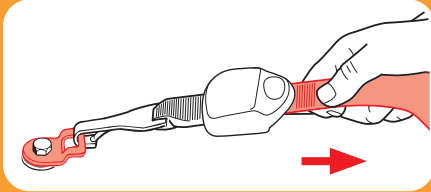

10. Test For Tightness

Grab the sides of the seat where the forward-facing belt path is and slide the car seat side to side and front to back.

If the seat moves less than 1" (2.5 cm), it is tight enough.

See section 6-A to secure your child.

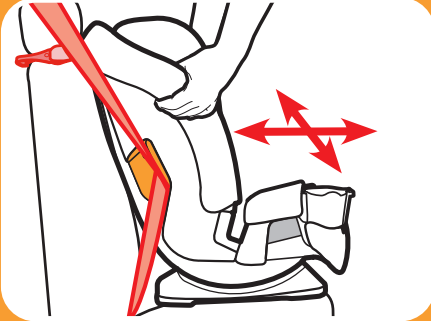

5-A Booster Use

Booster Use:

40-100 lb (18.1-45 kg)

43-57" (110.1-145 cm)

At least 4 years old

- Car seat must be forward-facing in the vehicle back seat.
- Vehicle seat belts **MUST** lay flat against child and **MUST NOT** be twisted.
- Make sure vehicle seat's lap belt is adjusted snugly, lays low on the child's hip, and is routed behind the armrest in the booster's belt path marked with a green label.
- Make sure vehicle seat's shoulder belt is centered between the child's neck and edge of shoulder.
- **Never** use a vehicle lap only seat belt across front of child.
- **DO NOT** position vehicle shoulder belt under the child's arm or back.
- **DO NOT** allow child to slouch or slide down in the booster seat.
- **DO NOT** position vehicle seat belt over top of armrests.
- Vehicle seat's headrest **SHOULD NOT** create a gap between vehicle seat and booster seat.
- The front of booster seat base **MUST NOT** hang over front of vehicle seat.
- If child will not keep the vehicle seat belt properly positioned, **DO NOT** use this booster seat. Use a different car seat.
- When forward-facing, children should use the built-in harness system for as long as possible until they reach the maximum forward-facing weight or height for their car seat. At that point, children should ride in a belt-positioning booster seat. A booster is no longer needed once the vehicle seat belt fits properly, typically when they reach 4 feet 9 inches (145 cm) tall and are between ages 8-12. Be sure to check your local and state laws, as well as AAP and NHTSA recommendations, for car seat usage.

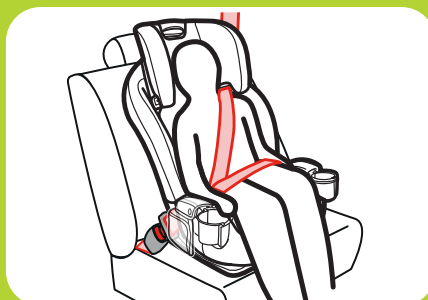

Vehicle Lap/Shoulder Seat Belt



Never use a vehicle lap only seat belt across front of child.

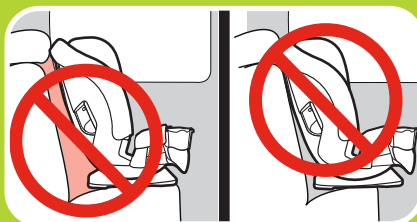

5 Booster

5-B Install Highback Booster

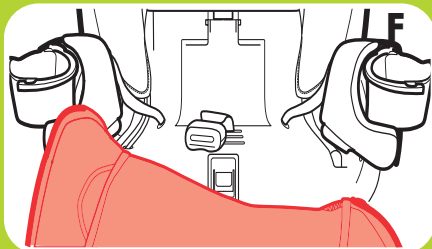
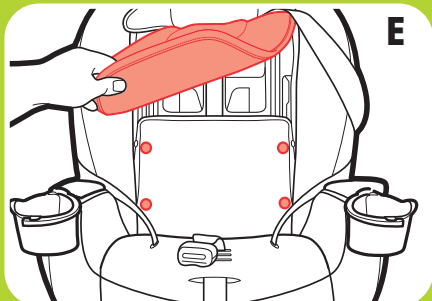
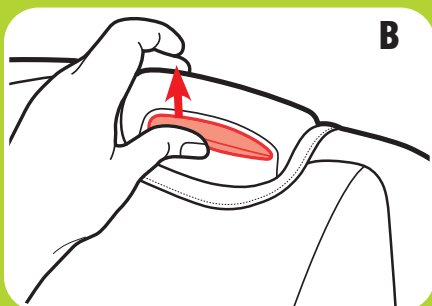
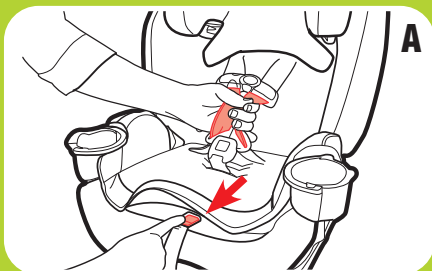

1. Store the Harness

Push down on the harness release lever while pulling out on the harness straps at the chest clip. (A)

Raise the headrest to the highest position. (B)

Unbuckle the chest clip and the buckle. (C and D)

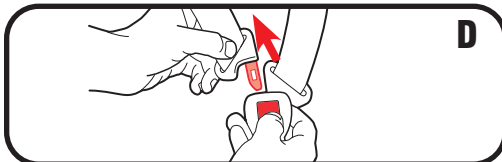
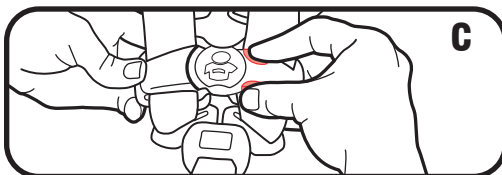

Remove the Lower Seat Pad to Expose the Harness Storage Door.

Undo the 4 snaps on the lower seat pad (E, F and G).

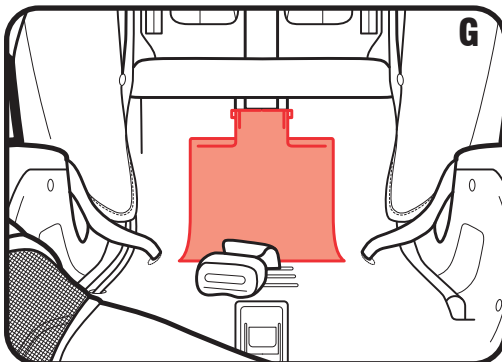

Move Buckle Strap to Rear Slot

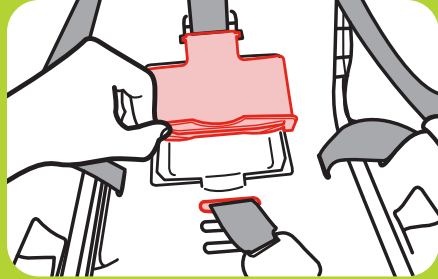

Open the Harness Storage Door and Place Harness, Chest Clip, Buckle, and Buckle Tongues Inside Storage Compartment. Close the Door

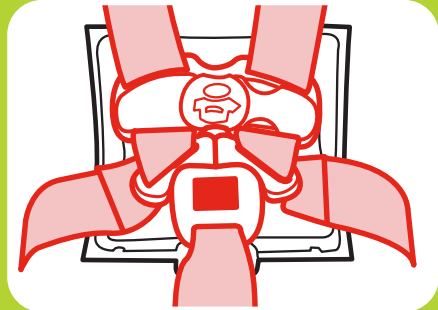

Replace Seat Pad

Move the headrest back to its proper position for your child.

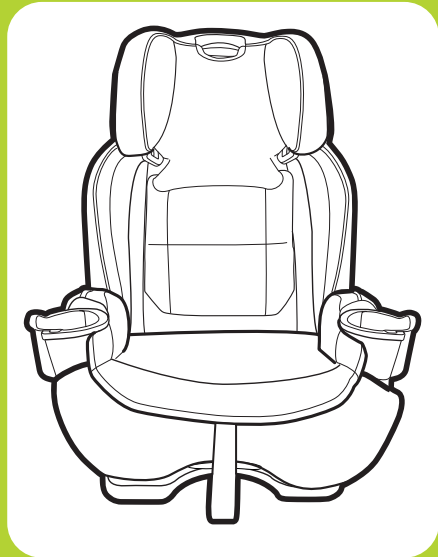

5 Booster

2. Recline the Car Seat

Place the booster seat in recline position 4.

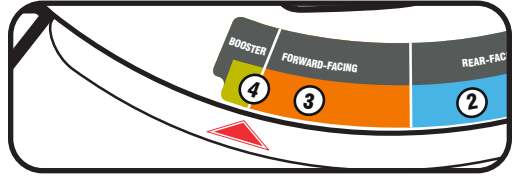
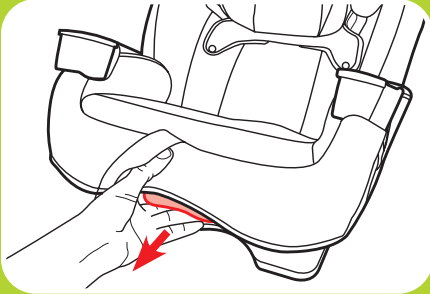

Graco allows the securing of the car seat with LATCH in the booster mode. The child still **MUST BE SECURED** with the vehicle lap/shoulder seat belt. LATCH can be used in the booster mode regardless of the weight of the child up to 100 lb (45 kg).

Verify the following before using LATCH in the booster mode:

- The lower anchor connector **DOES NOT** interfere with any vehicle seat belts or buckles.

If the lower anchor connector interferes with the vehicle seat belts or if the chosen seating position does not have lower anchors, you **MUST** store the lower anchor strap. Always secure car seat with lower anchor strap or a vehicle seat belt, even when unoccupied. In a crash, an unsecured car seat can injure passengers. Store the tether strap as shown.

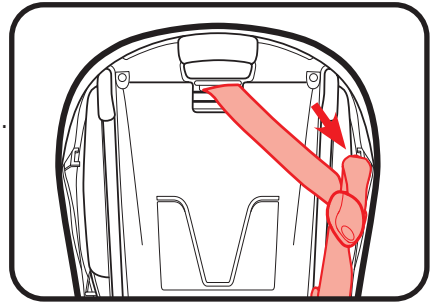
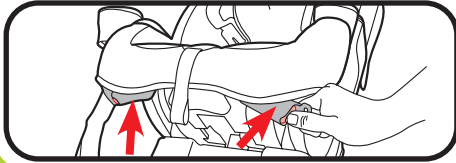

3. Place the Booster Seat Forward-Facing in the Back Seat of Vehicle

Place forward-facing on a vehicle seat that has a lap/shoulder seat belt. The base should sit as flat as possible on the vehicle seat.



Skip to Step 10 if Not Using LATCH



4. Make Sure Lower Anchor Strap is in the Forward-Facing Belt Path, Marked with Orange Label

If it is not, see section 7-A.

5. Unhook Tether Strap From Storage Location and Lay it in the Seat

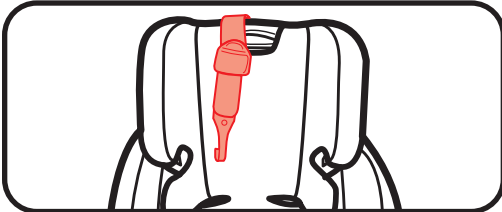

6. Connect Lower Anchor Connectors to Vehicle's Lower Anchors

Lower anchor strap should not be twisted.

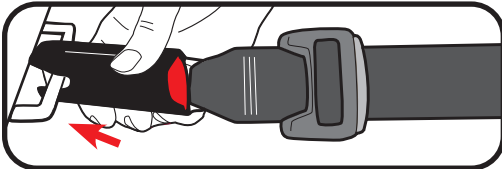

7. Tighten the Lower Anchor Strap

Remove all the slack.

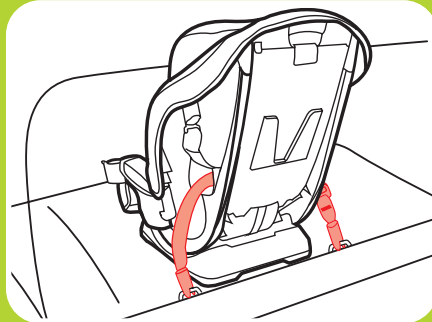
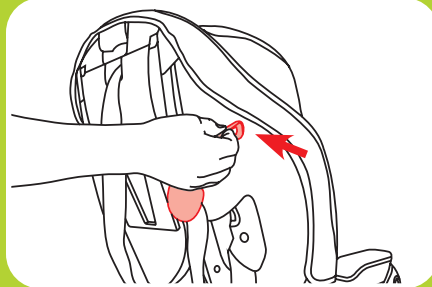
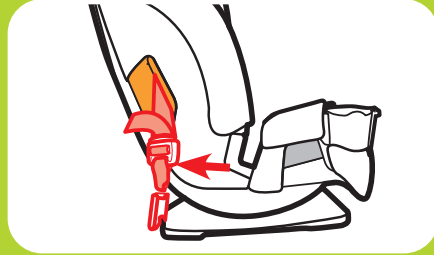

5 Booster

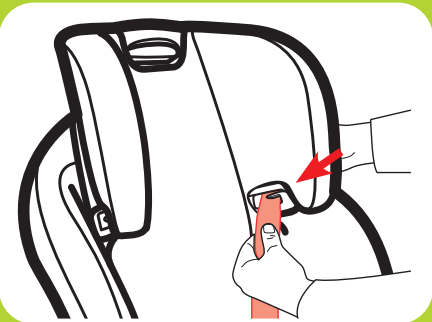
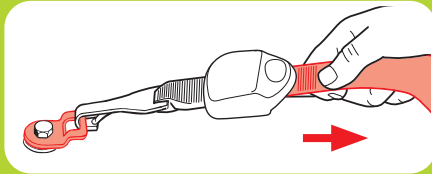
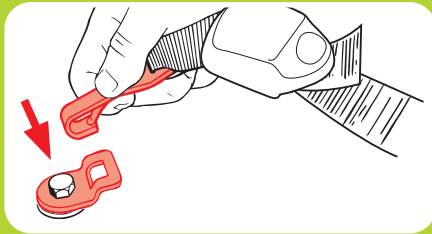

8. Attach Tether Strap

Extend the tether by lifting up on the tether lock and attach.

Consult vehicle's owner manual for specific location.

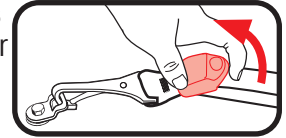

9. Tighten Tether Strap

Remove all the slack.

10. Thread the Vehicle Shoulder Belt Through Shoulder Belt Guide on the Headrest

See section 6-B to secure your child.

6-A Securing Child 5-point Harness



1. Loosen Harness Straps

Push down on the harness release lever while pulling out on the harness straps at the chest clip. (A)

Unbuckle the chest clip (B) and the buckle (C). Place harness straps off to the sides.

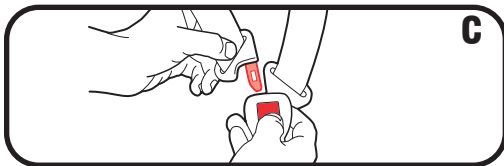
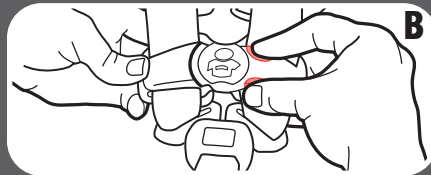
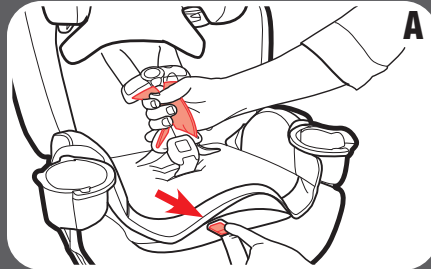

2. Place Your Child in the Seat

Make sure their back is flat against the car seat back.

Avoid bulky or heavy clothing when it is cold out. Doing so will prevent the harness straps from tightening properly. If needed, place a blanket over the child after you have secured them.

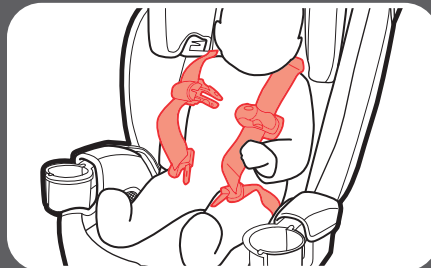

3. Place Harness Straps Over Child's Shoulders and Buckle

You will hear a “click” when buckle tongues are securely attached. Pull up on each buckle tongue to make sure it is securely attached.

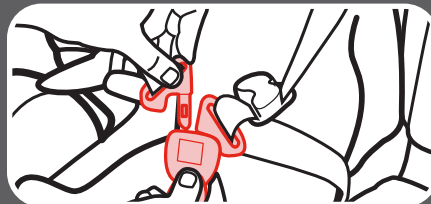



Rear-Facing



Forward-Facing

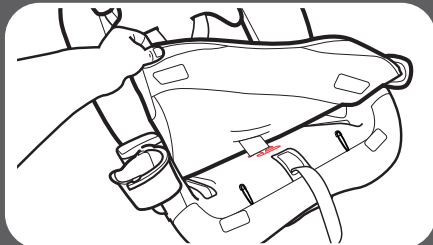
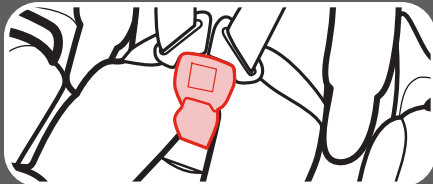
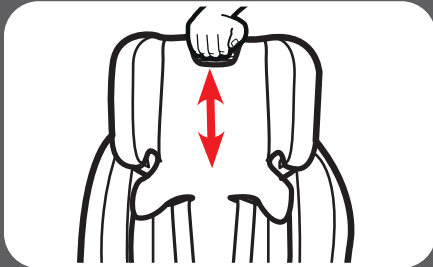
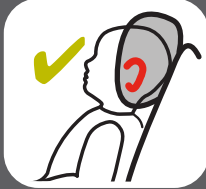

4. Be Sure the Harness Straps Are at the Proper Height

Rear-Facing: Harness straps must be **at or just below** the child's shoulders and top of head **must be at least 1" (2.5 cm) below** the headrest/harness adjustment handle.

Forward-Facing: Harness straps must be **at or just above** the child's shoulders and top of child's ears must be **below** top of headrest.

To Raise or Lower Headrest/Harness Height

Squeeze the adjustment handle and move headrest for the proper harness height.

Check to make sure the headrest is locked securely by gently pulling up on the head support.

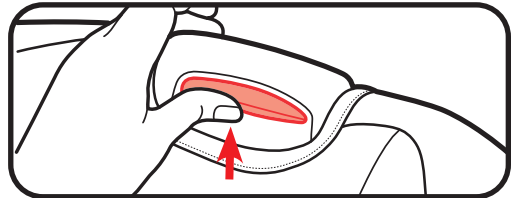

5. Check the Buckle Position

The correct slot is the one that is closest to your child without being underneath them.

To Adjust, Lift the Lower Seat Pad From Front of Car Seat to Expose The Buckle Slots

Turn Buckle Strap Sideways and Slide to Desired Slot

Make sure buckle strap is in one of the three positions.

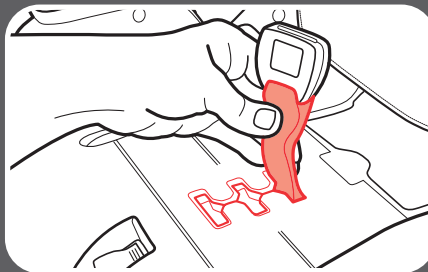
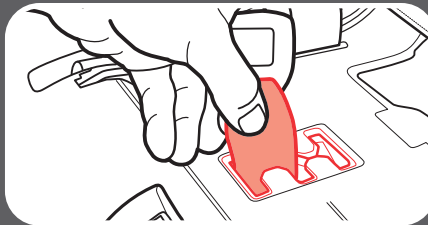

Make Sure Lower Anchor Strap is in Front of Buckle Strap

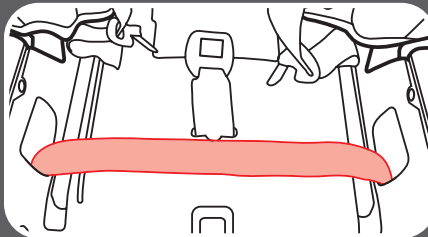

6. Replace Seat Pad, Making Sure the Buckle Goes Through the Same Slot in the Seat Pad as in the Plastic Shell

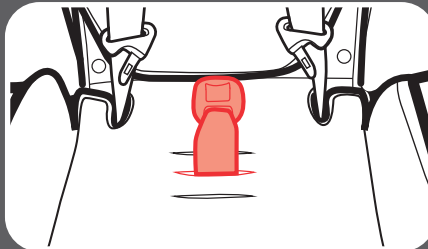

7. Buckle the Chest Clip

You will hear a “click” when the chest clip is securely buckled.

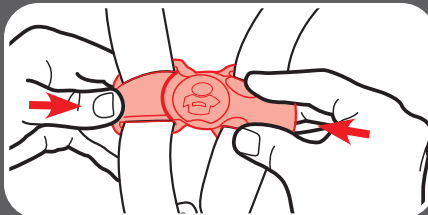

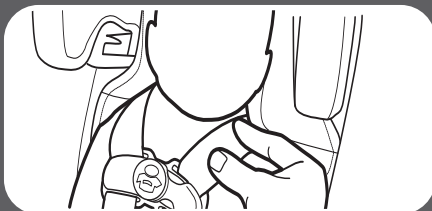
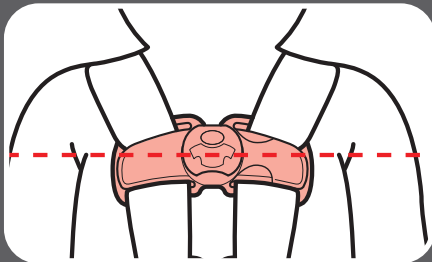
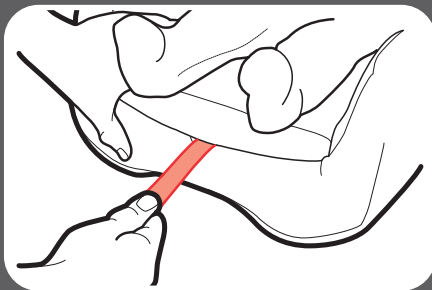
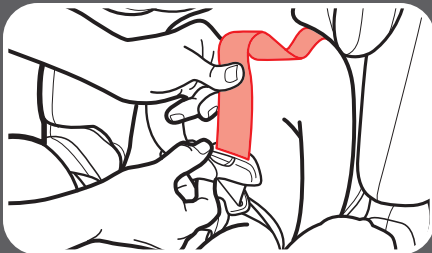

8. Pull All the Slack Out From Around the Waist

Pull up on the harness strap while pushing the chest clip down. Do this to both sides.

9. Tighten the Harness by Pulling the Harness Adjustment Strap

A snug harness should not allow any slack. It lies in a relatively straight line without sagging. It does not press on the child's flesh or push the child's body into an unnatural position.

When you are not able to pinch any of the harness webbing at your child's shoulder, the harness is tight enough.

10. Raise the Chest Clip to Child's Armpit Level

11. Check Tightness

Tighten more if needed.

6-B Securing Child Highback Booster



⚠️WARNING!

Warning! Use only the vehicle lap and shoulder belt system when restraining the child in the booster seat.

1. Place Child In Seat

Have your child sit in the booster seat, with their back flat against the back of the booster seat.

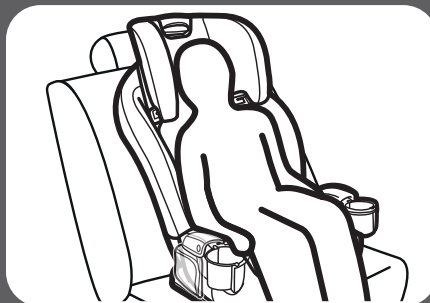

2. Thread Vehicle's Shoulder Belt Through Booster Shoulder Belt Guide in the Headrest

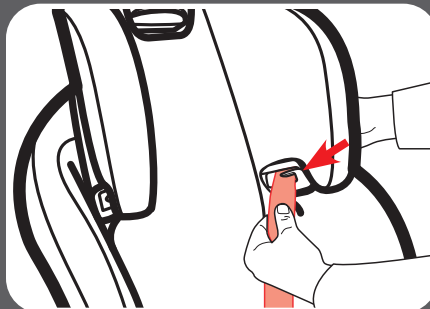

3. Buckle the Vehicle Lap/Shoulder Seat Belt

Be sure the lap portion of the vehicle seat belt goes behind the armrests. Both the lap and shoulder belt must lay in the booster belt path on the buckle side of the seat.

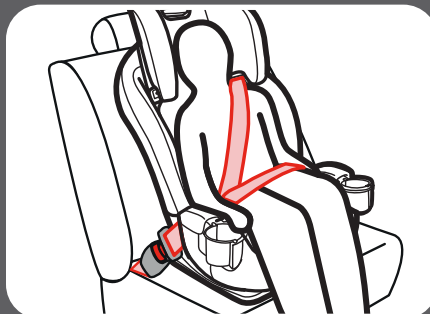
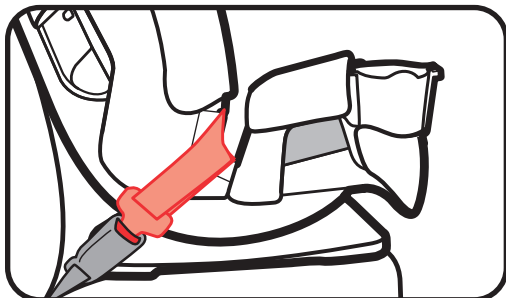

6 Securing Child

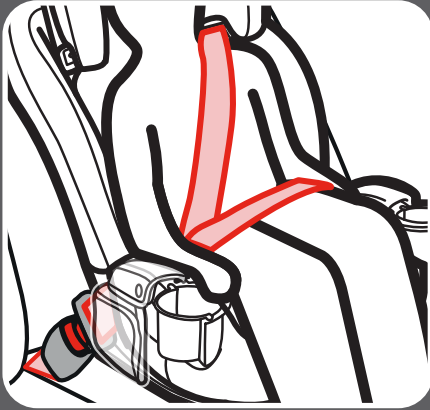

Be sure the lap portion of the vehicle seat belt is low across your child's hips.

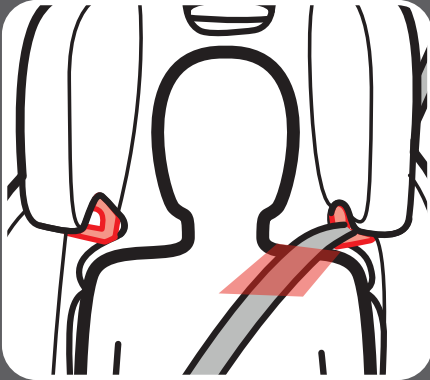

Vehicle seat's shoulder belt should be centered between the child's neck and edge of shoulder.

Raise or lower the headrest to change the shoulder belt location on the child.

Check to make sure the headrest is locked securely by gently pulling up on the head support.

7-A Moving Lower Anchor Attachment

1. For Ease of Moving the Lower Anchor Attachment

- A. Push down on the harness release lever while pulling out on the harness straps at the chest clip.
- B. Raise the headrest to the highest position.
- C. Unbuckle the chest clip.
- D. Unbuckle the buckle.

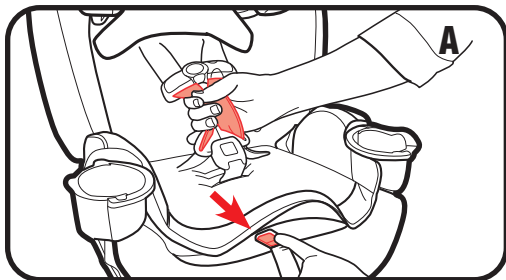

2. Remove the Lower Seat Pad to Expose the Lower Anchor Strap

Undo the 4 snaps on the lower seat pad then remove the pad.

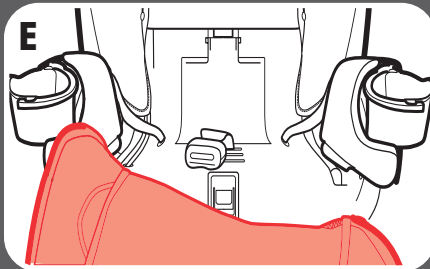
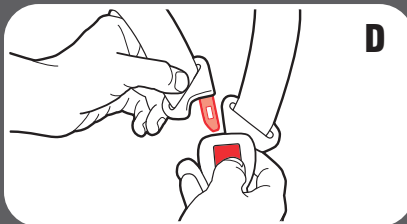
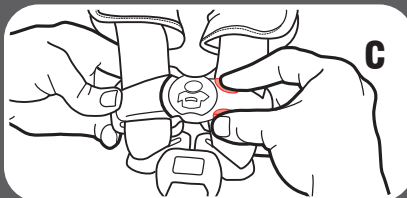
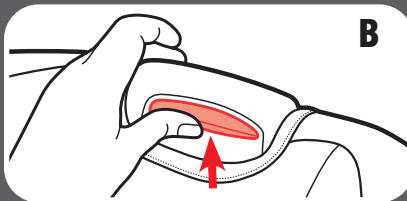
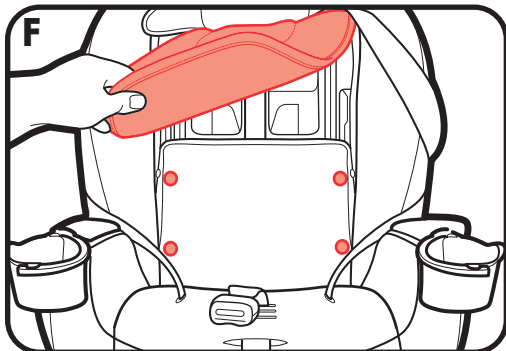

7 Moving Lower Anchor

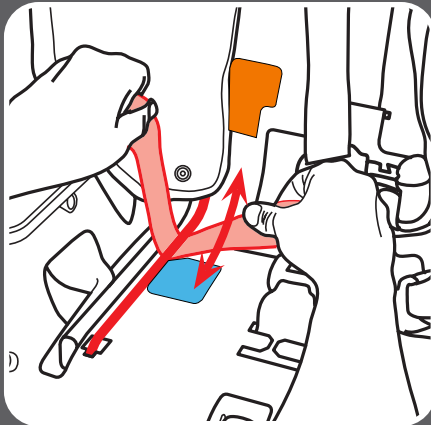
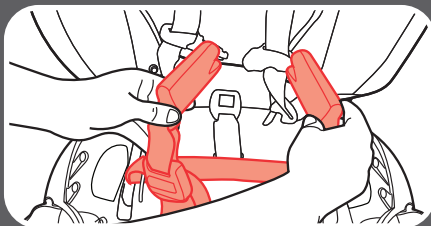
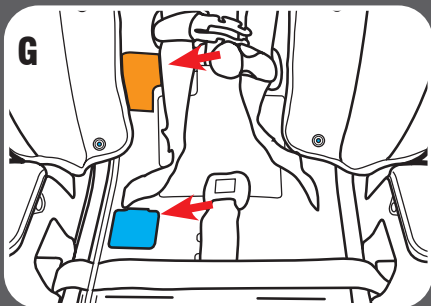

Note the orange and blue labels at the top and bottom of the red bar (G).

3. Pull Lower Anchor Connectors Out of the Belt Path Openings into the Center of the Car Seat

4. Slide Entire Lower Anchor Strap Along the Red Bar to the Desired Belt Path Openings

Rear-Facing: Slide lower anchor strap along bar to the front of the seat.

Forward-Facing: Slide the lower anchor strap up along bar to the top.

5. Push the Lower Anchor Connectors Out Through the Desired Belt Path Openings on Each Side of Car Seat

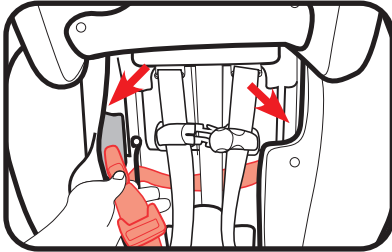

OR

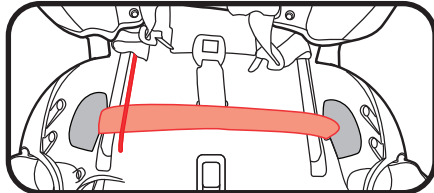
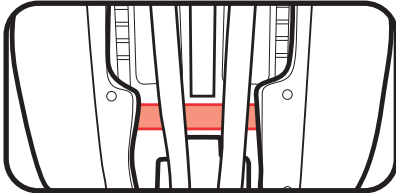
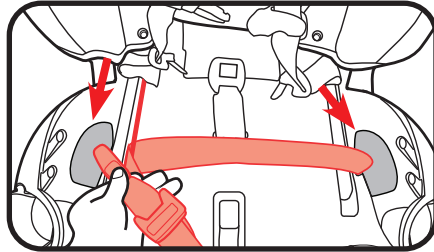

Forward-Facing: Make sure the lower anchor strap is routed behind the harness strap, is flat, and is not twisted.

Rear-Facing: Make sure the lower anchor strap is in front of the buckle strap, is flat, and is not twisted.

6. Replace Seat Pad

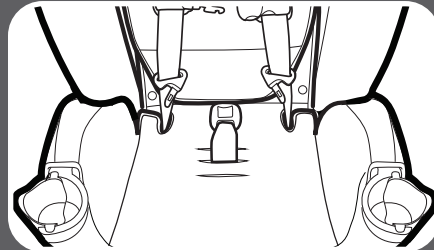

7. Move the Headrest to Its Proper Position for Your Child

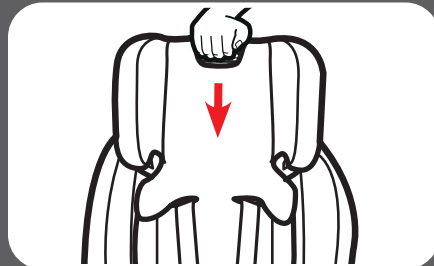

7 Moving Lower Anchor

8-A Accessories *(on select models)*

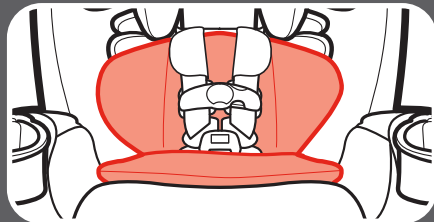
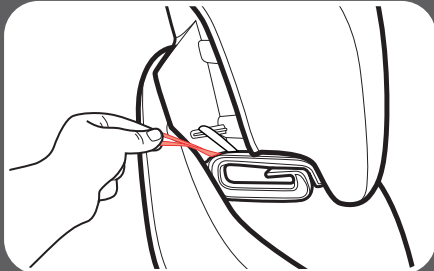
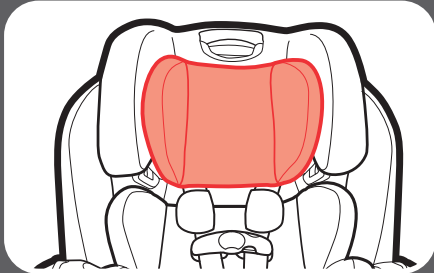
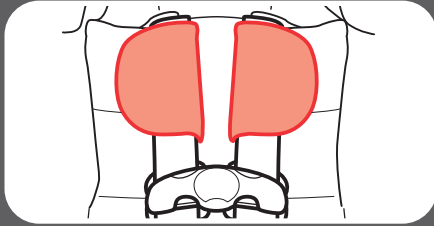

Infant Head Support and Body Support can be used *ONLY* for children weighing less than 20 lb (9 kg).

Harness Covers

Make sure that harness covers do not interfere with placement of the chest clip at armpit level.

To remove, undo the fastening strips and remove.

Infant Head Support

To remove, unhook the elastic straps on the sides of the headrest.

Body Support

Body support must be used if shoulders are below the lowest harness setting.

Never allow body support to bunch or fold behind child.

To remove, unbuckle the buckle and pull out the body support.

Cup Holder

To use cup holder, lift the inside cup (A) and rotate until it locks into place (B).

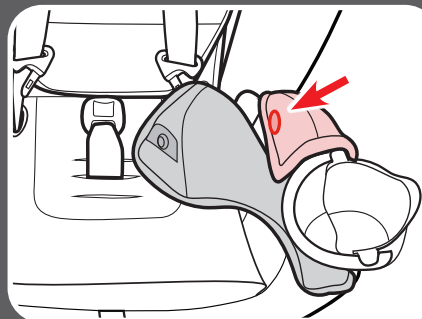
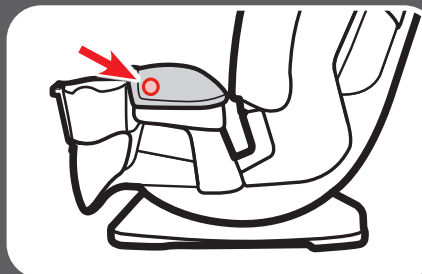
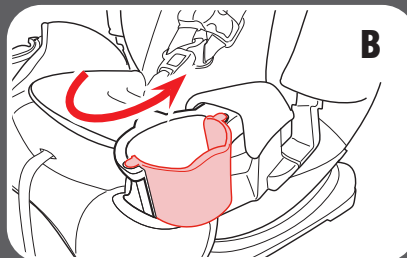
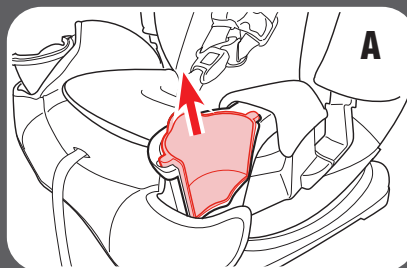

MyPocket™ Storage Pockets

Make sure that the Lower Anchor straps or the vehicle seat belt do not lay on top of the MyPocket™ Storage Pockets when in use.

DO NOT place sharp objects or objects weighing more than 1 lb (0.5 kg) in the MyPocket™ Storage Pockets.

Note: The small pocket goes on the child's right side, and the large pocket goes on the child's left side. The pockets are not interchangeable.

To attach, undo the snap on the side of the armrest cover.

Flip the armrest cover up and out of the way. Attach the MyPocket™ Storage Pocket to the snap on the inside of the armrest.

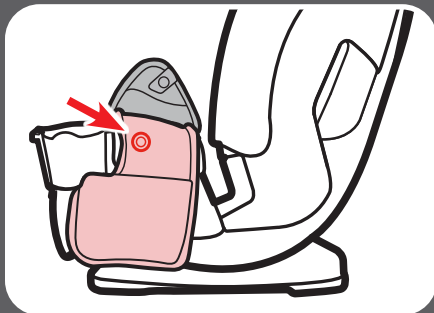

Attach the MyPocket™ Storage Pocket to the snap on the outside of the armrest.

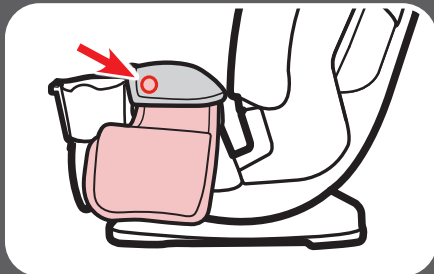

Reattach the armrest cover using the snap on the side of the MyPocket™ Storage Pocket.

Reverse the steps to remove the MyPocket™ Storage Pockets.

Note: It is not required to install the MyPocket™ Storage Pockets to use this car seat.

9-A How to Uninstall Lower Anchor Connectors and Tether

Lower Anchor Connectors

To remove the lower anchor connectors from the lower anchors, push in on the red buttons and pull them off.



Tether

To remove, lift up on the tether lock to release the tension.

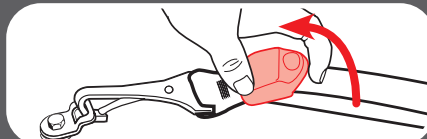

Press in on the hook's spring. Push tether hook in, then lift up and pull away from tether anchor.

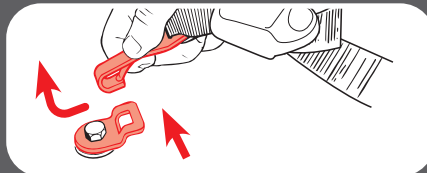

9-B Choosing Vehicle Seat Location

Review your vehicle owner's manual for seating locations.

The best seating location for this car seat is one that:

- Is recommended by your vehicle owner's manual, and
- Results in a secure installation of this car seat.

In the event there is no available back seat and / or you have no other option than to place a child other than an infant in a rear-facing car seat in a front passenger seating position, the National Highway Traffic Safety Administration (NHTSA) recommends that you take the following steps:

- Ensure the child is properly restrained according to their age and size.
- Move the seat as far back as possible.
- Make sure the child is not leaning out of position, such as leaning forward into the deployment path of the air bag.
- Set the air bag ON-OFF switch, if available, to the OFF position.

9-C Which Installation Method Should I Use?

This car seat can be installed in your vehicle using either the vehicle seat belt OR the LATCH system OR the lower anchor system. All are equally safe to use. **INSTALL USING ONLY ONE METHOD.**

Vehicle Seat Belt: Review this section and your vehicle owner's manual to learn how to install your car seat with the vehicle seat belts.

LATCH or Lower Anchor Attachment: The LATCH system or Lower Anchor Attachment allows you to securely attach your safety seat in your car without using the vehicle seat belt and possibly to get a better fit. All 2003 and newer model year vehicles are required to have a LATCH system, although some manufacturers began including LATCH earlier. Some vehicle owner manuals use the term ISOFIX to identify the LATCH system.

Review your vehicle's owner manual for exact location and use.

Vehicle Tether Anchor

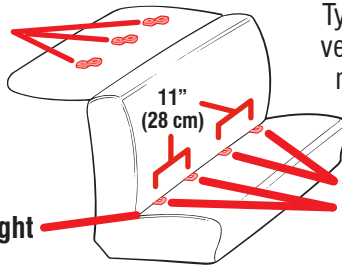

Typical seat in a passenger vehicle. Other vehicle types may have different lower anchor locations.

Vehicle Seat Belt

Vehicle Lower Anchor



9-D Unsafe Vehicle Seat Locations

Never install this car seat in any of the following vehicle seating locations:



rear-facing or side-facing vehicle seats



rear-facing with an active front air bag



booster mode with vehicle lap only seat belt

9-E Vehicle Seat Belts

Review your vehicle owner's manual for vehicle seat belt use

This car seat can be installed using a vehicle seat belt. To do this, you will need to change the seat belt to a locked mode for use with car seats. With some vehicle seat belts, this is done with the latchplate; with other vehicle seat belts, this is done with the retractor.

Vehicle Seat Belt Terms

Retractor

A device that winds up the unused vehicle seat belt. It is often hidden inside the panels on the walls of the vehicle or in the vehicle seat back.

Latch Plate

The male end of the seat belt with the silver tongue.

Seat Crease

The crease where the vehicle seat back and seat bottom meet.

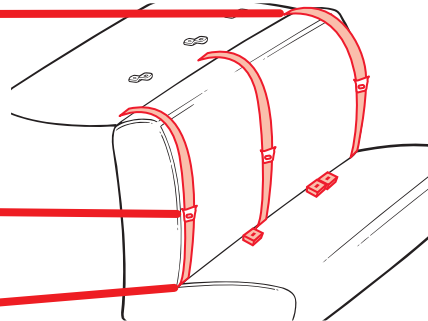

Identify Your Seat Belt Type

There are two different types of vehicle seat belts that can be used with this car seat:

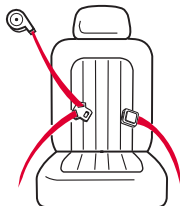

Lap/Shoulder Seat Belt

3 connection points. Can be used in all car seats modes of use.

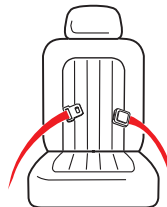

Lap Only Seat Belt

2 connection points. **Can ONLY be used in harness mode.**

The following types of vehicle seat belts **CANNOT** be used safely with this car seat:



Lap Belt with Motorized Shoulder Belt



Lap Belt or Shoulder Belt Mounted on Door

Belts Forward of the Seat Bight

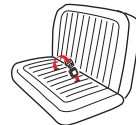

Some vehicles you may not get a secure fit. Read both your vehicle and car seat manuals.

Lap/Shoulder Seat Belt Installation - Harness Mode

Always review your vehicle owner's manual for specific information about your vehicle seat belts.

Most vehicles manufactured after 1996 will have Switchable retractors in the back seat. If you have any questions about your retractor type, consult your vehicle owner's manual, call Graco or visit www.gracobaby.com/vehicle-seatbelt-information.

To verify you have a Switchable retractor, **slowly** pull the belt all the way out, and then allow it to retract several inches. Try to pull the belt all the way out again. If it cannot be pulled out, it is **Switchable** retractor. Follow the steps in the rear-facing/forward-facing sections in this manual.

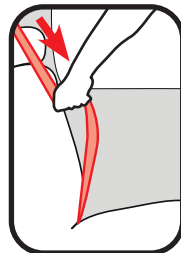

10-A Cleaning RapidRemove™ Seat Pad and MyPocket™ Storage Pockets

Clean with a damp sponge using mild soap and cool water. Refer to seat pad care tag for washing instructions.

Headrest Pad

If needed, headrest pad may be removed for cleaning.

To remove, pull the plastic tab out of the slots just below the adjustment handle.

Remove the elastic straps from the hooks on both sides of the headrest.

Pull pad off of headrest.

Machine wash cover in cold water on delicate cycle and drip-dry. **DO NOT USE BLEACH.**

Reverse the steps to reattach the cover on the headrest.

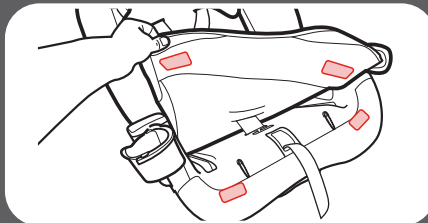
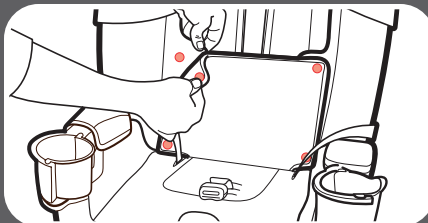
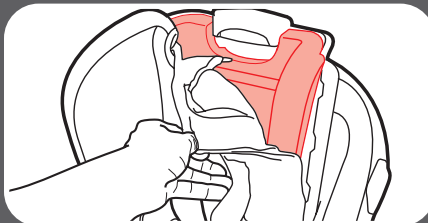
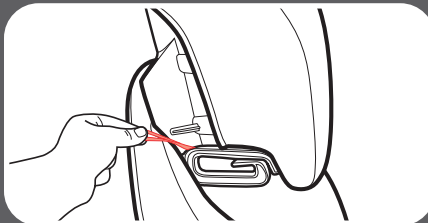
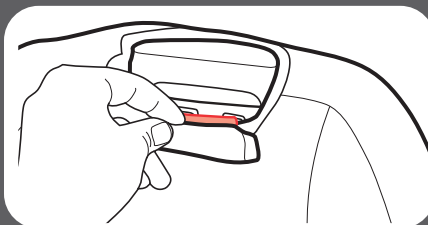

Lower Seat Pad

If needed, lower seat pad may be removed for cleaning.

To remove, unsnap lower seat pad from side pad.

Pull up on the seat pad to undo the fastening strips.

Pull the pad off.

Machine wash cover in cold water on delicate cycle and drip-dry. **DO NOT USE BLEACH.**

Reverse the steps to reattach the lower seat pad.

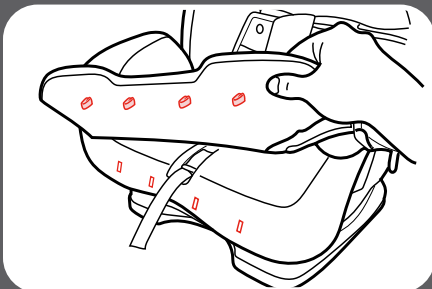
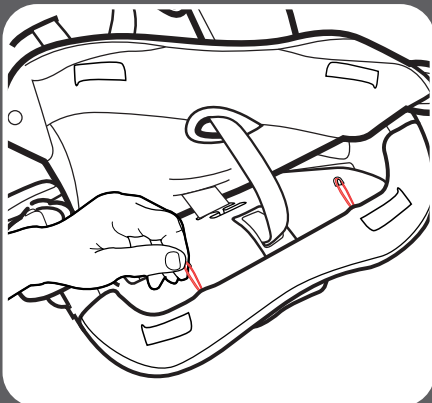
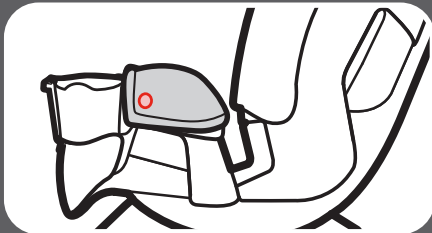

Front Pad

If needed, front seat pad may be removed for cleaning.

To remove, undo the snaps on the sides of both armrests.

Remove the elastic straps from the hooks in the rear-facing belt path.

Undo the elastic loops on top of the front pad.

Then undo the pins by pulling the pad away from the seat.

Pull the pad off.

Machine wash cover in cold water on delicate cycle and drip-dry. **DO NOT USE BLEACH.**

Reverse the steps to reattach the front seat pad.

Side Pad

If needed, side pad may be removed for cleaning.

To remove, undo the elastic straps from the hooks in the forward-facing belt path.

Slide the upper-pocket of the side pad off of the seat shell from both sides of the seat.

Slide the corner-pocket of the side pad off of the seat shell from both sides of the seat.

Pull the pad off from around the level indicator.

Machine wash cover in cold water on delicate cycle and drip-dry. **DO NOT USE BLEACH.**

Reverse the steps to reattach the side pad.

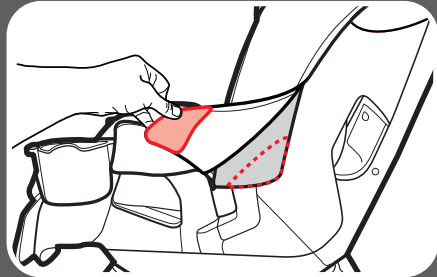
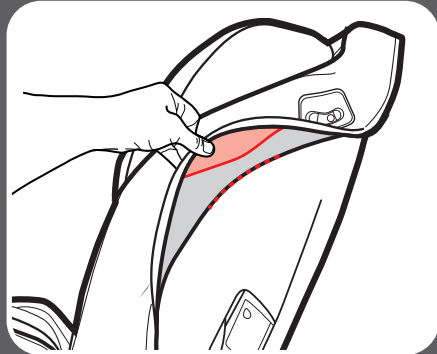
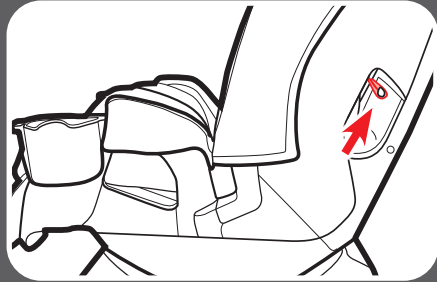

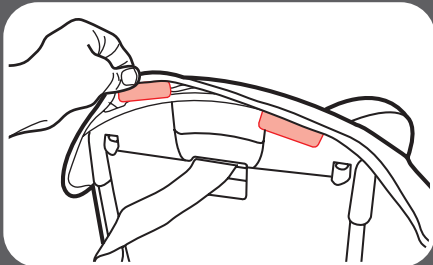
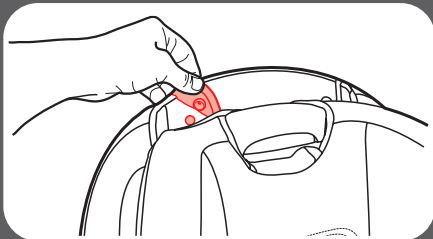

Top Pad

If needed, the top pad may be removed for cleaning.

After the side pad is removed, lower the headrest and unsnap the snaps from the seat shell on the front.

Then pull out the two tabs on the back of the seat.

Machine wash cover in cold water on delicate cycle and drip-dry. **DO NOT USE BLEACH.**

Reverse the steps to reattach the top pad.

MyPocket™ Storage Pockets

If needed, the MyPocket™ Storage Pockets may be removed for cleaning. See section 8-A to remove the MyPocket™ Storage Pockets.

Machine wash MyPocket™ Storage Pockets in cold water on delicate cycle and drip-dry. **DO NOT USE BLEACH.**

10-B Cleaning Crotch Buckle

Recline the car seat and locate the metal retainer. Rotate the metal retainer up through the shell and pad. From the front, pull out the buckle.

To clean buckle, place in a cup of warm water and gently agitate the buckle. Press the red button several times while in the water.

DO NOT SUBMERGE THE BUCKLE STRAP. DO NOT USE SOAPS, HOUSEHOLD DETERGENTS or LUBRICANTS.

Shake out excess water and allow to air dry. Repeat steps as needed until it fastens with a click. Re-insert the buckle into the same slot it was removed. Pull up on buckle to make sure it is secured.

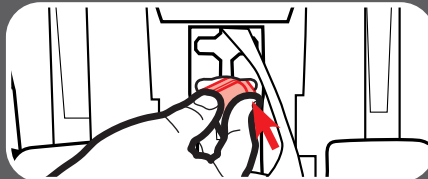

WARNING! Inspect and clean buckle from time to time to remove any objects or debris that could prevent latching.

10-C Cleaning Harness, Lower Anchor and Tether Straps

Surface wash only with mild soap and damp cloth. **DO NOT IMMERSE THE HARNESS STRAPS or LOWER ANCHOR STRAP or TETHER STRAP IN WATER.** Doing so may weaken the straps. If harness straps or lower anchor belt or tether strap are frayed or heavily soiled, contact Customer Service at www.gracobaby.com or 1-800-345-4109.

Replacement Parts

To purchase parts or accessories in the United States,
please contact us at the following:

www.gracobaby.com

or

1-800-345-4109

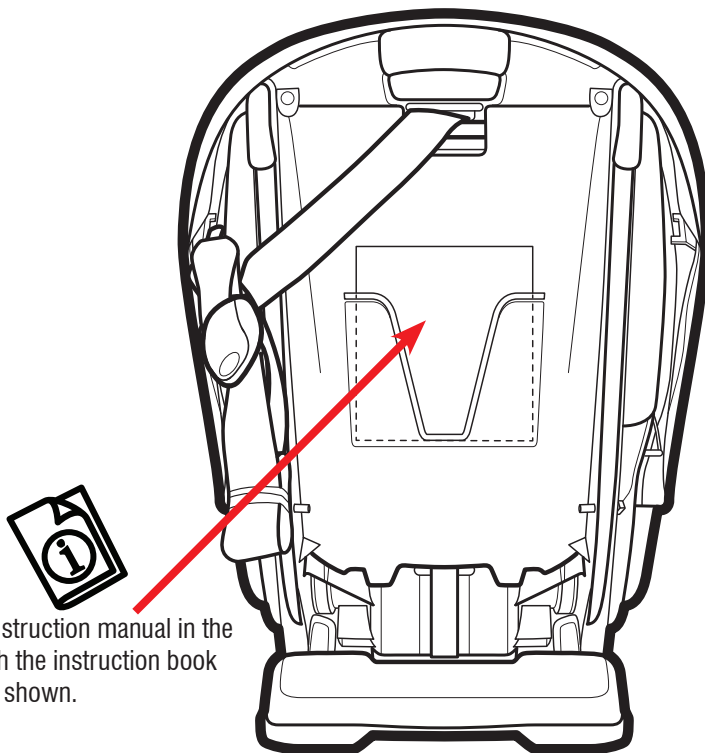

Store instruction manual in the
slot with the instruction book
icon as shown.