

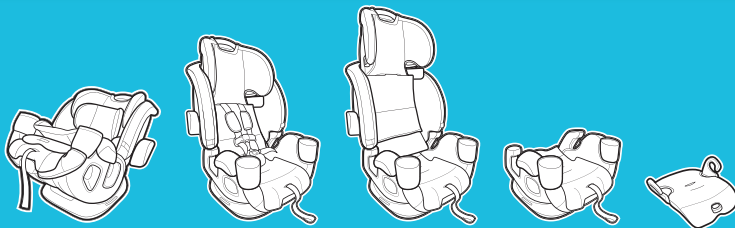

4EVER[®] DLX GRAD

5-IN-1 CAR SEAT

Read This Instruction Manual



Do not install or use this child restraint until you read and understand the instructions in this manual.

FAILURE TO PROPERLY USE THIS CHILD RESTRAINT INCREASES THE RISK OF SERIOUS INJURY OR DEATH IN A SUDDEN STOP OR CRASH.



Scan the code or visit www.gracobaby.com to view installation videos.

1 Important

Pages 6-14

1-A Welcome to the Graco Family

If You Need Help

1-B Quick Guide to Your Manual

Register This Car Seat

1-C Safety Warnings

Car Seat's Useful Life

Warm Weather Use

1-D Right Mode of Use

Certification

2 Car Seat Features

Pages 15-19

3 Rear-Facing

Pages 20-44

- 3-A Rear-Facing Use**
- 3-B Install Rear-Facing with Lower Anchor Attachment**
- 3-C Install Rear-Facing with Vehicle Seat Belt**

4 Forward-Facing

Pages 45-62

- 4-A Forward-Facing Use**
- 4-B Install Forward-Facing with LATCH**
- 4-C Install Forward-Facing with Vehicle Seat Belt**

5 Securing Child 5-Point Harness

Pages 63-71

6 Moving the Lower Anchor Attachment

Pages 72-77

7 Booster

Pages 78-114

- 7-A Booster Use**
- 7-B Install Highback Booster**
- 7-C Install Backless Booster**
- 7-D Install Seat Belt Trainer**
- 7-E Securing Child Highback Booster**
- 7-F Securing Child Backless Booster**
- 7-G Securing Child Seat Belt Trainer**

8 Installing and Removing Seat Belt Trainer From Car Seat

Pages 115-119

9 Accessories

Pages 120-122

10 Additional Information

Pages 123-132

10-A How to Uninstall Lower Anchor Connectors and Tether

10-B Choosing Vehicle Seat Location

10-C Which Installation Method Should I Use?

10-D Unsafe Vehicle Seat Locations

10-E Vehicle Seat Belts

10-F Aircraft Installation

11 Care & Cleaning

Pages 133-139

11-A Cleaning Seat Insert

11-B Cleaning the Seat Pads

11-C Cleaning the Buckle

11-D Cleaning Harness, Lower Anchor Attachment and Tether



Important

1

1-A Welcome to the Graco Family!

Your child's safety depends on you. **No car seat can guarantee protection from injury in every situation, but proper use helps reduce the risk of serious injury or death. READ THIS MANUAL CAREFULLY.**

This child restraint system conforms to all applicable Federal motor vehicle safety standards.

Even if this car seat seems easy to figure out on your own, you must follow the detailed instructions in this instruction manual to ensure the steps are performed correctly.

If You Need Help

In the U.S.A, please contact our Customer Service Department with any questions you may have concerning parts, use, or maintenance. When you contact us, please have your product's model number and date of manufacture ready so that we may help you efficiently. These numbers can be found on a sticker on the bottom of your car seat.

Contact us at **www.gracobaby.com or call 1-800-345-4109.**

For additional resources or to get your car seat checked by a child passenger safety technician, please visit the following web sites:

www.nhtsa.gov • www.seatcheck.org • www.safekids.org • www.cpsc.gov

1-B Quick Guide to Your Manual

This car seat is for children:

Rear-Facing: 4-40 lb (1.8-18 kg)

Forward-Facing: 26.5-65 lb (12-30 kg)

Highback Booster: 40-100 lb (18.1-45 kg) at least 4 years old

Backless Booster: 40-120 lb (18.1-54 kg) at least 4 years old

Seat Belt Trainer: 50-120 lb (22.5-54 kg) at least 5 years old

- Infants who weigh less than 26.5 lb (12 kg) **MUST be rear-facing**. Review section 1-D for more information.

Note: Preterm or low birth weight infants may be at special risk in a vehicle or aircraft. According to the AAP, these infants may suffer breathing issues if improperly reclined in a car seat. When rear-facing, use the corrected age for preemies. Graco advises that you have your physician or hospital staff evaluate your infant and recommend the proper car seat or car bed before you and your infant leave the hospital.



1 Important



Important

1

Register This Child Restraint

Please fill out the prepaid registration postcard attached to the harness and mail it in today **or register online at www.gracobaby.com/carseatregistration.** Child restraints could be recalled for safety reasons. You must register this restraint to be reached in a recall. Send your name, address, and the restraint's model number and manufacturing date to:

Graco Children's Products, Inc.

Attn: Customer Service

P.O. Box 169, Elverson, PA 19520-9901

or call 1-800-345-4109

or register online at

www.gracobaby.com/carseatregistration

For recall information, call the U.S. Government's Vehicle Safety Hotline at 1-888-327-4236 (TTY: 1-800-424-9153), or go to <http://www.NHTSA.gov>.

For future reference or if you change addresses, record the model name, model number, date of manufacture and purchase date of this car seat on the below. You can find this information either on the registration card if you still have it or on the date label located on the bottom of the car seat.

Model Name _____

Model Number _____

Date of Manufacture _____

Date of Purchase _____

1-C Safety Warnings



1 Important

! WARNING!

Failure to follow these instructions and child restraint's labels can result in child striking the vehicle's interior during a sudden stop or crash.



! NEVER PLACE THIS CHILD RESTRAINT REAR-FACING IN A VEHICLE SEATING LOCATION THAT HAS AN ACTIVE FRONT AIR BAG.

If an air bag inflates, it can hit the child and car seat with great force and cause serious injury or death to your child.

! Review your vehicle owner's manual for more information about air bags and car seat use.

! According to accident statistics, children are safer when properly restrained in the rear seating positions than in the front seating positions. The center of the back seat can be the safest during a possible side impact.





Important

1

- ! If your vehicle does not have a back seat, review your vehicle owner's manual.**
- ! Children are safer riding rear-facing and should ride rear-facing as long as possible, until they reach the maximum rear-facing height or weight rating for their car seat. Then children should ride forward-facing, using the built-in harness system for as long as possible until they reach the maximum forward-facing weight or height for their car seat. At that point, children should ride in a belt-positioning booster seat. A booster is no longer needed once the vehicle seat belt fits properly, typically when they reach 4 feet 9 inches (145 cm) tall and are between ages 8-12. Be sure to check your local and state laws, as well as AAP and NHTSA recommendations, for car seat usage.***
- ! Choose the correct mode of use for the car seat depending on your child's size. Infants less than 26.5 lb (12 kg) MUST use this car seat rear-facing.**
- ! Select a suitable location for the car seat in your vehicle.**
- ! Secure car seat with a vehicle seat belt or lower anchor attachment that is properly routed as shown in this manual.**
- ! Vehicle seat belt system MUST hold car seat securely. Not all vehicle seat belts can be used with a car seat.**

*Graco Supports the American Academy of Pediatrics and National Highway Traffic Safety Administration's Car Seat Guidelines. Visit www.gracobaby.com/en-US/safety for information on car seat usage recommendations.



1 Important

- ! If vehicle seat belt does not hold car seat securely, read “Vehicle Seat Belts” section 10-E and your vehicle owner’s manual.**
- ! Always secure car seat with lower anchor attachment or a vehicle seat belt, even when unoccupied. In a crash, an unsecured car seat can injure passengers.**
- ! If car seat is in a crash, it must be replaced. DO NOT use it again! A crash can cause unseen damage and using it again could result in serious injury or death.**
- ! DO NOT use car seat if it is damaged or missing parts.**
- ! DO NOT use accessories or parts other than those provided by Graco except for a thin towel or mat to protect your vehicle seat or rolled towels or pool noodles to help get your car seat level. Their use could alter the performance of the car seat.**
- ! DO NOT remove LATCH system from car seat. If using vehicle seat belt to secure car seat, lower anchor connectors must be stored.**
- ! Never leave child unattended, even when sleeping. Child may become tangled in harness straps and suffocate or strangle.**
- ! Rear-facing car seat must be properly leveled:**
 - Too reclined can result in injury or ejection.**
 - Too upright can result in breathing difficulties.**



1 Important



! Never attach two lower anchor connectors to one vehicle lower anchor point unless specifically allowed by the vehicle manufacturer.

! Do not use both the vehicle seat belt and lower anchor attachment at the same time when using the car seat forward-facing with the 5-point harness.

! The Seat Belt Trainer is only compatible with the 4EVER® DLX GRAD car seat. DO NOT use with any other car seat.

Car Seat's Useful Life

STOP using this car seat and throw it away 10 years after the date of manufacture. Look for date of manufacture label on back of the car seat. Graco Children's Products Inc. advises against loaning or passing along a car seat unless you know the complete history of the product. We also advise against purchasing a car seat second hand.

Warm Weather Use

Car seat parts can get very hot in the sun or warm weather. **To avoid burns, always check before putting child in car seat.**

1-D Right Mode of Use

4 lb (1.8 kg)	26.5 lb (12 kg)	40 lb (18.1 kg)	65 lb (30 kg)	120 lb (54 kg)
------------------	--------------------	--------------------	------------------	-------------------

Rear-Facing with 5-Point Harness

Must be 49" (125 cm) or less:

4-26.5 lb (1.8-12 kg) less than 1 year old **MUST** be rear-facing.

26.5-40 lb (12-18 kg) **SHOULD** be rear-facing.*

Forward-Facing with 5-Point Harness

Must be 49" (125 cm) or less:

26.5-40 lb (12-18 kg) can sit upright unassisted **CAN** be forward-facing.

40-65 lb (18-30 kg) **SHOULD** be forward-facing.*

Booster Mode with Vehicle Lap/Shoulder Seat Belt

Must be 43-57" (110.1-145 cm) tall and 4+ years old

40-65 lb (18.1-30 kg) **CAN** be in Highback booster mode. 40-65 lb (18.1-30 kg) **CAN** be in Backless booster mode. Over 65 lb (30 kg) **MUST** be in booster or Seat Belt Trainer mode.*

Seat Belt Trainer Mode with Vehicle Lap/

Shoulder Seat Belt Must be 43-60" (110.1-152 cm) tall and 5+ years old 50-65 lb (22.5-30 kg) **CAN** be in Seat Belt Trainer mode.

*Check your state laws and the AAP/NHTSA recommendations. Review page 10 more for information.



1 Important



1 Important

1

Certification

This child restraint meets or exceeds all applicable requirements of Federal motor vehicle safety standards for use in motor vehicles.



This car seat is certified for use in aircraft when using the harness system and without using the lockoff. Use only on forward-facing aircraft seats. Follow the instructions for vehicle installation and section 10-F for routing the aircraft lap belt over the lockoff. For rear-facing installation, see section 3-C and for forward-facing installation, see section 4-C but do not use the tether. See section 10-E “Vehicle Seat Belts” and section 10-F “Aircraft Installation”. Contact the airline for their specific policies.



This car seat is **NOT** certified for use in aircraft when using the lockoff **OR** when used as a booster seat **OR** when used in Seat Belt Trainer mode because aircrafts do not have shoulder belts.

2-A Car Seat Features

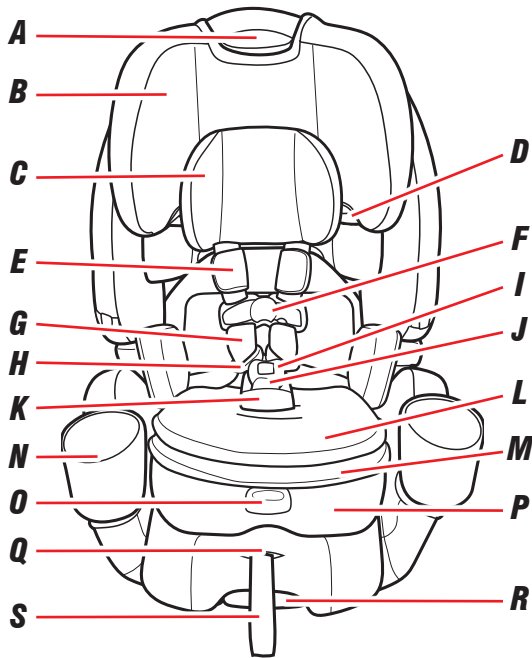

- A** Headrest/Harness Height Adjustment Lever
- B** Headrest
- C** Infant Head Support
- D** Booster Shoulder Belt Guide
- E** Harness Covers
- F** Chest Clip
- G** Harness Straps
- H** Buckle Tongues
- I** Buckle
- J** Buckle Strap
- K** Buckle Cover
- L** Infant Body Support
- M** Seat Insert
- N** Cup Holder
- O** Seat Belt Trainer Release Lever
- P** Seat Belt Trainer
- Q** Harness Adjustment Lever (Under Seat Pad)
- R** Recline Handle
- S** Harness Adjustment Strap



2 Features



2 Features

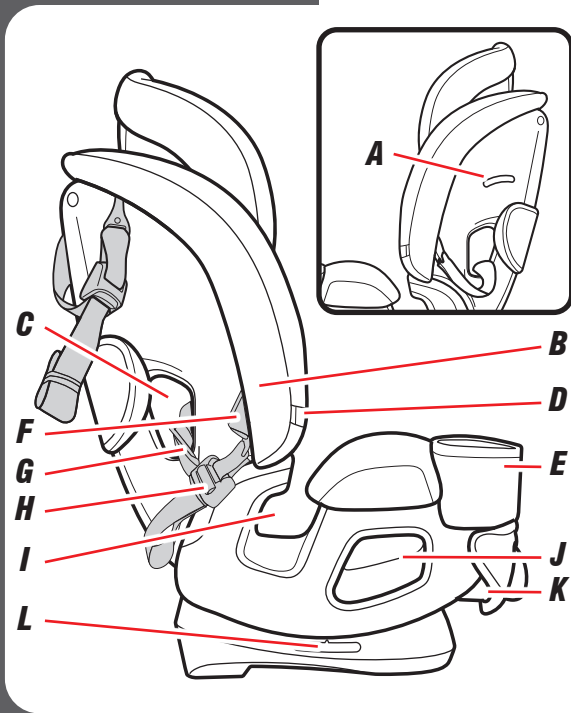

- A** Level Indicator
- B** Forward-Facing Lower Anchor Connector Storage
- C** Forward-Facing Belt Path
- D** Buckle Tongue Storage (Fuss Free Harness)
- E** Cup Holder
- F** Lower Anchor Connectors
- G** Lower Anchor Strap
- H** Lower Anchor Strap Adjuster
- I** Booster Lap Belt Path
- J** Rear-Facing Belt Path
- K** Rear-Facing Lower Anchor Connector Storage (Under Seat)
- L** Recline Position Indicator

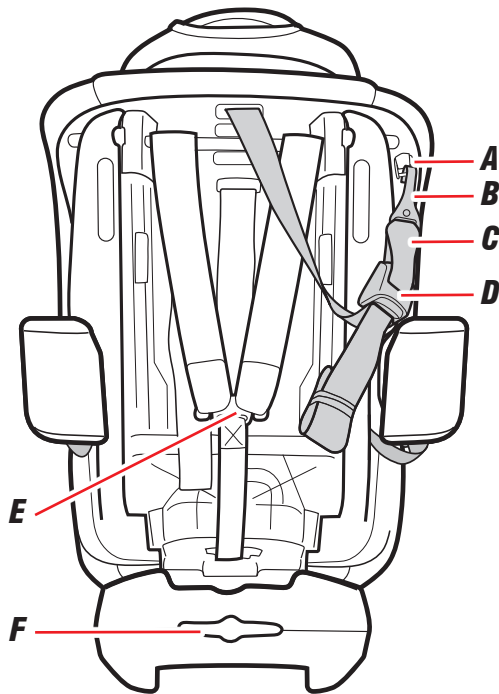

A Tether Storage

B Tether Hook

C Tether Strap

D Tether Strap Adjuster

**E Harness Strap Splitter
Plate**

**F Instruction Manual
Storage**



2 Features



2 Features

With Seat Pads Removed:

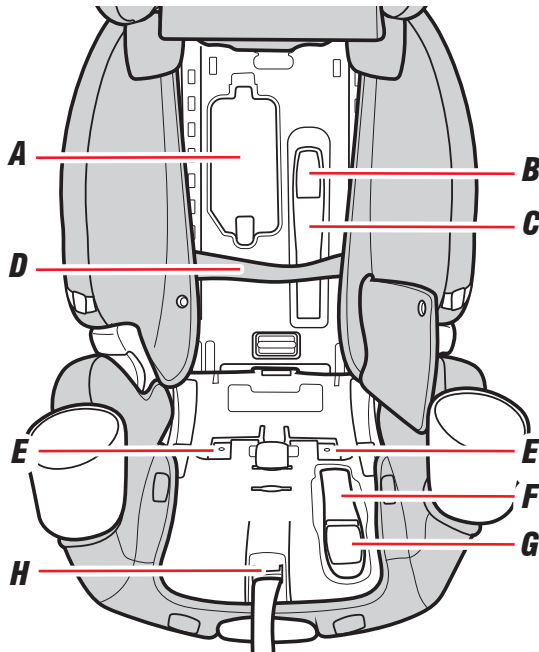

- A*** ***Harness Storage
Compartment***
- B*** ***Forward-Facing
SnugLock® Lock-Off
Release Button***
- C*** ***Forward-Facing
SnugLock® Lock-Off***
- D*** ***Lower Anchor Strap***
- E*** ***Backrest Locks***
- F*** ***Rear-Facing
SnugLock® Lock-Off***
- G*** ***Rear-Facing
SnugLock® Lock-Off
Release Button***
- H*** ***Harness Adjustment
Lever***

Seat Belt Trainer:

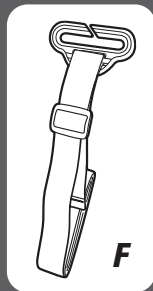
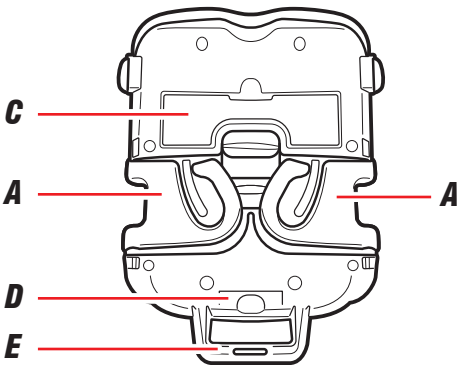
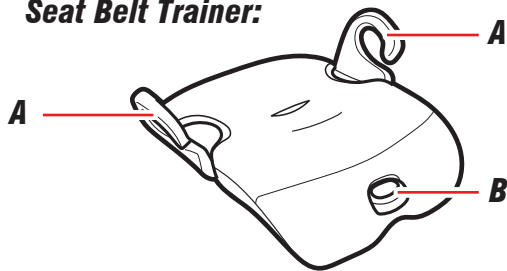

- A Belt Guides***
- B Seat Belt Trainer Release Lever***
- C Belt Positioning Clip Storage***
- D Instruction Manual Storage***
- E Rear Locking Tab***
- F Belt Positioning Clip***



2 Features



3-A Rear-Facing Use

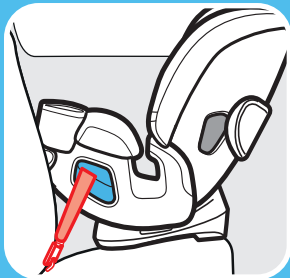

Lower Anchor Attachment

Rear-Facing:
4-40 lb (1.8-18 kg), 49" (125 cm)
or less



- ! Infants who weigh less than 26.5 lb (12 kg) **MUST be rear-facing.**
- ✓ Place car seat rear-facing in the vehicle back seat.
- ✓ Make sure lower anchor strap or vehicle seat belt is routed through the rear-facing belt path marked with a blue label.
- ✓ Install this car seat tightly in your vehicle. Car seat **should not move** at the rear-facing belt path more than 1" (2.5 cm) from side to side, front to back.
- ✓ Check recline level making sure the bubble is within the blue area. Vehicle **MUST** be on level ground.
- ✓ Harness straps need to be **at or just below** the top of child's shoulders and chest clip is at **armpit level.**
- ! **The Seat Belt Trainer MUST be installed when the seat is used in Rear-Facing mode.**

- ✓ Recheck the level indicator with child in seat.
- ! The infant Head and Back Support and the infant Lower Body Support can only be used Rear-Facing for children weighing less than 20 lb (9 kg).
- ! The seat insert **MUST** be installed when using rear facing.
- ! Children are safer riding rear-facing and should ride rear-facing as long as possible, until they reach the maximum rear-facing height or weight rating for their car seat. Then children should ride forward-facing, using the built-in harness system for as long as possible until they reach the maximum forward-facing weight or height for their car seat. Be sure to check your local and state laws, as well as AAP and NHTSA recommendations, for car seat usage.

! WARNING!



NEVER place this child restraint rear-facing in a vehicle seating location that has an active front air bag.



***Vehicle Seat Lap/
Shoulder Belt***

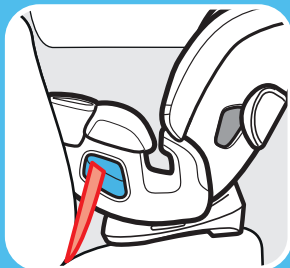

Vehicle Seat Lap Belt

Continue reading on the next page to learn how to install this car seat!



3-B Install Rear-Facing with Lower Anchor Attachment

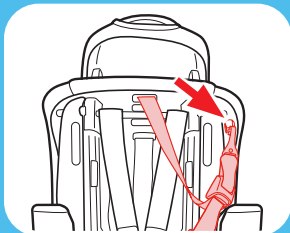

1. Store Tether Strap

Attach tether hook to the plastic bar on the back of the car seat as shown.

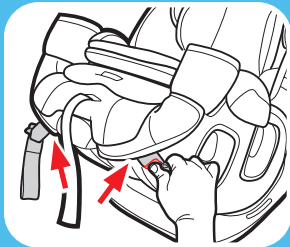

2. Remove Lower Anchor Connectors from Storage Location

Push in on the red buttons on the lower anchor connectors and remove from storage position.

3. **Make Sure the Lower Anchor Strap is in the Rear-Facing Belt Path Marked With a Blue Label**

To move the lower anchor attachment, review section 6.

4. **Recline the Car Seat**

Pull out on handle on front of child restraint and adjust to one of the three rear-facing positions.

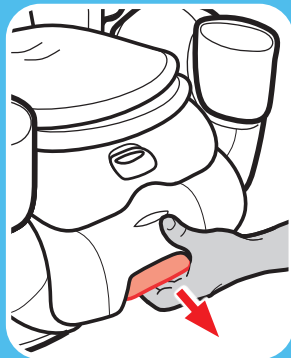
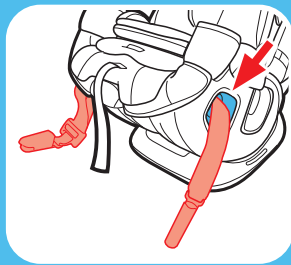
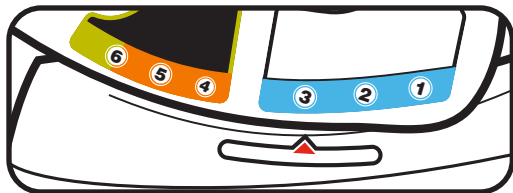

3-B
Rear Facing
with Lower Anchor
Attachment

3-B
Rear Facing
with Lower Anchor
Attachment

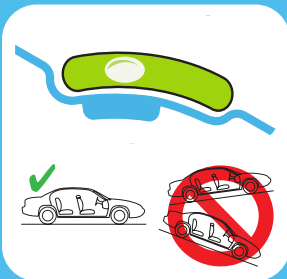
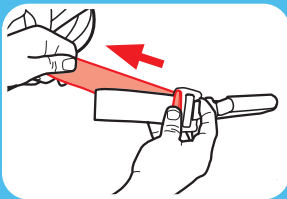

5. Place Car Seat Rear-Facing in Back Seat of the Vehicle

Place rear-facing in vehicle seat and center the car seat between the lower anchors. The base should sit as flat as possible on the vehicle seat.

Note: Make Sure Base is a minimum of 80% on Vehicle Seat.

6. Extend the Lower Anchor Strap

For easier installation, extend the lower anchor strap to its maximum length by pressing the grey button and pulling on the strap.

7. Check the Level Indicator

Vehicle **MUST** be on level ground.

Check the level indicator on the car seat. The **bubble must be completely within** the blue zone.

If needed, rolled towels may be placed under the car seat at the vehicle seat crease, until the bubble is completely in the blue area.

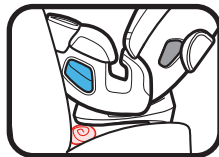

Using With the Belt Lock-Off:

8. Expose the Belt Lock-Off

- A.** Loosen the harness straps.
- B.** Raise the headrest to the highest position.
- C.** Unbuckle the buckle.
- D.** Unbuckle the chest clip.

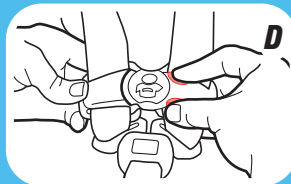
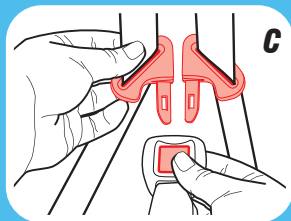
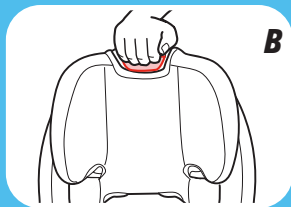
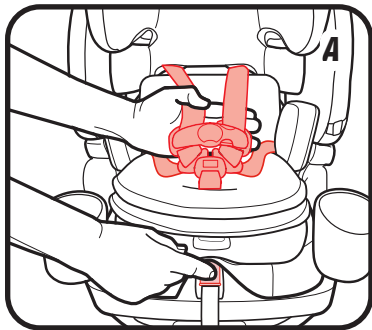

3-B
Rear Facing
with Lower Anchor
Attachment

3-B
Rear Facing
with Lower Anchor
Attachment

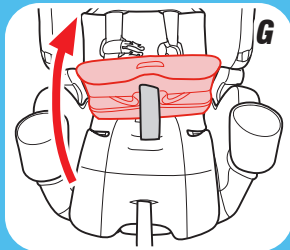
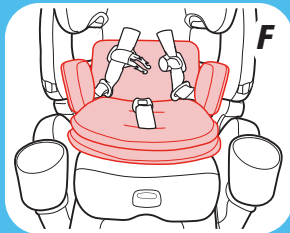
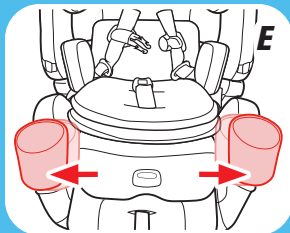

E. Move Cupholders Out

Make sure the cup holders are pushed outward.

F. Remove Infant Body Support and Seat Insert

G. Lift and Remove The Seat Belt Trainer

Pull the lever on the front of the Seat Belt Trainer. Then lift up the Seat Belt Trainer and remove it from the car seat

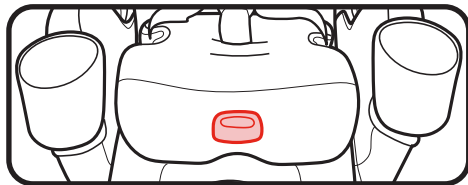

H. Lift The Seat Pad

Lift Bottom Seat Pad Up To Expose the Plastic Shell.

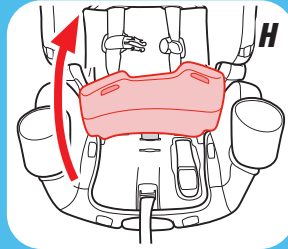

9. Open the SnugLock® Lock-Off

Lift the lever to open the SnugLock® lock-off.

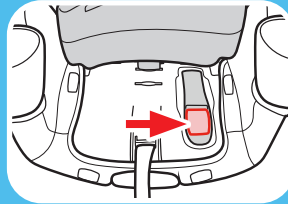

10. Make Sure the Lower Anchor strap is Routed Under the SnugLock® Lock-Off

The lower anchor strap should lie as flat as possible and not be twisted.

Make sure the lower anchor strap is in front of the buckle strap when the buckle is in the inner-most position, and behind when in the outer-most position.

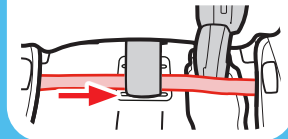
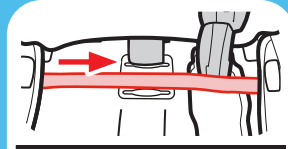

3-B
Rear Facing
with Lower Anchor
Attachment

3-B Rear Facing with Lower Anchor Attachment



11. **Connect the Lower Anchor Connectors to Vehicle's Lower Anchors**

Make sure the arrows are pointing up.

Lower anchor strap should not be twisted. If twisted, you will not be able to tighten the strap.

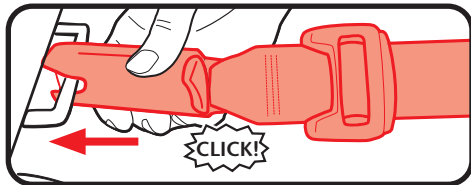
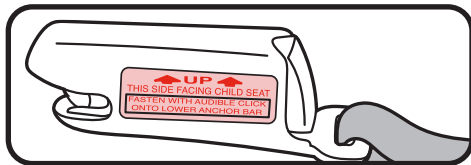

12. Tighten the Lower Anchor Strap

Press down firmly in the center of the car seat while tightening the lower anchor strap. You may need to tighten through the belt path as shown. Do not pull on the strap with excessive force.

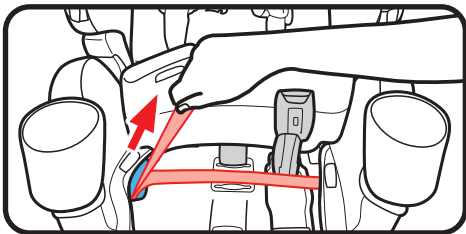

13. Close the SnugLock® Lock-Off

When the slack is removed, close the SnugLock® Lock-Off until you hear a “Click”. Make sure the Lower Anchor strap is under the SnugLock® Lock-Off.

⚠ WARNING!

Keep hands away from the lock-off area when closing the lock-off.

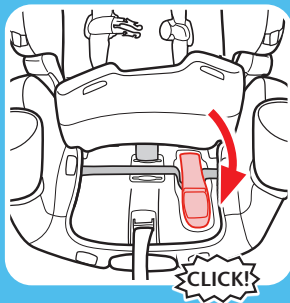
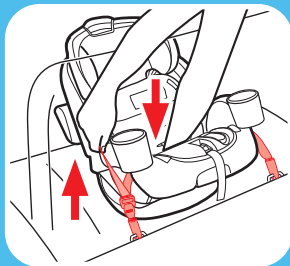

3-B
Rear Facing
with Lower Anchor
Attachment

3-B
Rear Facing
with Lower Anchor
Attachment

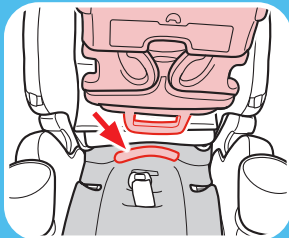
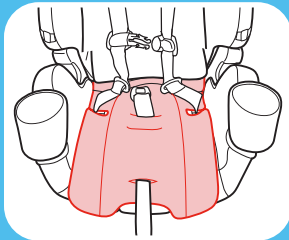
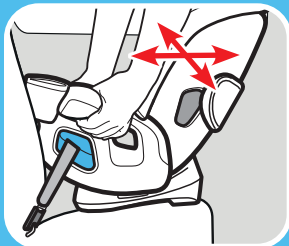

14. Test For Tightness

Grab the sides of the seat where the lower anchor strap is and slide the car seat side-to-side and front-to-back.

If the seat moves less than 1" (2.5 cm), it is tight enough.

15. Replace The Seat Pad

16. Replace The Seat Belt Trainer

The Seat Belt Trainer MUST be installed when the seat is used in Rear-Facing mode.

Insert the locking tab on the rear of the Seat Belt Trainer into the slot near the seat crease on the car seat.

Thread the buckle strap through the **MATCHING** buckle slot in the Seat Belt Trainer.

If the buckle is in the rear slot, you will need to partially open the belt guides.

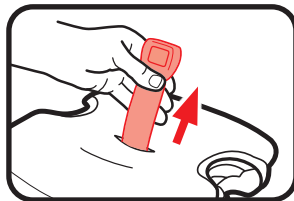

Push the front of the Seat Belt Trainer down on the Seat Base. You will hear a click when it is securely in place.

CHECK that the Seat Belt Trainer is securely attached by pulling up on both sides.

17. Reinstall Infant Body Support and Seat Insert

The seat insert **MUST** be used for children 40 lb (18 kg) or less.

18. Move Headrest

Move the headrest back to its proper position for your child.

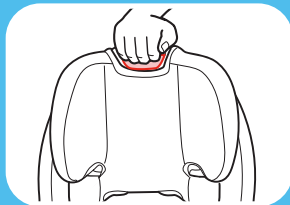
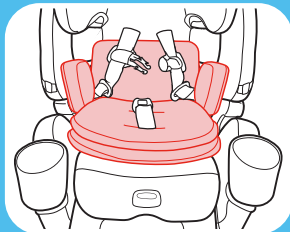
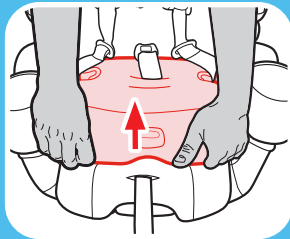

3-B

Rear Facing
with Lower Anchor
Attachment

3-B Rear Facing with Lower Anchor Attachment

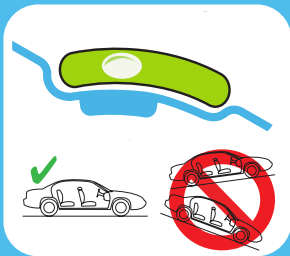

19. Check the Level Indicator

Vehicle **MUST** be on level ground.

Check the level indicator on the car seat. The **bubble must be completely within** the blue zone. Readjust if needed.

See section 5-A to secure your child.

Recheck the level indicator with child in seat.

If needed, rolled towels may be placed under the car seat at the vehicle seat crease, until the bubble is completely in the blue area.

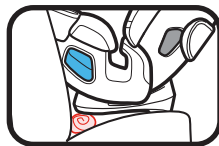

3-C Install Rear-Facing with Vehicle Seat Belt

1. Make Sure the Lower Anchor Strap is in the Forward-Facing Belt Path

To move the lower anchor attachment, review section 6.

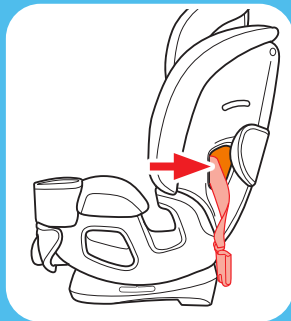

2. Store Tether and Lower Anchor Connectors in Storage Locations

Attach tether hook and lower anchor connectors to the plastic bars as shown.

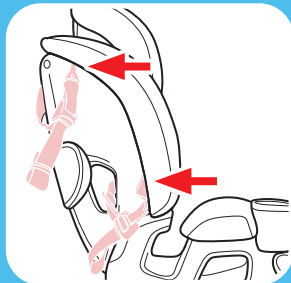

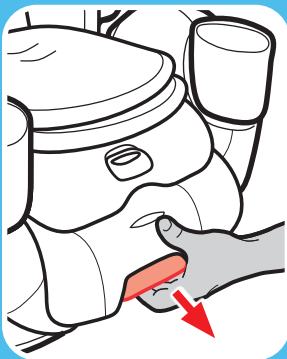

3-C
Rear Facing
with Seat Belt

3-C Rear Facing with Seat Belt

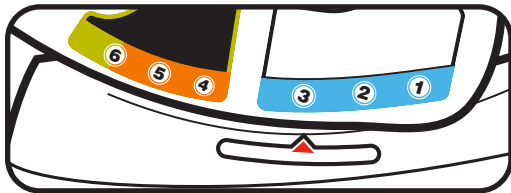

3. Recline the Car Seat

Pull out on handle on front of child restraint and adjust to one of the three rear-facing positions.



4. Place Car Seat Rear-Facing in Back Seat of the Vehicle

Place rear-facing in vehicle seat and center the car seat between the lower anchors. The base should sit as flat as possible on the vehicle seat.

Note: Make Sure Base is a minimum of 80% on Vehicle Seat.

5. Check the Level Indicator

Vehicle **MUST** be on level ground.

Check the level indicator on the car seat. The **bubble must be completely within** the blue zone.

If needed, rolled towels may be placed under the car seat at the vehicle seat crease, until the bubble is completely in the blue area.

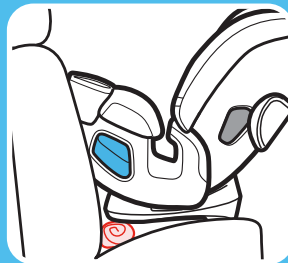
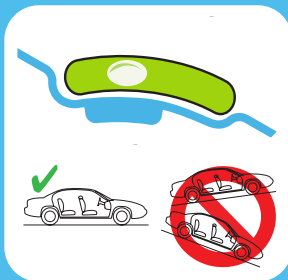

3-C Rear Facing
with Seat Belt

3-C Rear Facing with Seat Belt

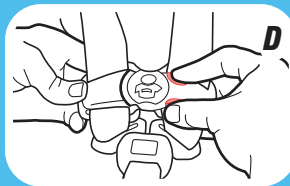
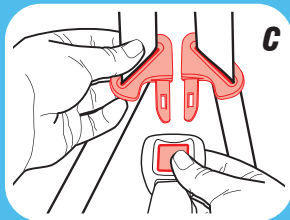
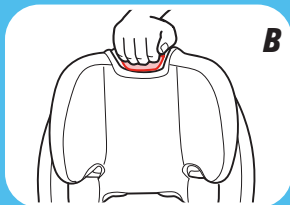

Using With the Belt Lock-Off:

6. Expose the Belt Lock-Off

- A.** Loosen the harness straps.
- B.** Raise the headrest to the highest position.
- C.** Unbuckle the buckle.
- D.** Unbuckle the chest clip.

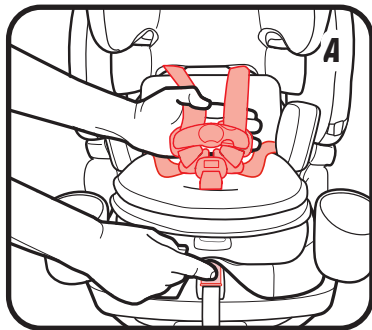

E. Move Cupholders Out

Make sure the cup holders are pushed outward.

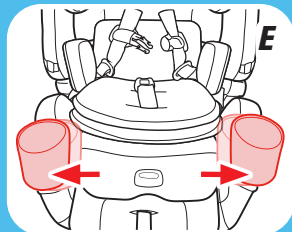

F. Remove Infant Body Support and Seat Insert

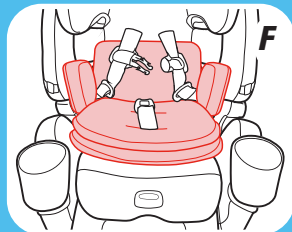

G. Lift and Remove The Seat Belt Trainer

Pull the lever on the front of the Seat Belt Trainer. Then lift up the Seat Belt Trainer and remove it from the car seat.

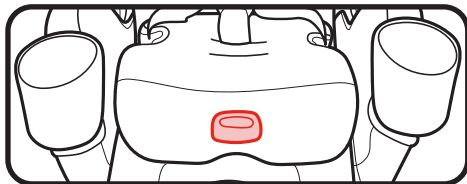

37

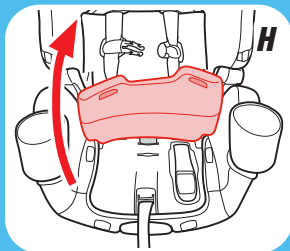

3-C Rear Facing
with Seat Belt

3-C Rear Facing
with Seat Belt

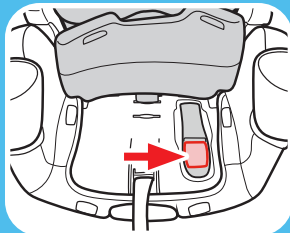

H. Lift The Seat Pad

Lift Bottom Seat Pad Up To Expose the Plastic Shell.



7. Open the SnugLock® Lock-Off

Lift the lever to open the SnugLock® lock-off.

Review your vehicle owner's manual for vehicle seat belt use

8. Route the Vehicle Seat Belt Under the SnugLock® Lock-off

Thread vehicle seat belt through the rear-facing belt path (marked with a blue label), through the SnugLock® Lock-Off, and out the other side. Buckle the seat belt. The seat belt should lie as flat as possible and not be twisted.

Make sure the vehicle seat belt is in front of the buckle strap when the buckle is in the inner-most position, and behind when in the outer-most position.

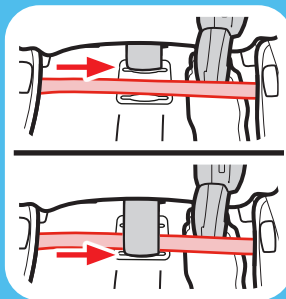
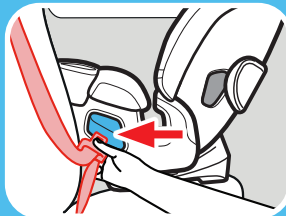

3-C Rear Facing
with Seat Belt

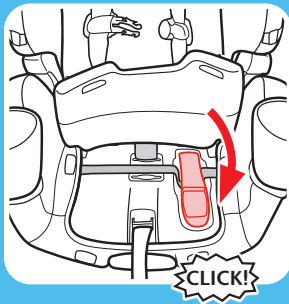
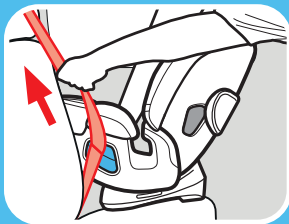

9. Tighten the Vehicle Seat Belt

Press down firmly in the center of the car seat. Pull on the shoulder belt to tighten while feeding the slack back in the retractor. Do not pull on the strap with excessive force.

10. Close the SnugLock® Lock-Off

When the slack is removed, close the SnugLock® Lock-Off until you hear a “Click”. Make sure the vehicle seat belt is under the SnugLock® Lock-Off.

! WARNING!

Keep hands away from the lock-off area when closing the lock-off.

11. **Switch the Retractor**

Switch the retractor after the installation is complete to avoid a possible strangulation risk.

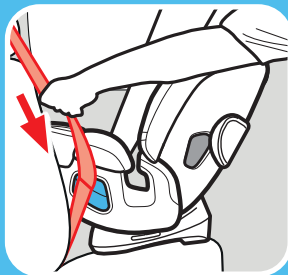

12. **Test For Tightness**

Grab the sides of the seat where the lower anchor strap is and slide the car seat side-to-side and front-to-back.

If the seat moves less than 1" (2.5 cm), it is tight enough.



3-C Rear Facing
with Seat Belt



3-C Rear Facing with Seat Belt

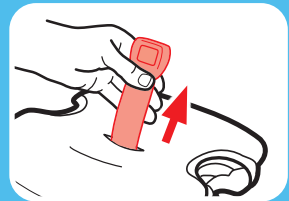
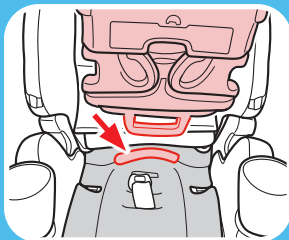
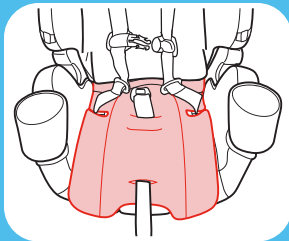

13. Replace The Seat Pad

14. Replace The Seat Belt Trainer

The Seat Belt Trainer MUST be installed when the seat is used in Rear-Facing mode.

Insert the locking tab on the rear of the Seat Belt Trainer into the slot near the seat crease on the car seat.

Thread the buckle strap through the **MATCHING** buckle slot in the Seat Belt Trainer.

If the buckle is in the rear slot, you will need to partially open the belt guides.

Push the front of the Seat Belt Trainer down on the Seat Base. You will hear a click when it is securely in place.

CHECK that the Seat Belt Trainer is securely attached by pulling up on both sides.

15. Reinstall Infant Body Support and Seat Insert

The seat insert **MUST** be used for children 40 lb (18 kg) or less.

16. Move Headrest

Move the headrest back to its proper position for your child.

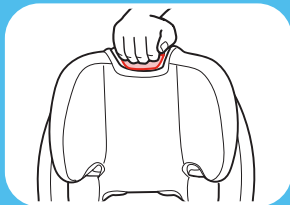
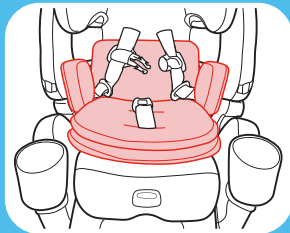
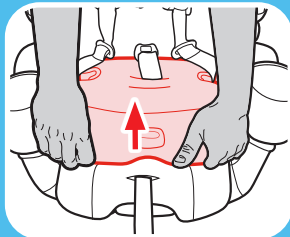

3-C Rear Facing
with Seat Belt

3-C Rear Facing with Seat Belt

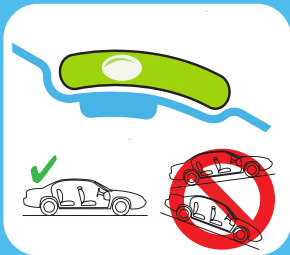

17. Check the Level Indicator

Vehicle **MUST** be on level ground.

Check the level indicator on the car seat. The **bubble must be completely within** the blue zone. Readjust if needed.

See section 5-A to secure your child.

Recheck the level indicator with child in seat.

If needed, rolled towels may be placed under the car seat at the vehicle seat crease, until the bubble is completely in the blue area.

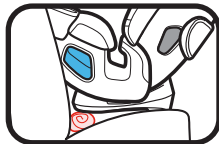

4-A Forward-Facing Use



4-A Forward-Facing

Forward-Facing:
26.5-65 lb (12-30 kg)
49" (125 cm) or less



- ✔ Place car seat forward-facing in the vehicle back seat.
 - ✔ Make sure lower anchor strap or vehicle seat belt is routed through the forward-facing belt path marked with an orange label.
 - ✔ Install this car seat tightly in your vehicle. Car seat **should not move** at the forward-facing belt path more than 1" (2.5 cm) from side to side, front to back.
 - ✔ Harness straps need to be **at or just above** the top of child's shoulders and chest clip is at **armpit level**.
- ! **For children under 40 lb (18 kg), you MUST use recline position 4 or 5.**
 - ! **For children over 40 lb (18 kg), you MUST use recline position 6.**
 - ! **DO NOT use the Seat Belt Trainer with the seat in Forward-Facing mode**



LATCH

Do not install by this method for a child weighing more than 45 lb (20 kg)



4-A Forward-Facing

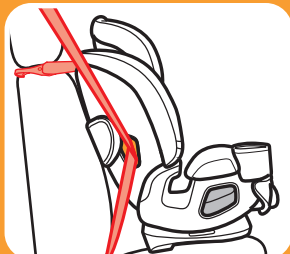

**Vehicle Lap/Shoulder Belt
with Tether Strap**

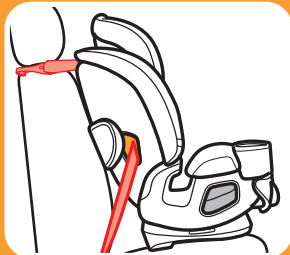

**Vehicle Seat Lap Belt
with Tether Strap**

Continue reading on the
next page to learn how to
install this car seat!

- ! Children are safer riding rear-facing and should ride rear-facing as long as possible, until they reach the maximum rear-facing height or weight rating for their car seat. Then children should ride forward-facing, using the built-in harness system for as long as possible until they reach the maximum forward-facing weight or height for their car seat. At that point, children should ride in a belt-positioning booster seat. Be sure to check your local and state laws, as well as AAP and NHTSA recommendations, for car seat usage.



4-B Install Forward-Facing with LATCH

Review your vehicle owner's manual for LATCH location and use. Do not install by this method for a child weighing more than 45 lb (20 kg).

DO NOT use the Seat Belt Trainer with the seat in Forward-Facing mode

To remove the Seat Belt Trainer, review section 8.

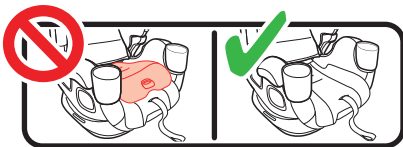

1. Remove Lower Anchor Connectors from Storage Location

Push in on the red buttons on the lower anchor connectors and remove from storage position.

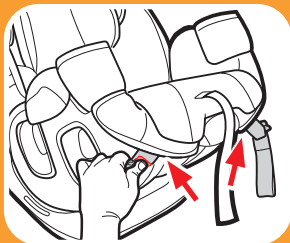

4-B Forward-Facing
with LATCH

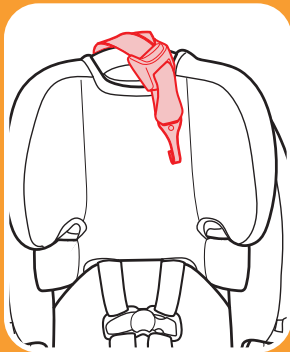
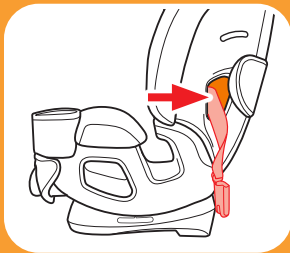

2. Make Sure Lower Anchor Strap is in the Forward-Facing Belt Path

To move the lower anchor attachment, review section 6.

3. Unhook Tether Strap From Storage

Unhook tether and lay it in the seat.

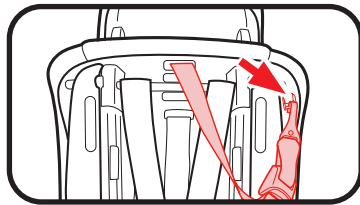

4. Recline the Car Seat

Pull out the recline handle and place the car seat in recline position 4, 5, or 6.

For children under 40 lb (18 kg), you MUST use recline position 4 or 5.

For children over 40 lb (18 kg), you MUST use recline position 6.

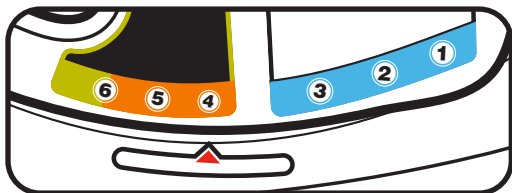

5. Place Car Seat Forward-Facing in Back Seat of the Vehicle

Place forward-facing in vehicle seat and center the car seat between the lower anchors. The base should sit as flat as possible on the vehicle seat.

Note: Make Sure Base is a minimum of 80% on Vehicle Seat.

6. Extend the Lower Anchor Strap

For easier installation, extend the lower anchor strap to its maximum length by pressing the grey button and pulling on the strap.

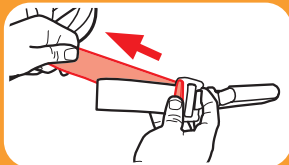
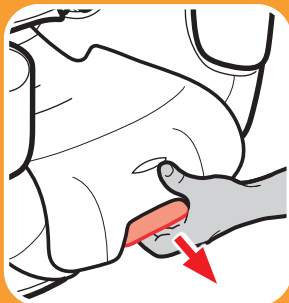

4-B

Forward-Facing
with LATCH

**4-B Forward-Facing
with LATCH**

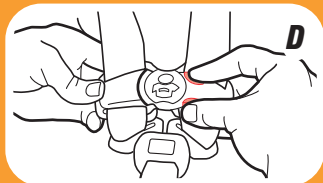
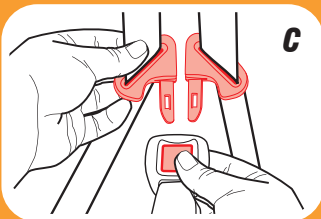
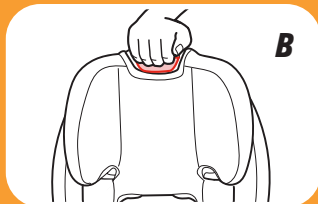

Using With the Belt Lock-Off:

7. Expose the Belt Lock-Off

- A.** Loosen the harness straps.
- B.** Raise the headrest to the highest position.
- C.** Unbuckle the buckle.
- D.** Unbuckle the chest clip.

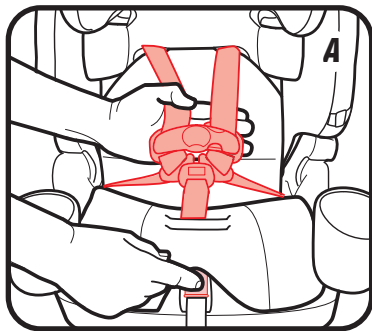

E. Lift the headrest pad flap up out of the way.

8. Open the SnugLock® Lock-Off

Lift the lever to open the SnugLock® lock-off.

9. Make Sure the Lower Anchor Strap is Routed Under the SnugLock® Lock-Off

The lower anchor strap should lie as flat as possible and not be twisted.

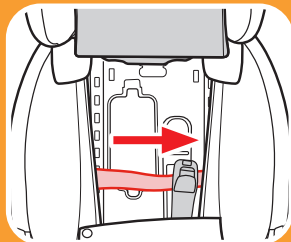
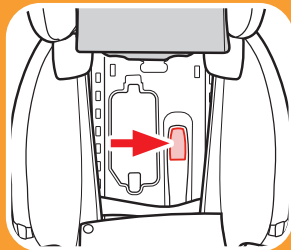
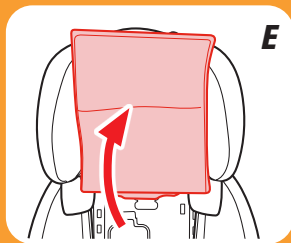

4-B Forward-Facing
with LATCH

4-B Forward-Facing
with LATCH

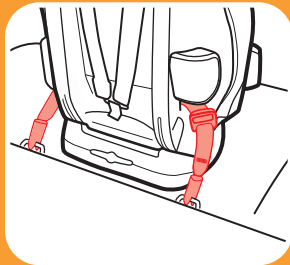
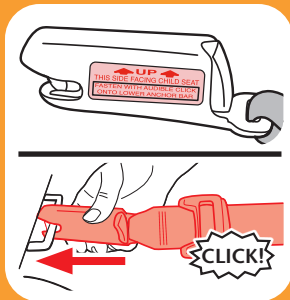

10. Attach Lower Anchor Connectors to Vehicle's Lower Anchors

Make sure the arrows are pointing up.

Lower anchor strap should not be twisted. If twisted, you will not be able to tighten the strap.

11. Tighten the Lower Anchor Strap

Press down firmly in the center of the car seat while tightening the lower anchor strap. You may need to tighten through the slit in the pad at the belt path as shown. Do not pull on the strap with excessive force.

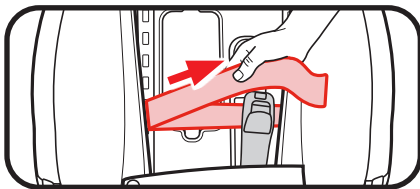

12. Close the SnugLock® Lock-Off

When the slack is removed, close the SnugLock® Lock-Off until you hear a “Click”. Make sure the Lower Anchor strap is under the SnugLock® Lock-Off.

! WARNING!

Keep hands away from the lock-off area when closing the lock-off.

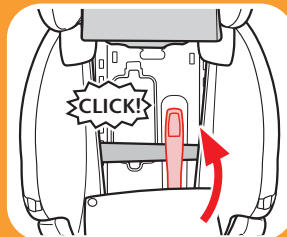
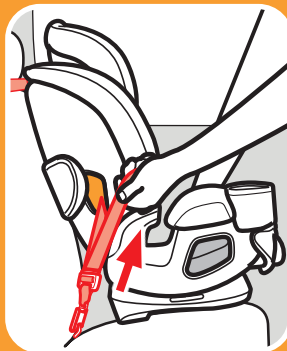

4-B

Forward-Facing
with LATCH

4-B Forward-Facing with LATCH

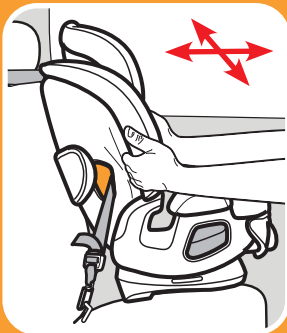
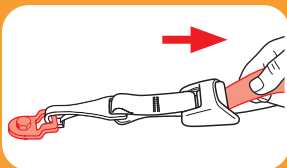
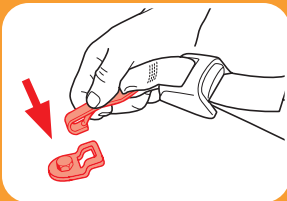

13. **Attach Tether Strap**

Extend the tether by pressing the grey button and pulling out on the strap and attach.

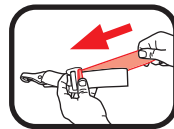

Consult vehicle's owner manual for specific location.

14. **Tighten Tether Strap**

Remove all the slack.

15. **Test For Tightness**

Grab the sides of the seat where the lower anchor strap is and slide the car seat side-to-side and front-to-back.

If the seat moves less than 1" (2.5 cm), it is tight enough.

See section 5-A to secure your child.

16. **Replace the Seat Pad**

Move the headrest back to its proper position for your child.

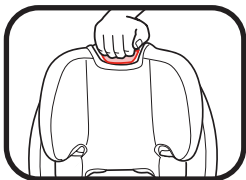

17. **Reinstall Seat Insert**

The seat insert **MUST** be used for children 40 lb (18 kg) or less.

The seat insert **MUST** be removed for children over 40 lb (18 kg).

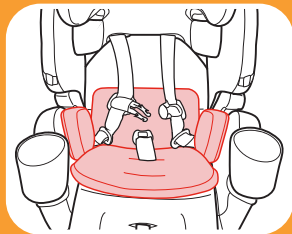

4-B Forward-Facing
with LATCH

4-C Install Forward-Facing with Vehicle Seat Belt

DO NOT use the Seat Belt Trainer with the seat in Forward-Facing mode

To remove the Seat Belt Trainer, review section 8.

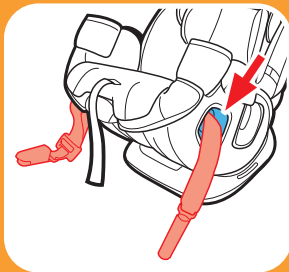
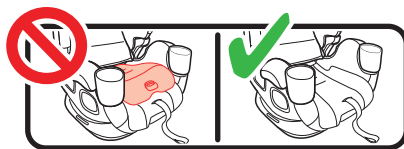

- 1. Make Sure Lower Anchor Strap is in the Rear-Facing Belt Path Marked With a Blue Label**

If not, See section 6 to move lower anchor attachment.

2. Store Lower Anchor Connectors

Attach lower anchor connectors to the plastic bars as shown.

3. Unhook Tether Strap From Storage

Unhook tether and lay it in the seat.

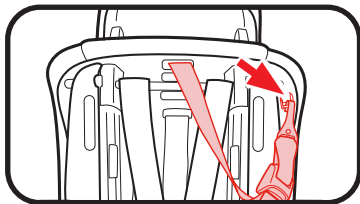

4. Place Car Seat Forward-Facing in Back Seat of the Vehicle

Place forward-facing in vehicle seat. The base should sit as flat as possible on the vehicle seat.

Note: Make Sure Base is a minimum of 80% on Vehicle Seat.

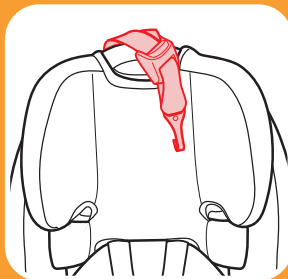
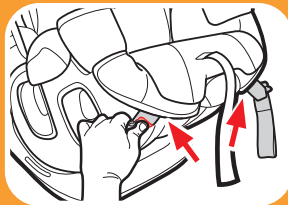

4-C Forward-Facing
with Seat Belt

4-C Forward-Facing with Seat Belt

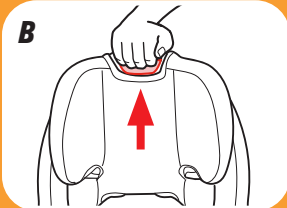
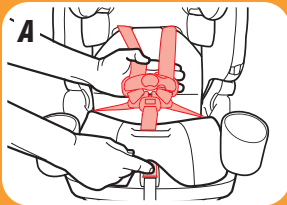
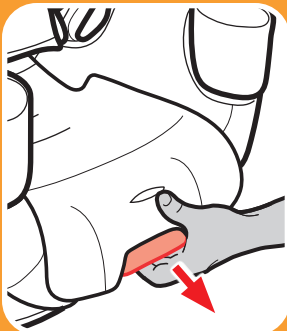

5. Recline the Car Seat

Pull out the recline handle and place the car seat in recline position 4, 5, or 6.

For children under 40 lb (18 kg), you **MUST** use recline 4 or 5.

For children over 40 lb (18 kg), you **MUST** use recline position 6.

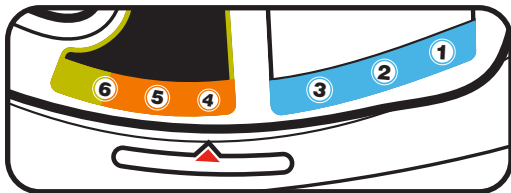

Using With the Belt Lock-Off:

6. Expose the Belt Lock-Off

A. Loosen the harness straps.

B. Raise the headrest to the highest position.

C. Unbuckle the chest clip.

D. Unbuckle the buckle.

E. Lift the headrest pad flap up out of the way.

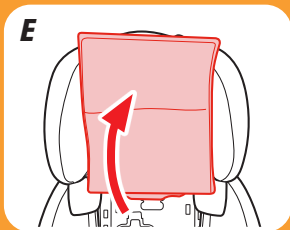
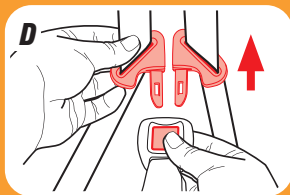
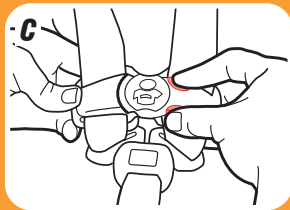

4-C Forward-Facing with Seat Belt

4-C
Forward-Facing
with Seat Belt

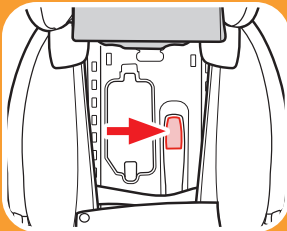

Review your vehicle owner's manual for vehicle seat belt use

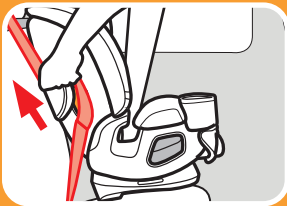
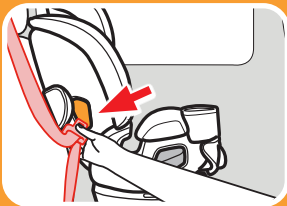

7. Open the SnugLock® Lock-Off

Lift the lever to open the SnugLock® lock-off.

8. Route the Vehicle Seat Belt

Thread vehicle seat belt through the forward-facing belt path (marked with an orange label), through the lock-off, and out the other side. Buckle the seat belt.

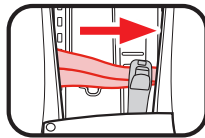

The seat belt should lie as flat as possible and not be twisted.

9. Tighten the Vehicle Seat Belt

Press down firmly in the center of the car seat. Pull on the shoulder belt to tighten while feeding the slack back in the retractor. Do not pull on the strap with excessive force.

10. Close the SnugLock® Lock-Off

When the slack is removed, close the SnugLock® Lock-Off until you hear a “Click”. Make sure the vehicle seat belt is under the SnugLock® Lock-Off.

⚠ WARNING!

Keep hands away from the lock-off area when closing the lock-off.

11. Switch the Retractor

Switch the retractor after the installation is complete to avoid a possible strangulation risk.

12. Attach Tether Strap

Extend the tether by pressing the grey button and pulling out on the strap and attach. Consult vehicle’s owner manual for specific location.

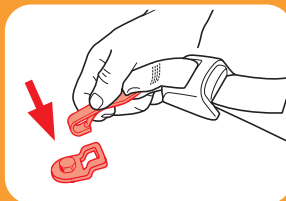
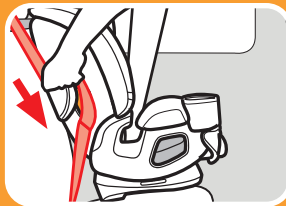
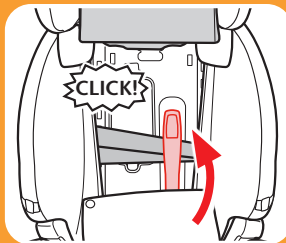
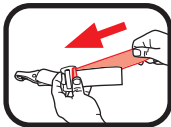

4-C Forward-Facing
with Seat Belt

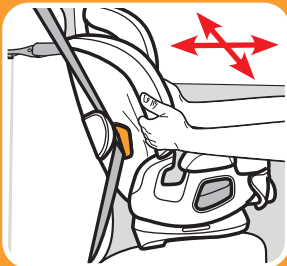
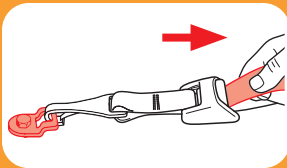

13. Tighten the Tether Strap

Push the car seat back while tightening the tether strap to remove all the slack.

14. Test For Tightness

Grab the sides of the seat where the vehicle seat belt is and slide the car seat side-to-side and front-to-back.

If the seat moves less than 1" (2.5 cm), it is tight enough.

See section 5-A to secure your child.

15. Replace the Seat Pad and Seat Insert

The seat insert **MUST** be used for children 40 lb (18 kg) or less.

The seat insert **MUST** be removed for children over 40 lb (18 kg).

Move the headrest back to its proper position for your child.

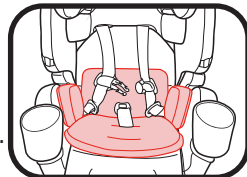

! WARNING!

WARNING! In cold weather, do not put snowsuits or bulky garments on your child when placing them in the car seat. Bulky clothing can prevent the harness straps from being tightened properly. To keep child warm, buckle your child in the car seat and place a blanket around the child or place the child's coat on backwards after buckling in.



5 Securing Child 5-Point Harness

5-A Securing Child 5-Point Harness

1. Loosen Harness Straps

(A) Lift up on the harness release lever while pulling out on the harness straps at the chest clip.

(B) Unbuckle the chest clip and the buckle. **(C)** Place harness straps off to the sides.

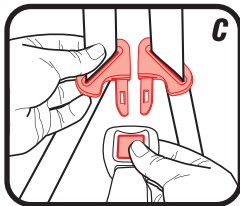

63

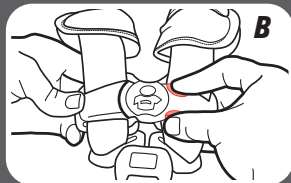
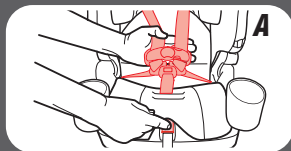

5 Securing Child 5-Point Harness

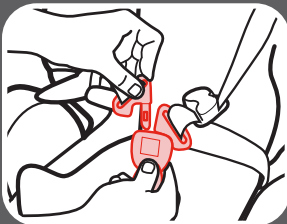
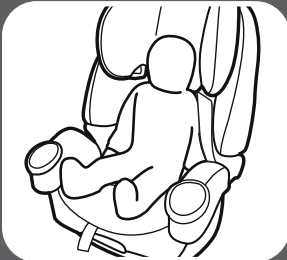
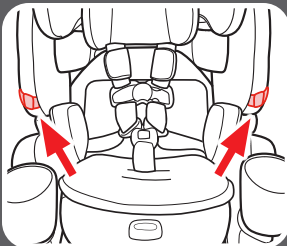

2. Buckle Tongue Storage Pockets

Place buckle tongues in the buckle tongue storage pockets on both sides of the seat.

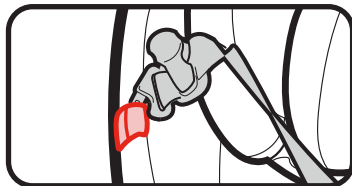

3. Place Your Child in the Seat

Make sure their back is flat against the car seat back.

4. Place Harness Straps Over Child's Shoulders and Buckle

You will hear a “click” when buckle tongues are securely attached. Pull up on each buckle tongue to make sure it is securely attached.

5. Be Sure the Harness Straps Are at the Proper Height

Rear-Facing: Harness straps must be **at or just below** the child's shoulders and top of head **must be at least 1" (2.5 cm) below** the headrest/harness adjustment handle.

Forward-Facing: Harness straps must be **at or just above** the child's shoulders and top of child's ears must be **below** top of headrest.

Remove any head and body supports.

6. To Raise or Lower Headrest/Harness

Squeeze the adjustment lever and lift or lower headrest for the proper harness height.

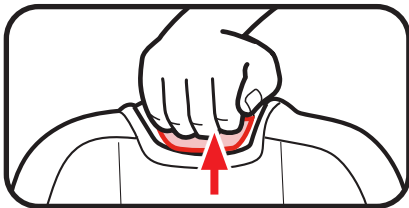

Rear-Facing



Forward-Facing

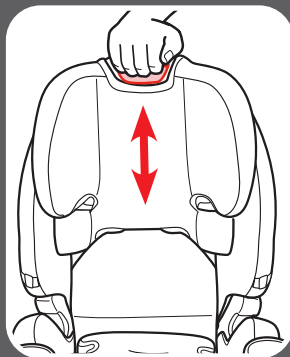

5 Securing Child
5-Point Harness

5 Securing Child 5-Point Harness

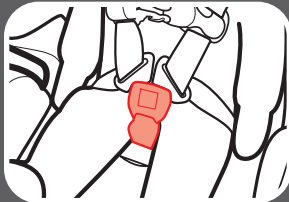
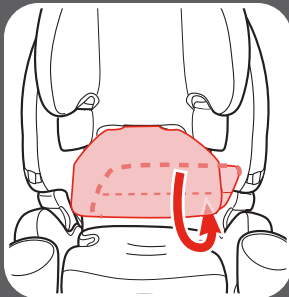

7. Adjust the Seat Pad

The headrest flap has 3 folding positions, shorten headrest by folding the bottom of the flap under itself as shown.

When raising the headrest, make sure to unfold the flap as needed.

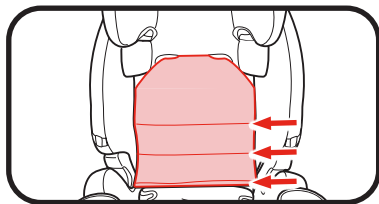

8. Check the Buckle Position

The correct slot is the one that is closest to your child without being underneath your child.

9. To Adjust Buckle Strap (skip to step 12 if not needed)

Recline the car seat to recline position 1 and locate the metal retainer under the car seat shell.

10. Rotate Metal Retainer and Insert It Up Through the Shell, Pad and Seat Belt Trainer

From the top of the car seat, pull the buckle out.

Note: If the buckle is in the rear slot, you will need to lift the trainer and partially open the belt guides.

11. Re-threading the buckle

Note: If threading through the forward slot, you may need to move the lower anchor strap aside.

Without the Seat Belt Trainer: Reach underneath the car seat and pull the metal retainer through.

With the Seat Belt Trainer: Pull the lever on the front of the Seat Belt Trainer and lift up the Seat Belt Trainer.

Pull the retainer through the new slot of the seatbelt trainer and then pull through the corresponding slot on the shell.

If threading through the rear slot, you will need to partially open the belt guides before threading the retainer. After threading, close the guides and reattach the trainer.

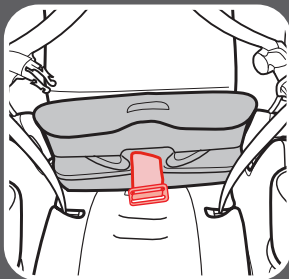
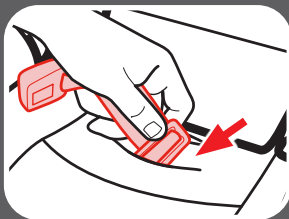
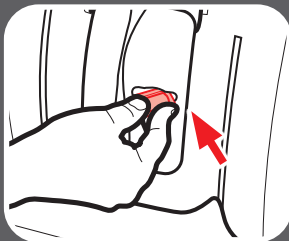

5 Securing Child 5-Point Harness

5 Securing Child 5-Point Harness

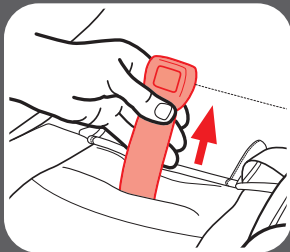

WARNING! : If the Seat Belt Trainer is installed, then the buckle strap **MUST** be inserted through the matching slot in the car seat and the Seat Belt Trainer.

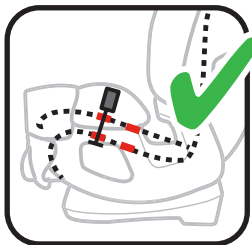

12. Pull Up on Buckle Strap to Make Sure it is Secured

Rear-Facing: Make sure the lower anchor strap is in front of the buckle strap when the buckle is in the inner-most position (A), and in behind when in the outer-most position (B) and that it is flat and is not twisted.

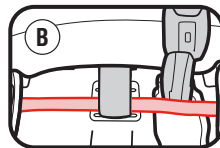
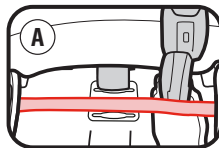

To Shorten Buckle:

Note: The seatbelt trainer MUST be removed when shortening the crotch strap.

To shorten the crotch strap for low birth weight children or to get a better fit, route the crotch strap clip into the opposite slot in the shell. Do not insert the clip into the seat pad.

The crotch strap retainer should remain flat against the seat shell.

13. Buckle the Chest Clip

You will hear a “click” when the chest clip is securely buckled.

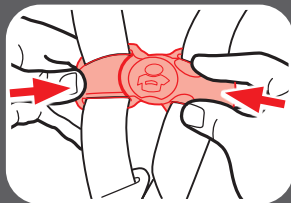
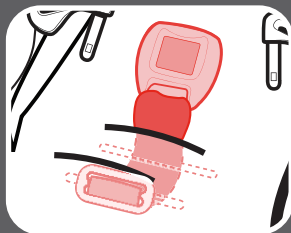
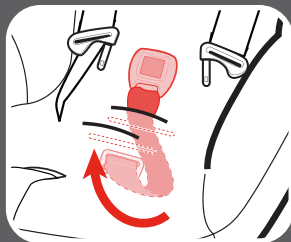

5 Securing Child 5-Point Harness

5 Securing Child 5-Point Harness

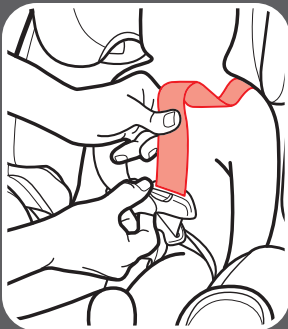

14. Pull All the Slack Out From Around the Waist

Pull up on the harness strap while pushing the chest clip down. Do this to both sides.

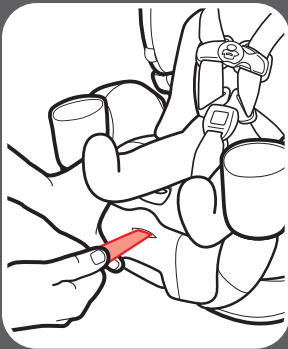

15. Tighten the Harness by Pulling the Harness Adjustment Strap

When you are not able to pinch any of the harness webbing at your child's shoulder, the harness is tight enough.

A snug harness should not allow any slack. It lies in a relatively straight line without sagging. It does not press on the child's flesh or push the child's body into an unnatural position.

16. Raise the Chest Clip to Child's Armpit Level

17. Check Tightness Again, Tighten More if Needed

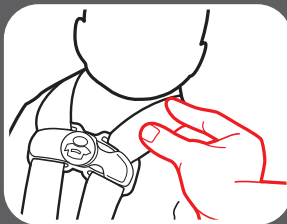
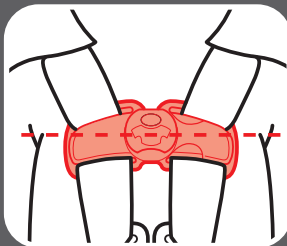
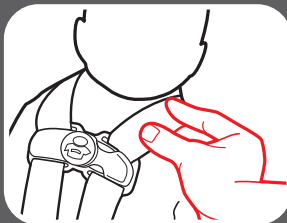

**5 Securing Child
5-Point Harness**



6-A Moving the Lower Anchor Attachment

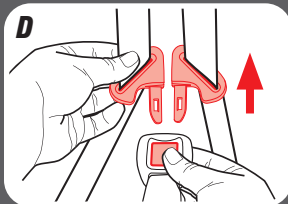
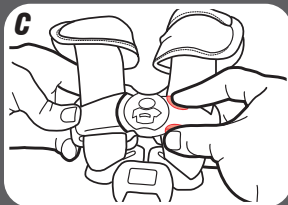
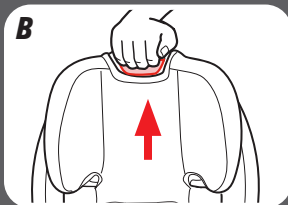

1. For Ease of Moving the Lower Anchor Attachment

- A.** Loosen the harness straps.
- B.** Raise the headrest to the highest position.
- C.** Unbuckle the chest clip.
- D.** Unbuckle the buckle.

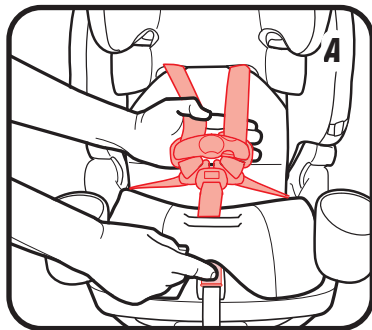

E. Move Cupholders Out

Make sure the cup holders are pushed outward.

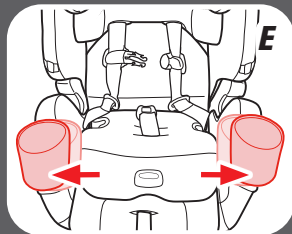

F. Remove The Seat Belt Trainer

Pull the lever on the front of the Seat Belt Trainer. Then lift up the Seat Belt Trainer and remove it from the car seat.

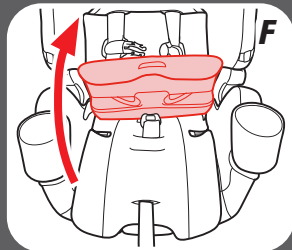
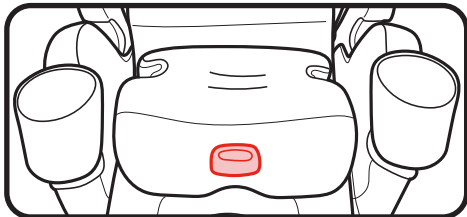

6 Moving
Lower Anchor Attachment

6 Moving Lower Anchor Attachment

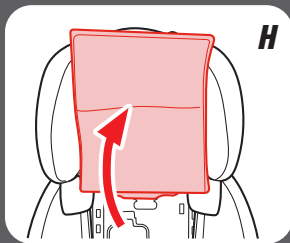
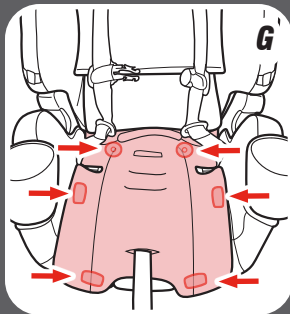

G. Remove the Bottom Seat Pad

Undo the four fastening strips underneath the seat pad. Then pull out the two plugs underneath the seat pad and near the seat crease.

H. Lift the headrest pad flap up out of the way.

1. Move Backrest Pad

Undo the snap on the top corner of the seat pad back, then move the fabric aside.

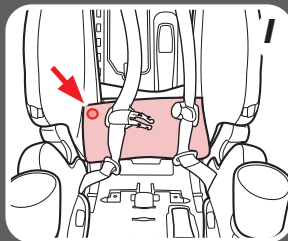

2. Pull the Lower Anchor Connectors Out of the Belt Path Openings

Pull the lower anchor connectors out of the belt path openings, so that the lower anchor connectors lay in the seat.

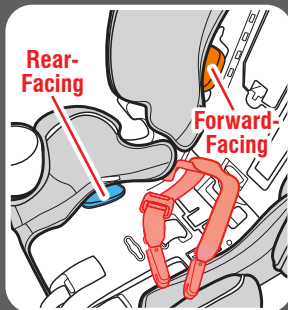

6 Moving
Lower Anchor Attachment

6 Moving Lower Anchor Attachment

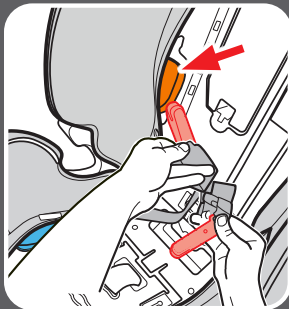
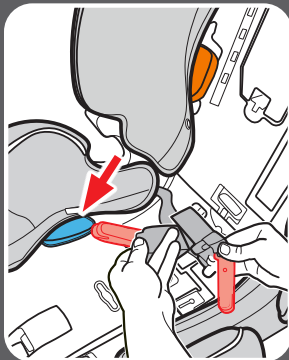

3. Push the Lower Anchor Connectors Out Through the Desired Belt Path Openings on Each Side of Car Seat

Rear-Facing: Make sure the Lower Anchor strap is in front of the buckle strap when the buckle is in the inner-most position (A), and behind when in the outer-most position (B) and that it is flat and is not twisted.

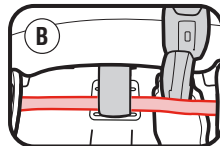
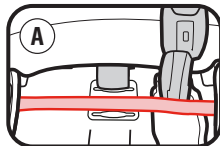

Forward-Facing: Make sure the lower anchor strap is routed behind the harness strap, is flat, and is not twisted.

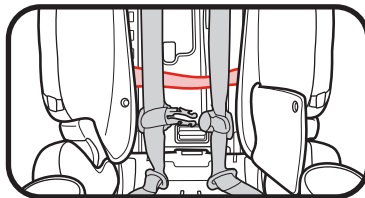

4. Replace the Seat Pads

5. Replace the Seat Belt Trainer

The Seat Belt Trainer **MUST** be installed when the seat is used in Rear-Facing mode.

DO NOT use the Seat Belt Trainer with the seat in Forward-Facing or Booster mode.

To install or remove the Seat Belt Trainer, review section 8.

6. Move the Headrest to Its Proper Position for Your Child

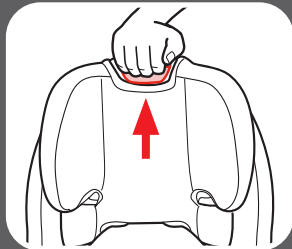
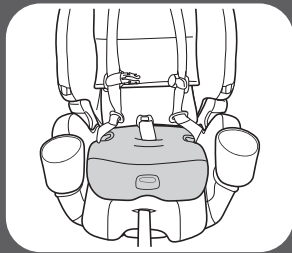
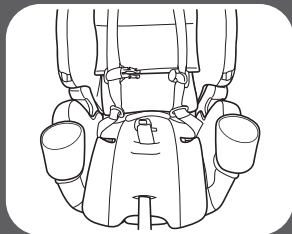

6 Moving
Lower Anchor Attachment



7-A Booster

7-A Booster Use

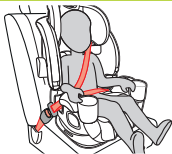

Highback Booster:
40-100 lb (18.1-45 kg)
43-57" (110.1-145 cm)
at least 4 years old

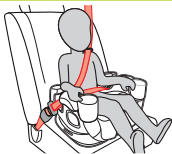

Backless Booster:
40-120 lb (18.1-54 kg)
43-57" (110.1-145 cm)
at least 4 years old



Seat Belt Trainer:
50-120 lb (22.5-54 kg)
43-60" (110.1-152 cm)
at least 5 years old



Vehicle Lap/Shoulder Belt

Continue reading on the next page to learn how to install this car seat!

- ✓ Place car seat forward-facing in the vehicle back seat.
 - ✓ Make sure vehicle seat's lap belt is adjusted snugly and lays low on the child's hip and is routed behind the armrest in the booster's belt path marked with a green label or in front of the belt guides in seat belt trainer mode.
- ! Vehicle belts **MUST** lie flat against child and **MUST NOT** be twisted.



7-A Booster

✔ Vehicle seat's shoulder belt is adjusted snugly and should lie between child's neck and edge of shoulder.

! **Never** use a vehicle lap-only belt across front of child.

! **DO NOT** position vehicle shoulder belt under the child's arm or back.

! **DO NOT** allow child to slouch or slide down in the booster seat.

! **DO NOT** position vehicle belt over top of armrests or over the top the belt guides in seat belt trainer mode.

✔ Vehicle's seat headrest **SHOULD NOT** create a gap between vehicle seat and booster seat.

✔ The front of booster seat **MUST NOT** hang over front of vehicle seat.

! If child will not keep vehicle belt properly positioned, **DO NOT** use this booster seat. Use a different car seat.

When forward-facing, children should use the built-in harness system for as long as possible until they reach the maximum forward-facing weight or height for their car seat. At that point, children should ride in a belt-positioning booster seat. A booster is no longer needed once the vehicle seat belt fits properly, typically when they reach 4 feet 9 inches (145 cm) tall and are between ages 8-12. Be sure to check your local and state laws, as well as AAP and NHTSA recommendations, for car seat usage.



Never Use a Vehicle Lap-Only Belt Across Front of Child in All Booster Modes

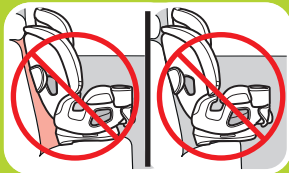



7-B Install Highback Booster

7-B Install Highback Booster

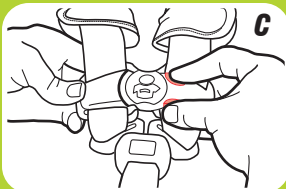
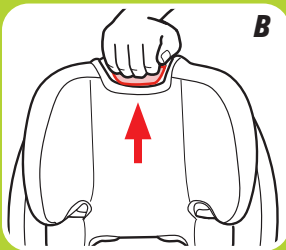
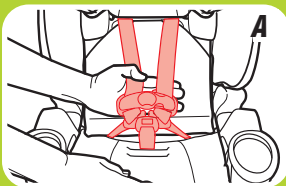

1. Store The Harness System

- A. Loosen the shoulder straps as much as possible.**
- B. Raise the headrest to the highest position.**
- C. Unbuckle the chest clip and the buckle strap (D).**

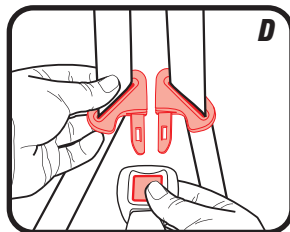

E. Remove Seat Insert

If the Seat Insert is installed, it must be removed to use the seat in Booster mode.

To remove, pull out the pins on each side.

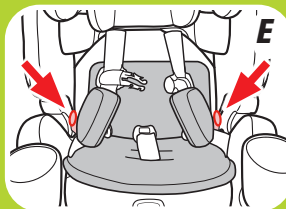

7-B
Install Highback
Booster

F. Move Cupholders Out

Make sure the cup holders are pushed outward.

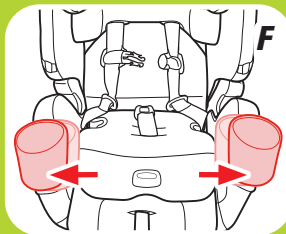

G. Remove The Seat Belt Trainer

DO NOT use the Seat Belt Trainer with the seat in Highback Booster mode.

Pull the lever on the front of the Seat Belt Trainer. Then lift up the Seat Belt Trainer and remove it from the car seat.

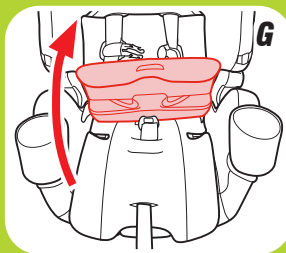
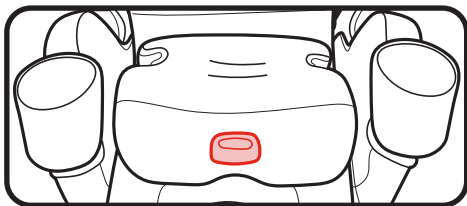

7-B Install Highback Booster

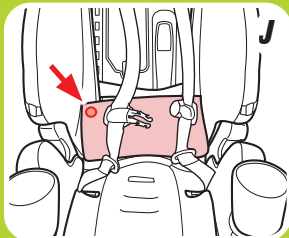
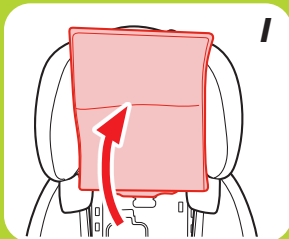
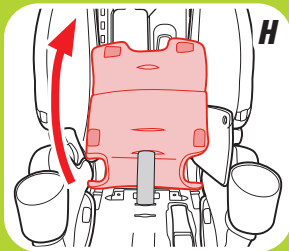

H. Lift The Seat Pad

Remove the seat pad to expose the plastic shell.

I. Lift the headrest pad flap up out of the way.

J. Move Backrest Pad

Undo the snap on the top corner of the seat pad back, then move the fabric aside.

K. Open the Harness Storage Door

L. Place Harness, Chest Clip, Buckle Tongues, Harness Covers Inside Storage Compartment and Close the Door

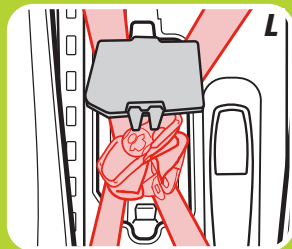
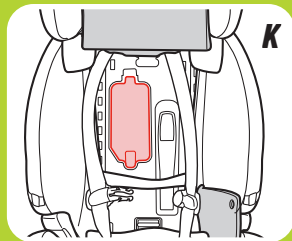
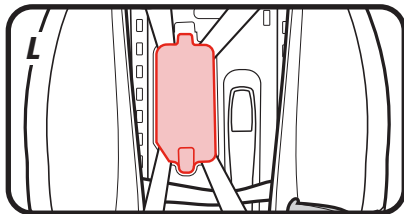

7-B Install Highback
Booster

7-B Install Highback Booster

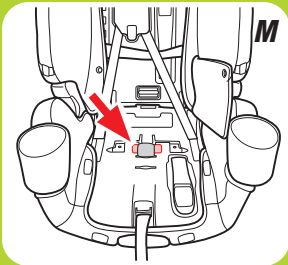
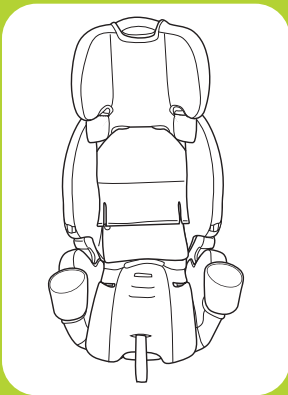

M. Store Buckle inside the slot in the car seat shell as shown

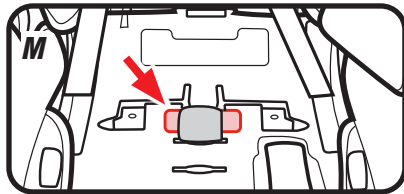

2. Replace the Seat Pad

3. Move the Headrest to Its Proper Position for Your Child

4. Recline the Car Seat

Place car seat in recline position 6.

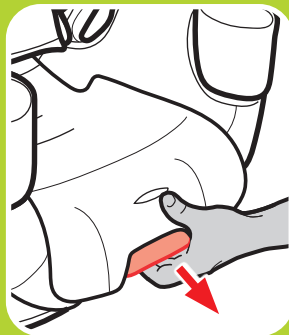
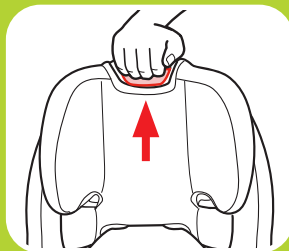
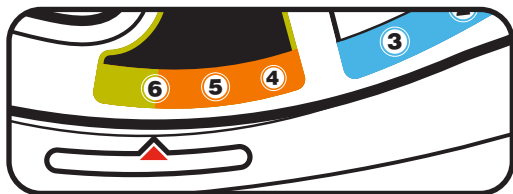

7-B Install Highback
Booster

7-B Install Highback Booster



5. Place the Booster Seat Forward-Facing in the Back Seat of Vehicle

Place forward-facing on a vehicle seat that has a lap/shoulder seat belt. The base should sit as flat as possible on the vehicle seat.

Graco allows the securing of the car seat with LATCH in the booster mode, only if the vehicle manufacturer allows it. The child still **MUST BE SECURED** with the vehicle lap/shoulder seat belt. LATCH can be used in the booster mode regardless of the weight of the child up to 100 lb (45 kg).

Verify the following before using LATCH in the booster mode:

- The lower anchor connectors **DO NOT** interfere with any vehicle seat belts or buckles.
- If securing the car seat in booster mode, the lower anchor connectors and the tether **MUST** be used together.

If the lower anchor connector interferes with the vehicle seat belts or if the chosen seating position does not have lower anchors, you **MUST** store the lower anchor connectors. Store the lower anchor connectors by pushing in on the red buttons on the connectors and attach to the plastic bar as shown. Store the tether strap as shown. Always secure car seat with lower anchor attachment or a vehicle seat belt and tether, even when unoccupied. In a crash, an unsecured car seat can injure passengers.

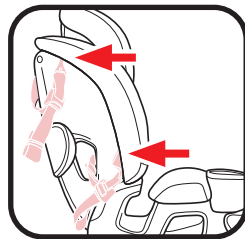



7-B Install Highback Booster

Skip to Step 20 if Not Using LATCH

6. Remove Lower Anchor Connectors from Storage Location

Push in on the red buttons on the lower anchor connectors and remove from storage position.

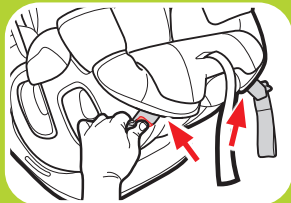

7. Make Sure Lower Anchor Strap is in the Forward-Facing Belt Path

To move the lower anchor attachment, review section 6.

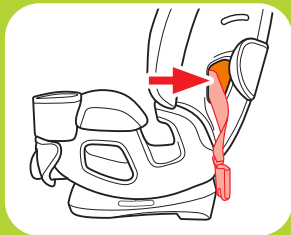

7-B Install Highback Booster

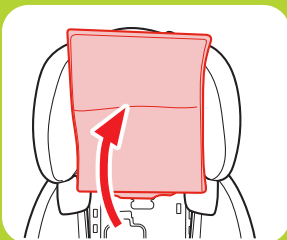
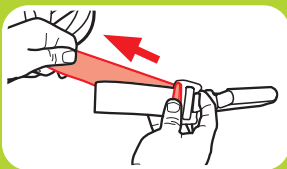
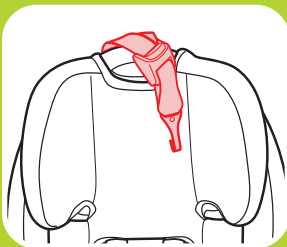

8. Unhook Tether Strap From Storage

Unhook tether and lay it in the seat.

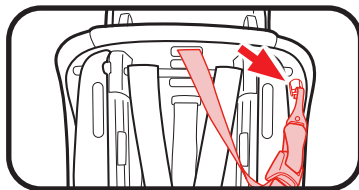

9. Extend the Lower Anchor Strap

For easier installation, extend the lower anchor strap to its maximum length by pressing the grey button and pulling on the strap.

10. Lift the headrest pad flap up out of the way.

11. Open the SnugLock® Lock-Off

Lift the lever to open the SnugLock® lock-off.

12. Make Sure the Lower Anchor Strap is Routed Under the SnugLock® Lock-Off

The lower anchor strap should lie as flat as possible and not be twisted.

13. Attach Lower Anchor Connectors to Vehicle's Lower Anchors

Make sure the arrows are pointing up.

Lower anchor strap should not be twisted. If twisted, you will not be able to tighten the strap.

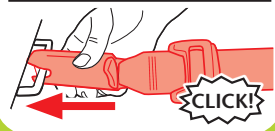
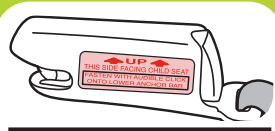
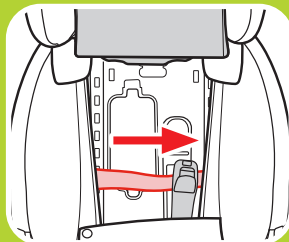
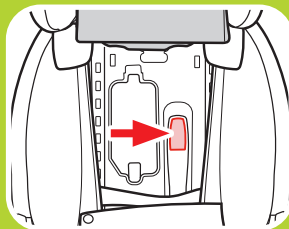

7-B Install Highback Booster

7-B Install Highback Booster

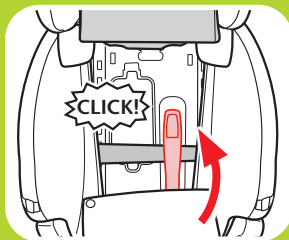
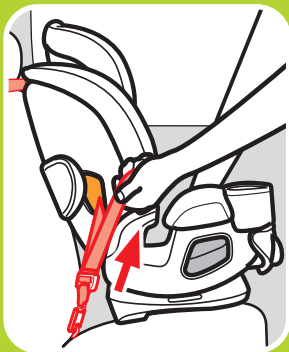

14. Tighten the Lower Anchor Strap

Press down firmly in the center of the car seat while tightening the lower anchor strap. You may need to tighten through the slit in the pad at the belt path as shown. Do not pull on the strap with excessive force.

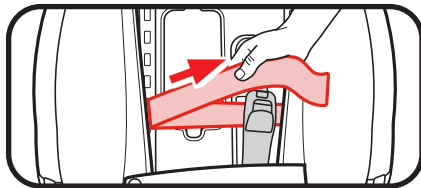

15. Close the SnugLock® Lock-Off

When the slack is removed, close the SnugLock® Lock-Off until you hear a “Click”. Make sure the Lower Anchor strap is under the SnugLock® Lock-Off.

⚠ WARNING!

Keep hands away from the lock-off area when closing the lock-off.

16. Attach Tether Strap

Extend the tether by pressing the grey button and pulling out on the strap and attach.

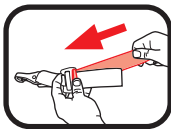

Consult vehicle's owner manual for specific location.

17. Tighten Tether Strap

Remove all the slack.

18. Test For Tightness

Grab the sides of the seat where the lower anchor strap is and slide the car seat side-to-side and front-to-back.

If the seat moves less than 1" (2.5 cm), it is tight enough.

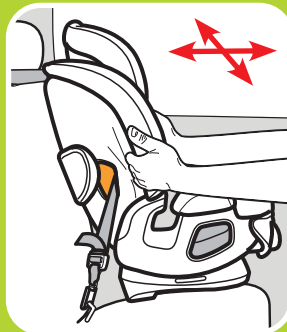
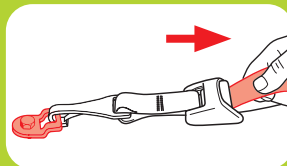
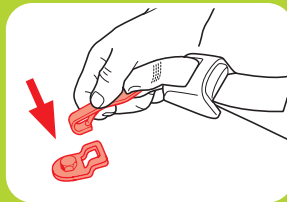

7-B Install Highback
Booster

7-B Install Highback Booster

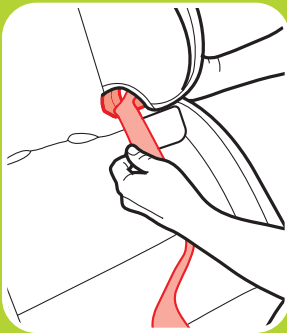
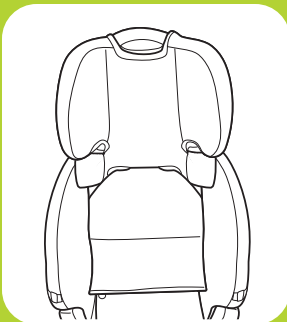

19. Replace the Seat Pad

Move the headrest back to its proper position for your child.

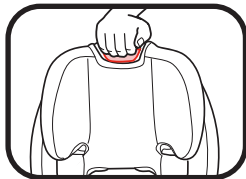

20. Thread the Vehicle Seat Shoulder Belt Through Seat Belt Guide on the Headrest

See section 7-E to secure your child.



7-C Install Backless Booster

7-C Install Backless Booster

1. Remove the Seat Back by First Loosening the Harness Straps

Removing the seat back will be easier if the harness is loose. Lift up on the harness release lever while pulling out on the harness straps.

Unbuckle buckle strap if it is buckled.

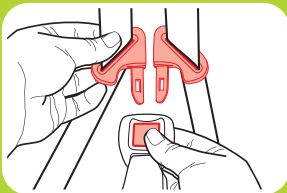
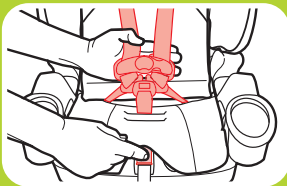

2. Remove Seat Insert

If the Seat Insert is installed, it must be removed to use the seat in Booster mode.

To remove, pull out the pins on each side.

7-C Install Backless Booster

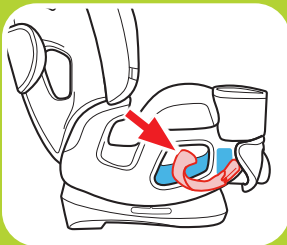
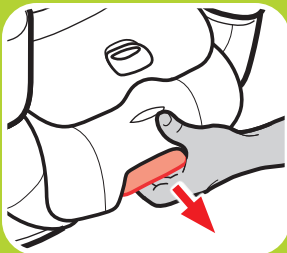
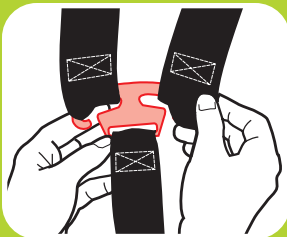

3. Remove Harness Straps from Splitter Plate

From the back of the car seat, remove harness straps from splitter plate.

4. Recline the Car Seat

Place car seat in recline position 6.

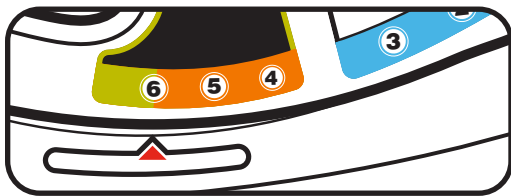

5. Make Sure the Lower Anchor Strap is in the Rear-Facing Belt Path Marked With a Blue Label

To move the lower anchor attachment, review section 6.

6. Raise the headrest to the highest position.

7. Move Cupholders Out

Make sure the cup holders are pushed outward.

8. Remove The Seat Belt Trainer

DO NOT use the Seat Belt Trainer with the seat in Backless Booster mode.

Pull the lever on the front of the Seat Belt Trainer. Then lift up the Seat Belt Trainer and remove it from the car seat.

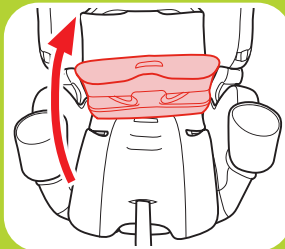
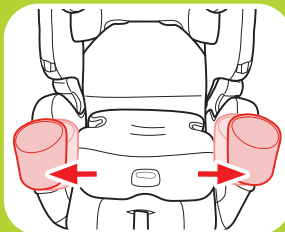
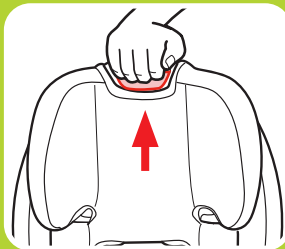
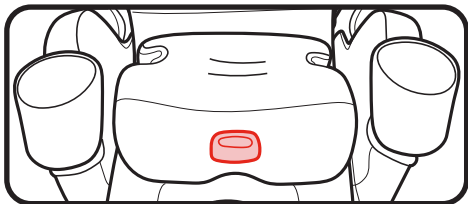

7-C Install Backless Booster

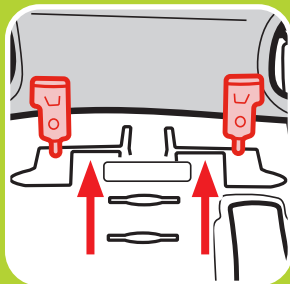
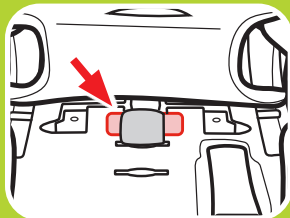
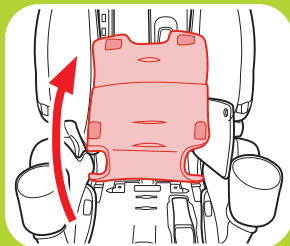

9. Lift The Seat Pad

Lift Bottom Seat Pad all the way Up To Expose the Plastic Shell.

10. Make Sure the Buckle is Stored

Make sure the buckle is stored inside the slot in the car seat shell as shown

11. Lift the Red Backrest Lock Up

With the car seat in the 6th recline position, lift the red backrest locks up and slide together.

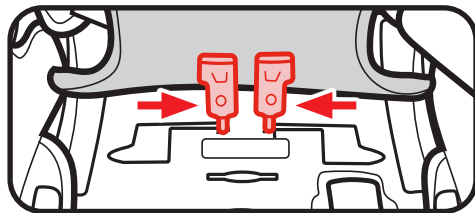

12. Remove Seat Back from Seat Base

Make sure the seat is in recline position 6. Next, tilt the seat back forward and lift out of the base.

To replace the seat back, reverse steps 1 through 11.

13. Relock the Red Backrest Locks

Make sure they are both flat and locked into place.

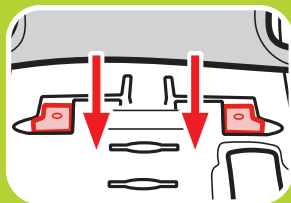
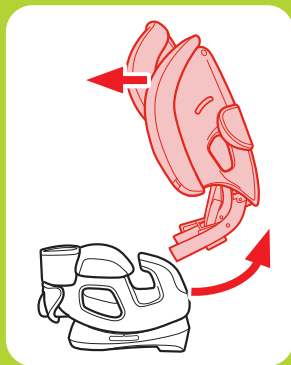

7-C Install Backless
Booster

7-C Install Backless Booster



14. Replace The Seat Pad

15. Store Splitter Plate

On the back of the seat, store the splitter plate under the tab as shown. Pull the harness adjustment strap tightly to keep the splitter plate in place.

16. Place the Booster Seat Forward-Facing in the Back Seat of Vehicle

Place forward-facing on a vehicle seat that has a lap/shoulder seat belt. Push it back firmly until the back of the car seat touches the vehicle seat back. The base should sit as flat as possible on the vehicle seat.

See section 7-F to secure your child.

**The car seat MUST stay in recline position 6.
DO NOT use any other recline position in backless booster mode.**

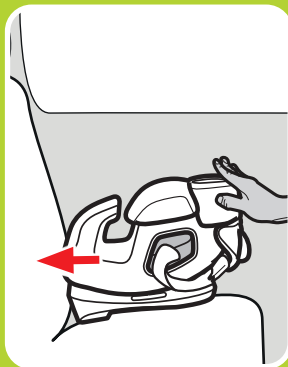

7-C Install Backless
Booster



7-D Install Seat Belt Trainer

7-D Install Seat Belt Trainer

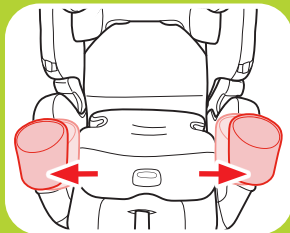

1. Move Cupholders Out

Make sure the cup holders are pushed outward.

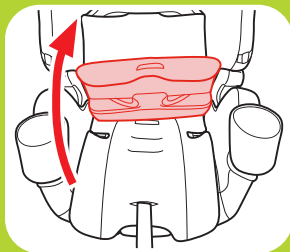

2. Remove Seat Belt Trainer

Pull the lever on the front of the Seat Belt Trainer. Then lift up the Seat Belt Trainer and remove it from the car seat.

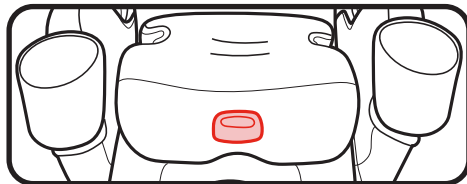

3. Rotate the Seat Belt Guides Out as Shown

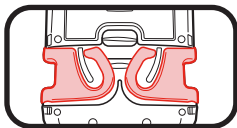

4. Open Storage Door and Pull Out the Shoulder Belt Positioning Clip

Close the storage door so it clicks closed.

Skip to step 5 if Shoulder Belt Positioning Clip is not needed to get a good fit

5. Place Seat Belt Trainer Seat Right Side Up, Forward-Facing Flat on Back Seat of Vehicle

See section 7-G to secure your child

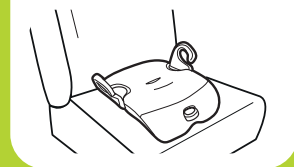
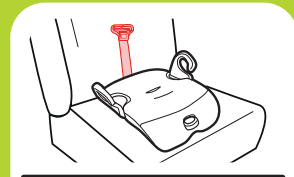
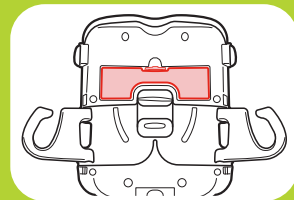

7-D Install Seat Belt Trainer



7-E Securing Child Highback Booster

7-E Securing Child Highback Booster

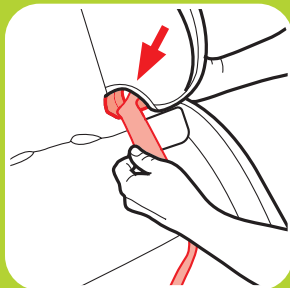

!WARNING!

Warning! Use only the vehicle lap and shoulder belt system when restraining the child in the booster seat.

1. Place Child In Seat

Have your child sit in the booster seat, with his/her back flat against the back of the booster seat.

2. Thread Vehicle's Shoulder Belt Into Seat Belt Guide in the Headrest

3. Buckle the Vehicle Lap/Shoulder Seat Belt

Be sure the lap portion of the vehicle seat belt goes behind the armrests.

Be sure the lap portion of the vehicle seat belt lies low across your child's hips.

Be sure the shoulder belt lies across your child's shoulders, between the neck and edge of shoulder. The belt guides should be even with or just above the shoulders.

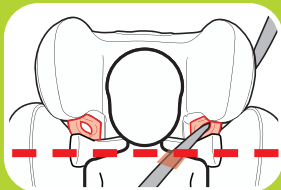
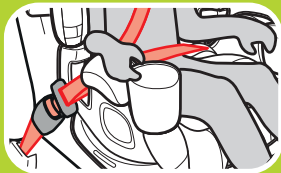

7-E Securing Child
Highback Booster



7-F Securing Child Backless Booster

7-F Securing Child Backless Booster

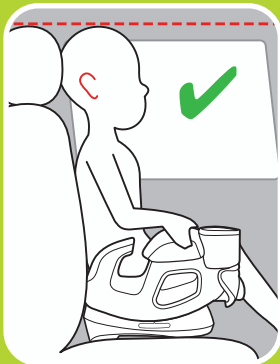

!WARNING!

Warning! Use only the vehicle lap and shoulder belt system when restraining the child in the booster seat.

1. Place Child In Seat

Make sure to push the booster back firmly until the back of the car seat touches the vehicle seat back. Have your child sit in the booster seat, with his/her back flat against the back of the vehicle seat.

2. Ears Must Be Below the Top of the Vehicle Seat Back or Headrest.

3. Buckle the Vehicle Lap/Shoulder Seat Belt

Be sure the lap portion of the vehicle seat belt goes behind the armrests.

Be sure the lap portion of the vehicle seat belt lies low across your child's hips.

Be sure the shoulder belt lies across your child's shoulders, between the neck and edge of shoulder.

You may need to use the belt positioning clip to help get a good fit.

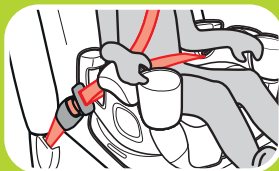
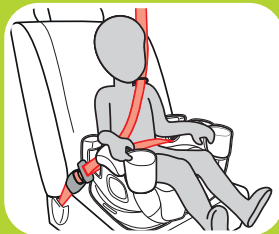

7-F Securing Child
Backless Booster



Using Belt Positioning Clip

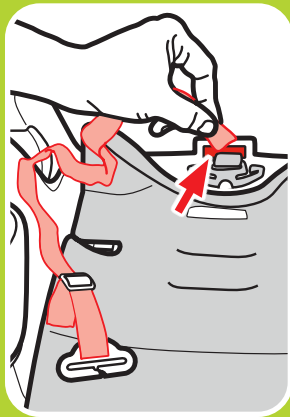

1. Make Sure Vehicle's Seat Shoulder Belt Lays in the Red Zone As Shown

If the vehicle's seat shoulder belt lays outside this zone, you **MUST** use the belt positioning clip.

Do not use the belt positioning clip if the belt is already laying inside this zone.

2. Attach Belt Positioning Clip

Insert the loop end of the strap through the same slot as the harness adjustment strap as shown.

3. Push Clip and Strap Through Loop

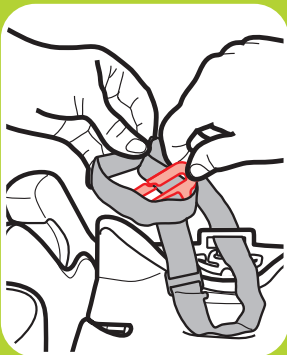

4. Pull to Tighten Strap

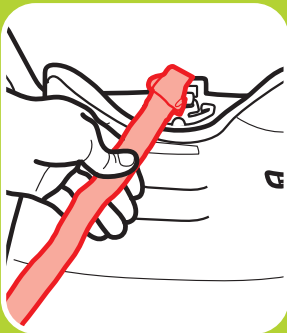

7-F Securing Child
Backless Booster

7-F Securing Child Backless Booster

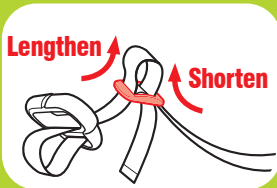
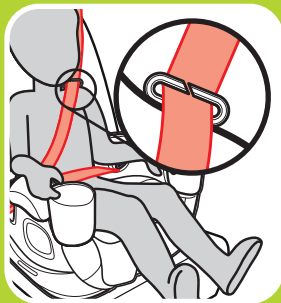

5. Place Child in Seat, Buckle Child In Seat and Attach Belt Positioning Clip

With child's back flat against the back of the vehicle seat, buckle child in. Then slide the clip onto the vehicle's seat shoulder belt as shown.

6. Adjust the Belt Positioning Clip to Fit Your Child

Lengthen or shorten the belt length as shown.

Clip should fit right at the top of shoulder as shown.

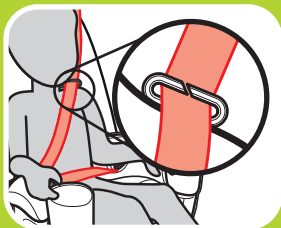

7-F Securing Child Backless Booster



7-G Securing Child Seat Belt Trainer

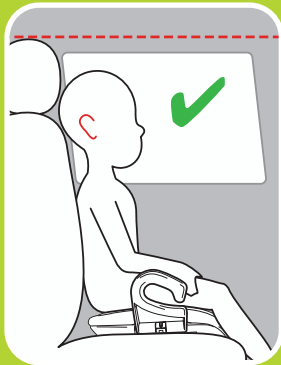

7-G Securing Child Seat Belt Trainer

! WARNING!

Warning! Use only the vehicle lap and shoulder belt system when restraining the child in the booster seat.

1. Place Child In Seat Belt Trainer

Have your child sit in the Seat Belt Trainer, with his/her back flat against the back of the vehicle seat.

2. Ears Must Be Below the Top of the Vehicle Seat Back or Headrest.

3. **Buckle the Vehicle Lap/Shoulder Seat Belt**

Be sure the lap portion of the vehicle seat belt goes through both seat belt guides and the shoulder belt goes through the seat belt guide on the buckle side.

Be sure the lap portion of the vehicle seat belt lies low across your child's hips.

Be sure the shoulder belt lies across your child's shoulders, between the neck and edge of shoulder.

You may need to use the belt positioning clip to help get a good fit.

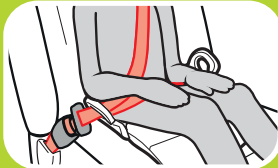
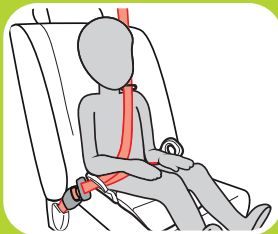

7-G Securing Child
Seat Belt Trainer

7-G Securing Child Seat Belt Trainer



Using Belt Positioning Clip

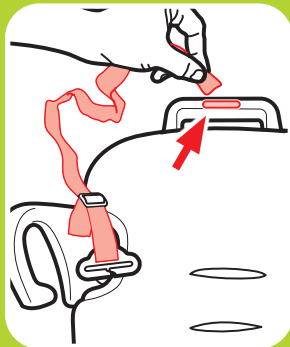
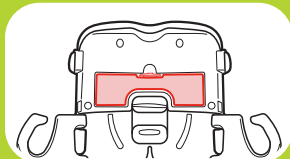

1. **Make Sure Vehicle's Seat Shoulder Belt Lays in the Red Zone As Shown**

If the vehicle's seat shoulder belt lays outside this zone, you **MUST** use the belt positioning clip.

Do not use the belt positioning clip if the belt is already laying inside this zone.

2. **Open Storage Door and Pull Out the Shoulder Belt Positioning Clip**

Close the storage door so it clicks closed.

3. **Attach Belt Positioning Clip**

Insert the loop end of the strap through the slot on the back of the Seat Belt Trainer as shown.

4. Push Clip and Strap Through Loop

5. Pull to Tighten Strap

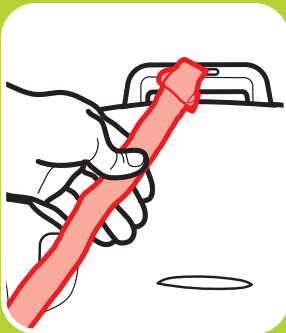
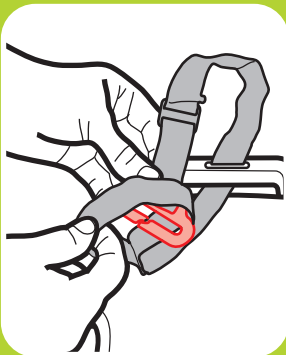

7-G Securing Child
Seat Belt Trainer

7-G Securing Child Seat Belt Trainer

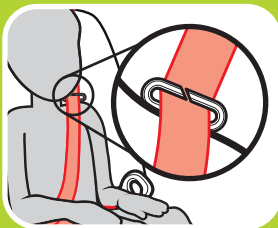
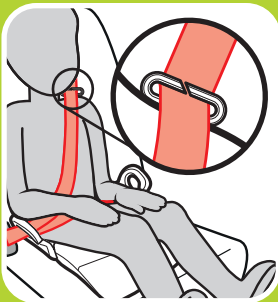

6. Place Child in Seat, Buckle Child In Seat and Attach Belt Positioning Clip

With child's back flat against the back of the vehicle seat, buckle child in. Then slide the clip onto the vehicle's seat shoulder belt as shown.

7. Adjust the Belt Positioning Clip to Fit Your Child

Lengthen or shorten the belt length as shown.

Clip should fit right at the top of shoulder as shown.

8 Installing and Removing Seat Belt Trainer From Car Seat

The Seat Belt Trainer **MUST** be installed when the seat is used in Rear-Facing mode.

DO NOT use the Seat Belt Trainer with the seat in Forward-Facing or Booster mode.

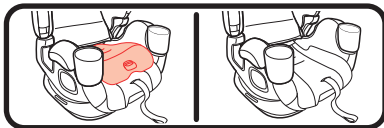

To Install the Seat Belt Trainer:

1. Store the Belt Guides

The belt guides **MUST** be folded underneath the Seat Belt Trainer as shown when the trainer is installed in the car seat.

2. Unbuckle the Buckle

Unbuckle the buckle strap if the seat is being used in harness mode.

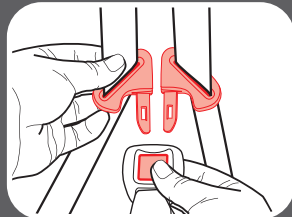
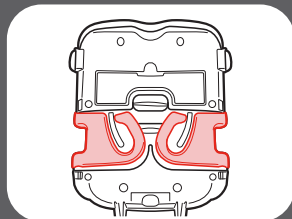

8 Installing & Removing
Seat Belt Trainer



8 Installing & Removing Seat Belt Trainer

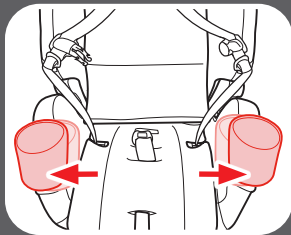
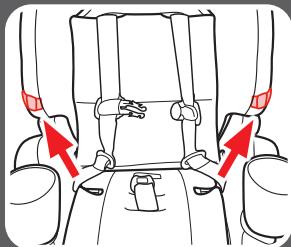

3. *Buckle Tongue Storage Pockets*

Place buckle tongues in the buckle tongue storage pockets on both sides of the seat.

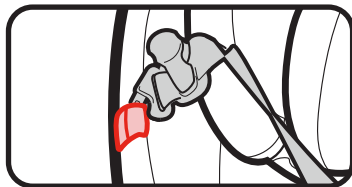

4. *Move Cupholders Out*

Make sure the cup holders are pushed outward.

5. Insert Locking Tab

Insert the locking tab on the rear of the Seat Belt Trainer into the slot near the seat crease on the car seat.

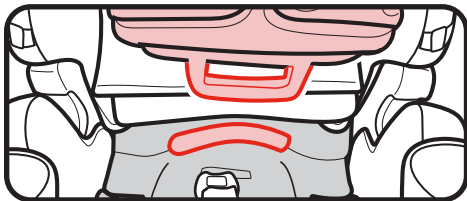

6. Thread the Buckle

Thread the buckle strap through the **MATCHING** buckle slot in the Seat Belt Trainer if the seat is being used in harness mode.

If the buckle is in the rear slot, you will need to partially open the belt guides.

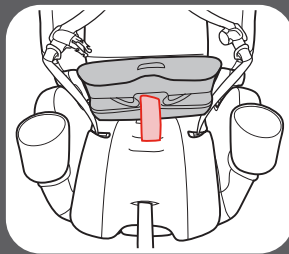
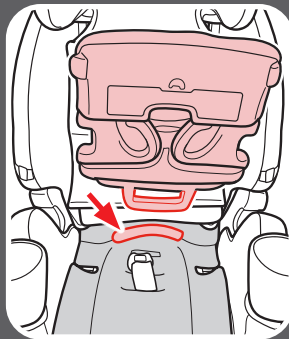
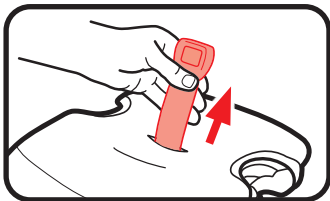

8 Installing & Removing Seat Belt Trainer



8 Installing & Removing Seat Belt Trainer

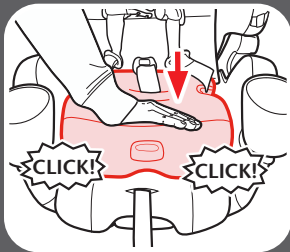
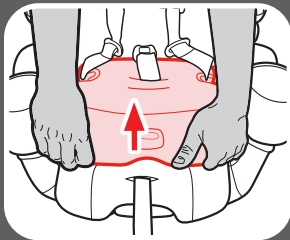

7. Attach the Seat Belt Trainer

Push the front of the Seat Belt Trainer down on the Seat Base. You will hear a click when it is securely in place.

Make sure the harness straps pass through the openings in the sides of the Seat Belt Trainer and are not caught underneath the Seat Belt Trainer. if the seat is being used in harness mode.

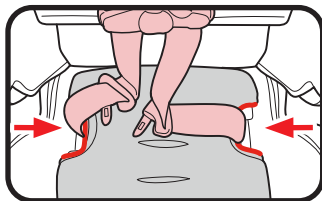

CHECK that the Seat Belt Trainer is securely attached by pulling on both sides.



To Remove the Seat Belt Trainer:

1. Unbuckle the Buckle

Unbuckle the buckle strap if the seat is being used in harness mode.

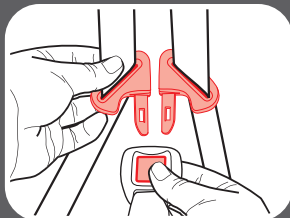

2. Move Cupholders Out

Make sure the cup holders are pushed outward.

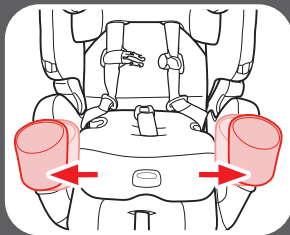

3. Remove The Seat Belt Trainer

Pull the lever on the front of the Seat Belt Trainer. Then lift up the Seat Belt Trainer and remove it from the car seat.

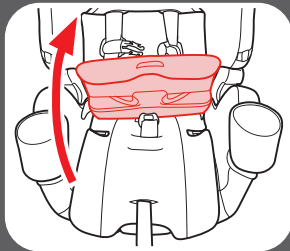
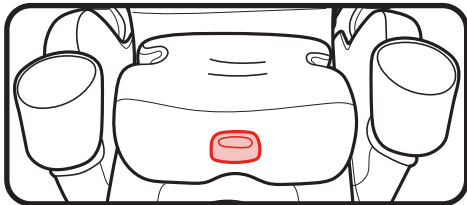

9-A Accessories *(on select models)*

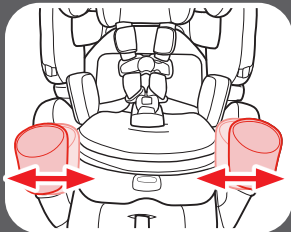

Cup Holders

The cup holders are adjustable and can be shifted left or right.

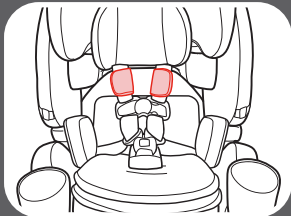

Harness Covers

Make sure that harness covers do not interfere with placement of the chest clip at armpit level.

To remove, undo the fastening strips and remove.

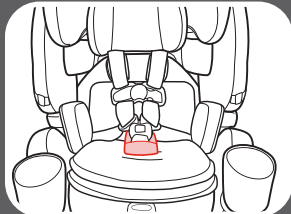

Buckle Cover

To remove, unclip the buckle and slide cover over the buckle.

The Infant Head Support and the Infant Body Support can only be used Rear-Facing for children weighing less than 20 lb (9 kg). Use the infant support pieces to ensure the child is secure, comfortable, and their head does not tilt forward. Use the following guidelines:

Infant Head Support

Never allow the head support to bunch or fold behind child.

To install, insert the tabs on the back of the infant head support into the slots on the headrest.

To remove, pull the infant head support away from the headrest.

Infant Body Support

Infant Body support must be used if shoulders are below the lowest harness setting.

Never allow infant body support to bunch or fold behind child.

To remove, unbuckle the buckle and pull out the infant body support.

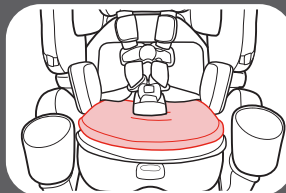
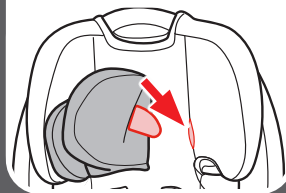
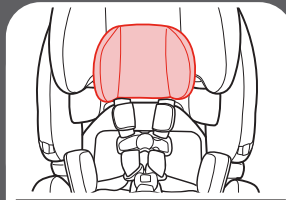

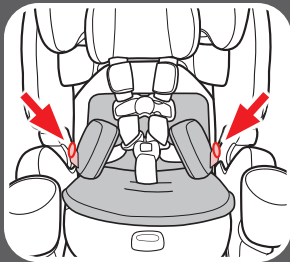
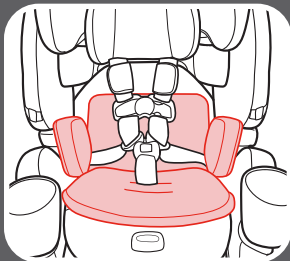

Seat Insert

The seat insert *MUST* be used for children 40 lb (18 kg) or less.

The seat insert *MUST* be removed for children over 40 lb (18 kg).

Never allow seat insert to bunch or fold behind child.

To install, unbuckle the harness and attach the pins on each side of the seat insert into the holes near the seat crease just behind the booster belt guide.

Then, route the buckle through the same slot in the seat insert.

Make sure harness straps are routed through the seat insert and are not twisted.

To remove, unbuckle the harness and pull out the pins on each side.

10-A How to Uninstall Lower Anchor Connectors and Tether

Lower Anchor Connectors

To remove the lower anchor connectors from the lower anchors, push in on the red buttons and pull them off.

Tether

To remove, press the grey button and pull out on the strap to release the tension. Press in on the hook's spring. Push tether hook in, then lift up and pull away from tether anchor.

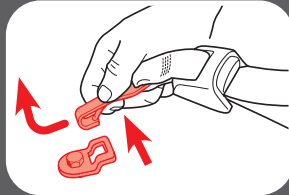
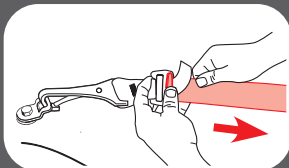
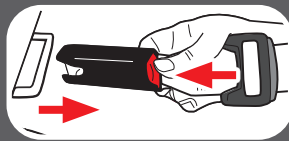



10-B Choosing Vehicle Seat Location

Review your vehicle owner's manual for Seating Locations

The best seating location for this car seat is one that:

- Is recommended by your vehicle owner's manual, and
- Results in a secure installation of this car seat

In the event there is no available back seat and / or you have no other option than to place a child other than an infant in a rear-facing car seat in a front passenger seating position, the National Highway Traffic Safety Administration (NHTSA) recommends that you take the following steps:

- Ensure the child is properly restrained according to their age and size
- Move the seat as far back as possible
- Make sure the child is not leaning out of position, such as leaning forward into the deployment path of the air bag
- Set the air bag ON-OFF switch, if available, to the OFF position

10-C Which Installation Method Should I Use?

This car seat can be installed in your vehicle using either the vehicle seat belt **OR** the lower anchor attachment. Both are equally safe to use. **INSTALL USING ONLY ONE METHOD.**

Graco allows the securing of the car seat with the LATCH system in the booster mode, only if the vehicle manufacturer allows it. The child still **MUST BE SECURED** with the vehicle lap/shoulder seat belt.

Vehicle Seat Belt: Review section 10 and your vehicle owner's manual to learn how to install your car seat with the vehicle seat belts.

LATCH or Lower Anchor Attachment: The LATCH system or lower anchor attachment allows you to securely attach your safety seat in your car without using the vehicle seat belt and possibly to get a better fit. All 2003 and newer model year vehicles are required to have a LATCH system, although some manufacturers began including LATCH earlier. Some vehicle owner manuals use the term ISOFIX to identify the LATCH system.

Review your vehicle owner's manual for exact location and use.

Vehicle's Tether Anchor

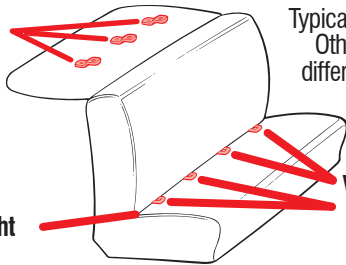

Vehicle Seat Belt

Typical seat in a passenger vehicle. Other vehicle types may have different lower anchor and tether anchor locations.

Vehicle's Lower Anchor





10-D Unsafe Vehicle Seat Locations

Never install this car seat in any of the following vehicle seating locations:



rear-facing or side-facing vehicle seats



rear-facing with an active front air bag



booster mode with vehicle lap belt only seat belt

10-E Vehicle Seat Belts

Review your vehicle owner's manual for vehicle seat belt use

This car seat can be installed using a vehicle seat belt. To do this, you will need to change the seat belt to a locked mode for use with car seats. With some vehicle seat belts, this is done with the latchplate; with other vehicle seat belts, this is done with the retractor.

Vehicle Seat Belt Terms

Retractor

A device that winds up the unused vehicle seat belt. It is often hidden inside the panels on the walls of the vehicle or in the vehicle seatback.

Latch Plate

The male end of the seat belt with the silver tongue.

Seat Bight

The crease where the vehicle seat back and seat bottom meet.

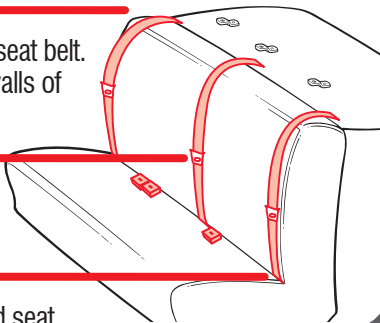



Identify Your Seat Belt Type

There are two different types of vehicle seat belts that can be used with this car seat:

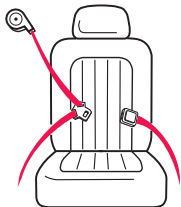

Lap/Shoulder Belt

3 connections points. Can be used in all car seats modes of use.

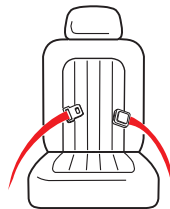

Lap Belt Only

2 connection points. **Can ONLY be used in harness mode.**

The following types of vehicle seat belts **CANNOT** be used safely with this car seat:



Lap Belt with Motorized Shoulder Belt



Lap Belt or Shoulder Belt Mounted on Door

Belts Forward of the Seat Bight

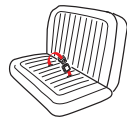

Some vehicles you may not get a secure fit. Read both your vehicle and car seat manuals.

Lap/Shoulder Seat Belt Installation - Harness Mode



10
Additional
Information

Always review your vehicle owner's manual for specific information about your vehicle seat belts.

Most vehicles manufactured after 1996 will have Switchable retractors in the back seat. If you have any questions about your retractor type, consult your vehicle owner's manual, call Graco or visit www.gracobaby.com/vehicle-seatbelt-information.

To verify you have a Switchable retractor, **slowly** pull the belt all the way out, and then allow it to retract several inches. Try to pull the belt all the way out again. If it cannot be pulled out, it is **Switchable** retractor. Follow the steps in the rear-facing/forward-facing sections in this manual.

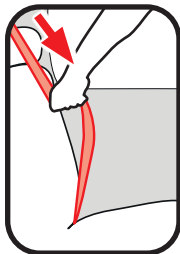



10 Additional Information

10-F Aircraft Installation

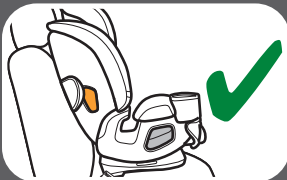
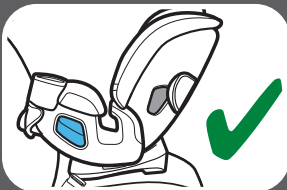

This child restraint is certified for use in aircraft when using the harness system, and **ONLY** when not using the SnugLock® lock-off.

This child restraint is not certified for aircraft use when used as a booster seat because aircrafts do not have shoulder belts. When in booster mode, **NEVER** use a lap-only belt across front of child.



1. Move the Lower Anchor Attachment

Rear-Facing: If installing rear-facing, move the lower anchor attachment to the forward-facing belt path marked with an orange label.

Forward-Facing: If installing forward-facing, move the lower anchor attachment to the rear-facing belt path marked with a blue label.

See section 6 to move Lower Anchor attachment.

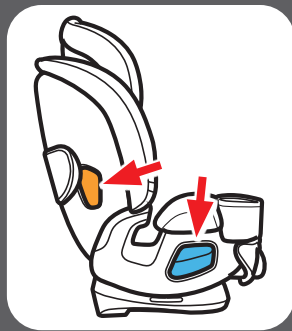

2. Route the Aircraft Seat Belt Over the SnugLock® Lock-off

Thread the aircraft seat belt through the belt path and out the other side. Buckle it. The seat belt should lie as flat as possible and not be twisted.

Note: It may be easier to route the aircraft seat belt by lifting seat pad up to expose the belt path.

Rear-Facing: Make sure the aircraft seat belt is **(A)** in front of the buckle strap when the buckle is in the inner-most position, and **(B)** in behind when in the outer-most position and that it is flat and is not twisted.

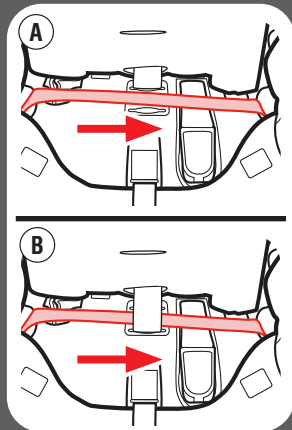

10 Additional Information

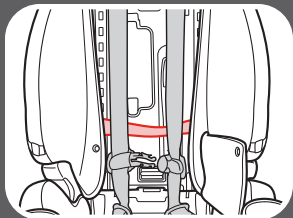

Forward-Facing: Make sure the aircraft seat belt is routed behind the harness strap, is flat, and is not twisted.

For complete rear-facing installation, see section 3-C, and for forward-facing installation, see section 4-C but do not use the tether.

11-A Cleaning Seat Insert

Refer to care tag for washing instructions.

Seat Insert

Clean with a damp sponge using mild soap and cool water.

To remove pad, on each side, remove the pin from the seat on each side of the support.

You must remove the plastic blocks from the side panels. To remove, open the pockets and remove the plastic block pieces.

Reverse the steps to insert the plastic block pieces and re-attach seat insert.

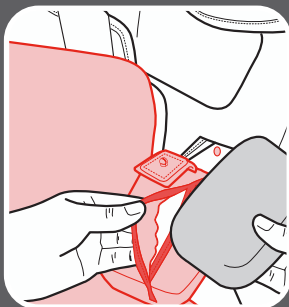
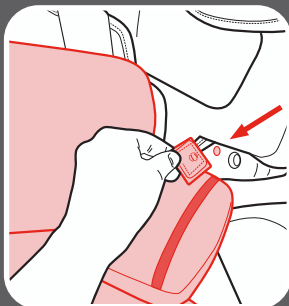

11
Care &
Cleaning



11-B Cleaning Seat Pads

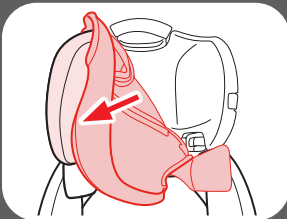
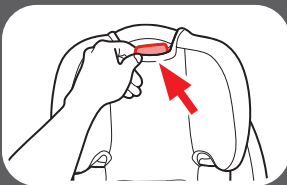

Refer to seat pad care tag for washing instructions.

Headrest Pad

Clean with a damp sponge using mild soap and cool water. If needed, pad may be removed for cleaning.

To remove, raise the headrest to the highest position. Pull plastic tab out from below the headrest height adjustment lever.

Remove the upper part of the headrest pad from around the headrest.

Carefully slide the pad off the headrest-bumpers.

Machine wash pad in cold water on delicate cycle and drip-dry. **DO NOT USE BLEACH.**

Reverse the steps to reattach the pad on the headrest.

Seat Pad

Clean with a damp sponge using mild soap and cool water. If needed, cover may be removed for cleaning.

To remove, pull out the two clips near the seat crease.

Lift the seat pad all the way up to undo the four fastening strips.

Machine wash pad in cold water on delicate cycle and drip-dry. **DO NOT USE BLEACH.**

Reverse the steps to reattach the pad to the shell.

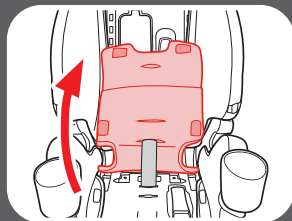
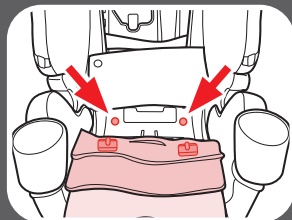
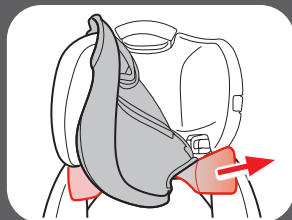

11
**Care &
Cleaning**

11 Care & Cleaning

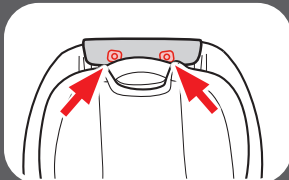
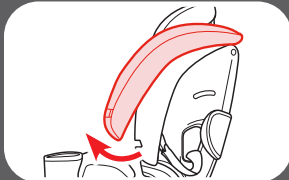
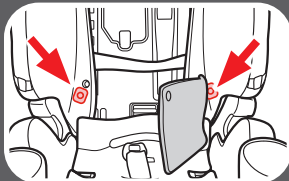
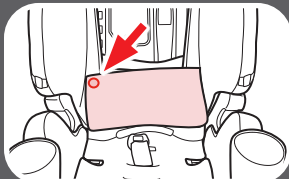

Side Pad

Clean with a damp sponge using mild soap and cool water. If needed, pad may be removed for cleaning.

To remove, undo the snap on the top corner of the seat pad back.

On some models: Pull out the clip on each side near the forward-facing belt path.

Then pull the side pads from the shell.

Machine wash pad in cold water on delicate cycle and drip-dry. **DO NOT USE BLEACH.**

Reverse the steps to reattach the pad to the shell.

Top Pad

Lower the headrest to the lowest position, and pull out the two clips at the top of the car seat shell.

From the back of the car seat, pull out the plastic tab at the top of the car seat shell.

Machine wash pad in cold water on delicate cycle and drip-dry. **DO NOT USE BLEACH.**

Reverse the steps to reattach the pad to the shell.

Front Seat Pad

Clean with a damp sponge using mild soap and cool water. If needed, pad may be removed for cleaning.

To remove, pull out the four clips along the seat bottom as shown.

Pull out the two plastic tabs on either side of the recline handle.

Pull out the plastic tab from below each armrest, and pull out the plastic tabs below each cup holder.

Remove the front seat pad.

Machine wash pad in cold water on delicate cycle and drip-dry. **DO NOT USE BLEACH.**

Reverse the steps to reattach the pad to the shell.

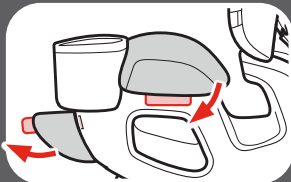
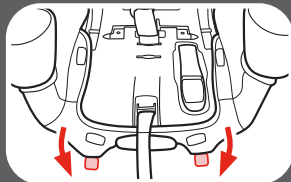
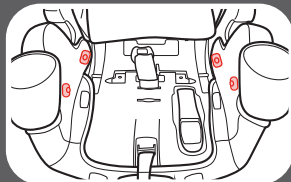
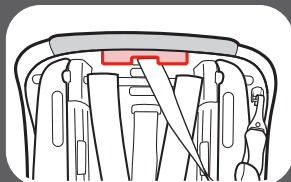

11 Care &
Cleaning

11 Care & Cleaning

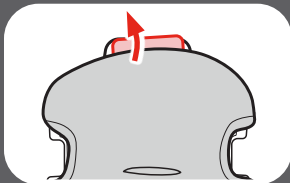
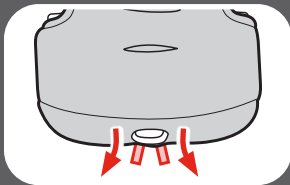
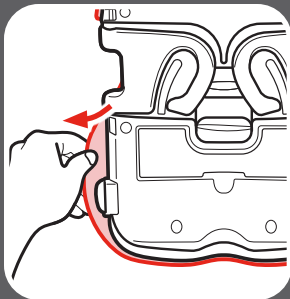

Seat Belt Trainer

Clean with a damp sponge using mild soap and cool water. If needed, the Seat Belt Trainer pad may be removed for cleaning.

To remove the seat pad, start from the sides of the Seat Belt Trainer and pull the pad out from around the plastic shell.

Pull the two small plastic tabs out from underneath the release lever.

Then pull the plastic tab out from the rear of the shell.

Machine wash pad in cold water on delicate cycle and drip-dry. **DO NOT USE BLEACH.**

11-C Cleaning the Buckle

To clean the buckle, review section 5 for removing and reinstalling the buckle.

With the buckle removed, place in a cup of warm water and gently agitate the buckle. Press the red button several times while in the water.

DO NOT SUBMERGE THE BUCKLE STRAP. DO NOT USE SOAPS, HOUSEHOLD DETERGENTS or LUBRICANTS.

Shake out excess water and allow to air dry. Repeat steps as needed until it fastens with a click. Re-insert the buckle into the same slot it was removed. Pull up on buckle strap to make sure it is secured.

WARNING! Inspect and clean buckle from time to time to remove any objects or debris that could prevent latching.

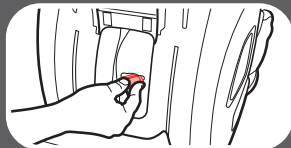
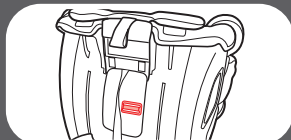

11 Care & Cleaning

11-D Cleaning Harness, Lower Anchor Attachment and Tether

Surface wash only with mild soap and damp cloth. **DO NOT IMMERSE THE HARNESS STRAPS, LOWER ANCHOR STRAP, or TETHER STRAP IN WATER.**

Doing so may weaken the straps.

If harness straps, lower anchor strap or tether strap are frayed or heavily soiled, contact Customer Service at www.gracobaby.com or 1-800-345-4109.

Replacement Parts

To purchase parts or accessories in the United States,
please contact us at the following:

www.gracobaby.com

or

1-800-345-4109



Store instruction manual in the
slot with the instruction book
icon as shown.

