

THE NAVIGATOR



Bali™

FROZEN CONCOCTION MAKER®

The Best Margaritas Come From Margaritaville®



Model DM3500 Series User Manual

IMPORTANT SAFEGUARDS

WHEN USING ELECTRICAL APPLIANCES, BASIC SAFETY PRECAUTIONS SHOULD ALWAYS BE FOLLOWED, INCLUDING THE FOLLOWING:

1. **READ ALL INSTRUCTIONS BEFORE USING.**
2. To protect against electric shock, do not immerse appliance, cord or plug in water or other liquids.
3. Close supervision is necessary when any appliance is used near children. This appliance should not be used by children.
4. Switch unit to OFF and unplug from outlet when not in use, before putting on or taking off parts, and before cleaning.
5. Flashing light indicates ready to operate. Avoid any contact with blades or moveable parts.
6. Do not operate any appliance with damaged cord or plug or after the appliance malfunctions, or is dropped or damaged in any manner. Contact 1-877-689-2737 for customer service.
7. Do not use outdoors.
8. Do not let cord hang over the edge of a table or counter, or touch hot surfaces, including the stove.
9. Keep hands and utensils out of container while blending and/or ice shaving to reduce risk of severe injury to persons or damage to the unit. A rubber spatula may be used but must be used only when the appliance is not running.
10. Blades are sharp; handle carefully.
11. Always operate appliance with Chamber Lid and Ice Reservoir Lid in place.
12. The use of attachments not recommended or sold by the manufacturer may cause fire, electric shock or injury.
13. Do not use broken, chipped, or cracked Chamber or Ice Reservoir.
14. To reduce risk of injury to persons, never place blending blade assembly on base without the Chamber properly attached.
15. Do not leave appliance unattended while it is operating.

16. To disconnect, turn control to off, then remove plug from wall outlet.
17. Do not use appliance for other than intended use.
18. Never place fingers or other utensils into feed or discharge areas.
19. Check Ice Reservoir for presence of foreign objects before using.
20. Be certain the Chamber Lid and Ice Reservoir Lid are securely locked in place before operating appliance.
21. Do not blend hot liquids.

NOTE: NEVER SHAKE OR REMOVE CHAMBER DURING OPERATION AS JAR BLADE ASSEMBLY CAN GET DAMAGED.

SAVE THESE INSTRUCTIONS FOR HOUSEHOLD USE ONLY

Polarized Plug

This appliance has a polarized plug (one blade is wider than the other). As a safety feature, this plug will fit in a polarized outlet only one way. If the plug does not fit fully into the outlet, reverse the plug. If it still does not fit, contact a qualified electrician. Do not attempt to defeat this safety feature.

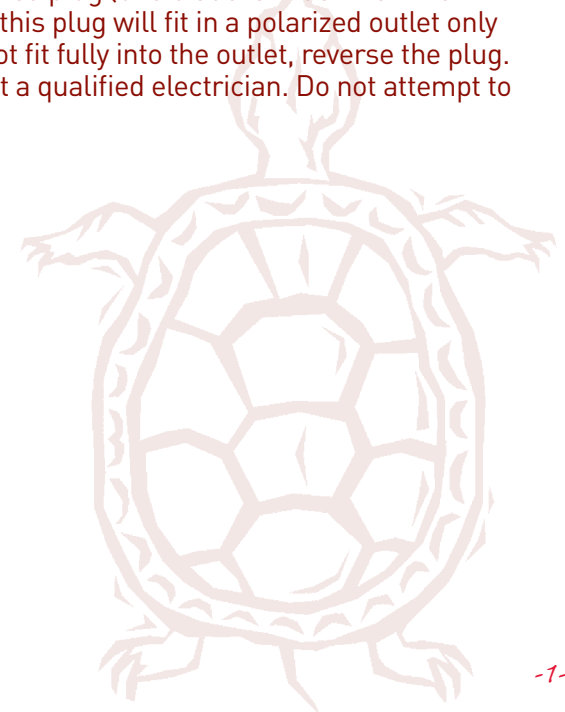

WELCOME

*Congratulations on your purchase of the Margaritaville®
Frozen Concoction Maker® – DM3500 Series!*

To learn more about Margaritaville® products,
please visit us at www.margaritavillecargoo.com.

FROZEN CONCOCTION MAKER®

PARTS LIST

- 1 **Ice Reservoir Lid** – Covers the Ice Reservoir.
- 2 **Ice Reservoir** – Holds the ice for making frozen drinks.
- 3 **Shaving Paddle** – Moves ice across the Shaving Blade.
- 4 **Ice Deflector Blade Assembly**
Includes:
 - 4a **Ice Hopper**
 - 4b **Ice Deflector**
 - 4c **Shaving Blade Assembly Ring**
 - 4d **Blade**
- 5 **Ice Chute** – Directs ice from Ice Hopper into Chamber.
- 6 **Base** – Holds Chamber securely in place.
- 7 **Control Panel** – Contains all necessary controls to operate your unit.
- 8 **On/Off Switch** – On the back side of the machine.

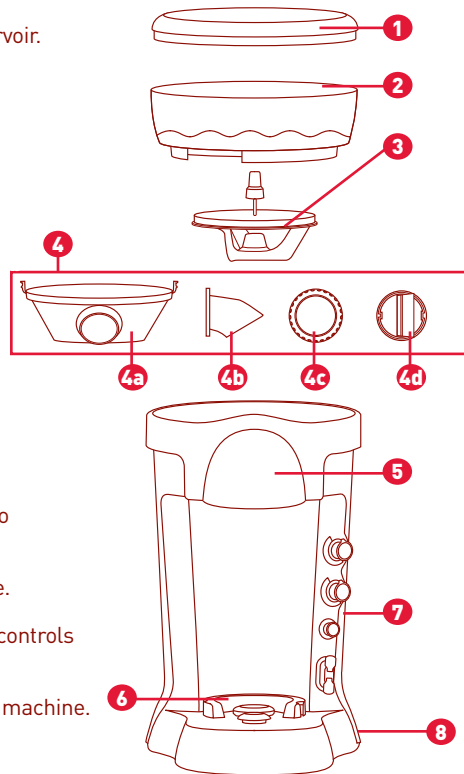

- 9 **Chamber Lid** – Seals the Chamber.
- 10 **Chamber** – Maximum capacity of 60 oz.
- 11 **Blending Blade Sealing Ring** – Seals the blending jar and blending base.
- 12 **Blending Blade** – Creates forward action when blending drinks.
- 13 **Drink Dispenser with Spout and Lever**

Remix Channel Includes:

- 14 **Auger Drink Blade**
 - 15 **Auger Blade Sealing Ring**
- 16 **Ice Melt Reservoir** – Captures melted ice excess.
 - 17 **Cord Storage Door** – Covers power cord storage area.

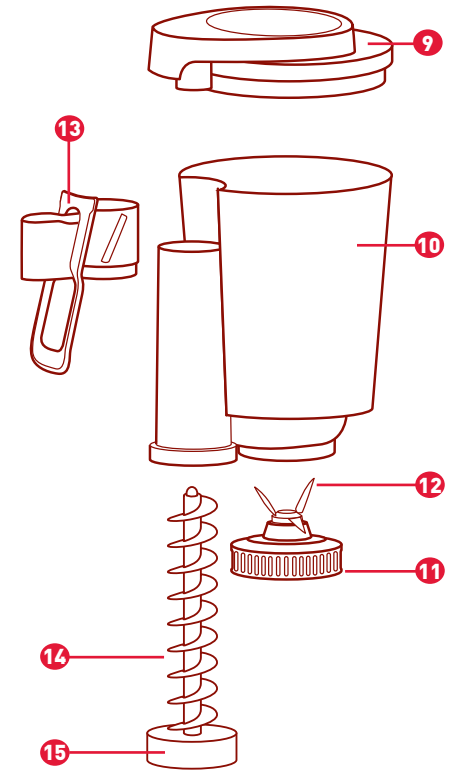

Back of Unit

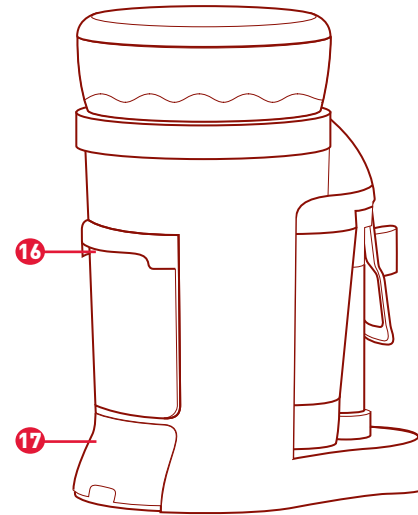

BALI™ CONTROL PANEL

MAKING FROZEN DRINKS

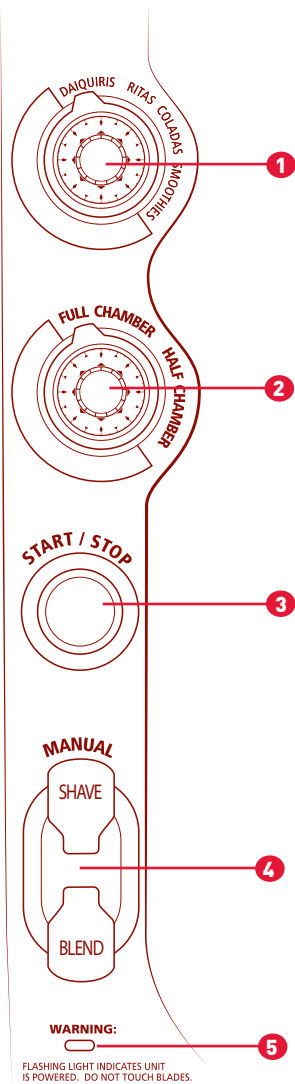

- 1 Drink Selector Dial –**
Selects from 4 different types of drinks.
 - Ritas – liquid ingredients only
 - Daiquiris – liquid ingredients + frozen fruit
 - Coladas – liquid ingredients
 - Smoothies – liquid ingredients + fresh fruit
- 2 Drink Level Dial –**
Used to select half or full chamber
 - Half Chamber = 30 oz of Frozen Drinks
 - Full Chamber = 60 oz of Frozen Drinks
- 3 Start/Stop Button –**
Used to start automatic Shave 'n Blend™ cycle. Green = Ready to Go!
- 4 Blend Only/Shave Only Switch –**
Used to manually operate ice shaver and blender.
- 5 Power Light –**
Blinks when unit is plugged in to indicate power. Avoid any contact with blades or moveable parts.

1. Place the unit on a clean dry flat surface.
2. Place the Ice Reservoir on the unit. Twist clockwise to lock into place. *Figure 1*
 - a. Add Lid, twist clockwise.

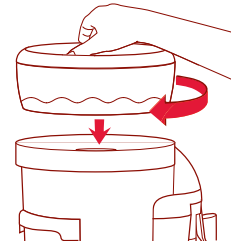

Figure 1

NOTE: IF ICE RESERVOIR IS NOT SEATED FIRMLY IN PLACE THE UNIT WILL NOT OPERATE.

3. Plug appliance in. Remove the Cord Storage Door by pushing down on the release tab located on the Cord Storage Door. Remove the power cord and plug the unit into a standard 120 Volt wall socket. Replace the Cord Storage Door and position the power cord in the slot below the cord storage release tab. *Figure 2*
4. Fill the Ice Reservoir with ice cubes. *Figure 3*

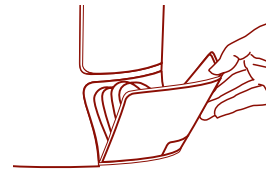

Figure 2

NOTE: NEVER PUT ANYTHING BUT ICE IN THE ICE RESERVOIR.

5. Replace the Ice Reservoir Lid and snap closed.
6. Move Ice Chute to the side. *Figure 4*
6. Lift and remove the Chamber. (The Ice Chute slides and can be moved to the side.)
7. Add appropriate amount of ingredients to the Chamber for the amount of drinks desired.

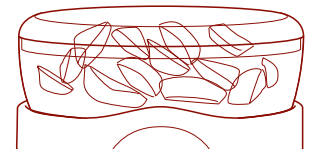

Figure 3

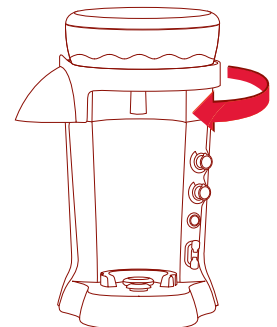

Figure 4

The Best Margarita Recipe

Ingredients	Full Chamber		Half Chamber	
	fl oz	ml	fl oz	ml
Margaritaville® Gold Tequila	8	237	4	119
Triple Sec	4	118	2	59
Lime Juice	2	60	1	30
Orange Juice	2	60	1	30
Margaritaville® Margarita Mix	6	178	3	89

The Best Daiquiri Recipe

Ingredients	Full Chamber		Half Chamber	
	fl oz	ml	fl oz	ml
Light Rum	10	295	5	148
Daiquiri Mix	9	266	4	133
Sour Mix	5	148	3	74
Frozen Strawberries	3 1/2 C	710	1 3/4 C	355

The Best Pina Colada Recipe

Ingredients	Full Chamber		Half Chamber	
	fl oz	ml	fl oz	ml
Rum	5 1/2	163	4	89
Cream of Coconut	7	208	3 1/2	104
Pineapple Juice	7	208	3 1/2	104

The Best Smoothie Recipe

Ingredients	Full Chamber		Half Chamber	
	fl oz	ml	fl oz	ml
Raspberry Sherbert	12	355	6	177
Pineapple Juice	16	473	8	236
Fresh Strawberries	2 3/4 C	651	1 1/2 C	325

For more recipes visit MargaritavilleCargo.com

C=cups

- Return Chamber to Base. Slide Ice Chute back to center.

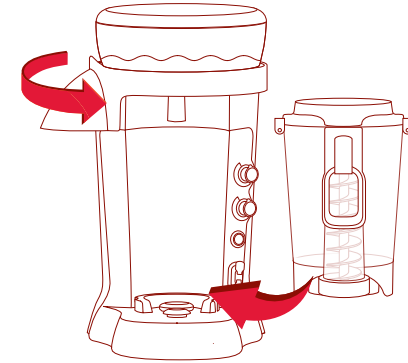

- Turn the ON/OFF Switch to the ON position. (located at the right side of unit)
- Select the type of drink to be made by turning the Drink Selector Dial to the desired setting.
- Set the Drink Level Dial to correspond to the amount of drinks being made.

NOTE: NEVER SHAKE OR REMOVE CHAMBER DURING OPERATION – BLADE ASSEMBLY WILL GET DAMAGED.

AUTOMATED SHAVE 'N BLEND™ CYCLE

- Start the automatic Shave 'n Blend™ Cycle by pressing the Start/Stop Button. Green = Ready to Go! If Start/Stop Button is blinking Red, check that all moveable parts are locked in place.
- What Will Happen:* The unit will shave ice for the appropriate time, then the blender will start automatically. The unit will stop at the completion of the cycle.
- If the frozen drink is too thin or thick, use the Blend Only/Shave Only Switch. See page 8 for manual cycle tips.

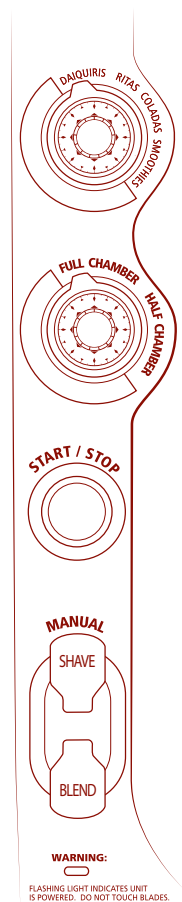

17. To Serve:

- Press glass/cup against lever.
- Pour and enjoy.

What Will Happen:

Frozen drink will blend quickly then travel up the Remix Channel and pour out. Once you release from lever, machine will re-blend frozen drink back into the Chamber.

- Periodically check the Ice Melt Reservoir and empty as needed.

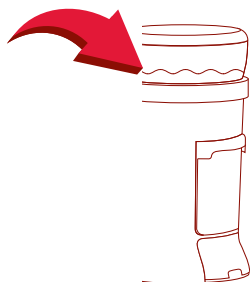
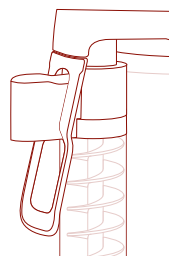

MANUAL CYCLE

To make a thicker drink:

- Hold the Shave Only Switch to add more ice to the Chamber.
- To stop adding ice, release the switch.
- To mix the newly added ice into the drink, hold the Blend Only Switch until the desired consistency is achieved. To stop the blending release the switch.
- Use less drink mixer than in recipe. (example: for 3 drinks, use 9 oz. liquid content)

To make a thinner drink:

- Hold the Blend Only Switch until the desired consistency is achieved.
- To stop blending release the switch.
- Add more drink mixer than in recipe (example: for 3 drinks, use 10.5 oz. of total mix)

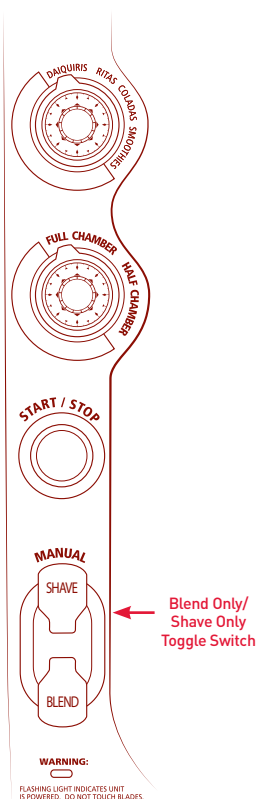

CLEANING AND MAINTENANCE

IMPORTANT: Your Chamber, Shaving and Blending Blades are subject to wear during normal use. Always inspect for nicks, chips, or cracks. Always inspect for broken, cracked, or loose blades.

If the jar or Shaving and Blending Blades are damaged, do not use. Call our toll-free customer service number, 1-877-689-2737, to obtain replacement parts.

HELPFUL TIPS:

- To remove ice from the Ice Reservoir hold the Shave Only Switch in the Shave Only position until the Ice Reservoir is empty.
- To clean Chamber, Remix Channel and Drink Dispensing Area, add warm soapy water to Chamber (approx. 30 oz) and press Blend Only Switch for 20 seconds. Dispense out through Drink Dispensing Area.

- Make sure unit is switched OFF and unplugged. Place on a clean dry surface. Twist off lid and Ice Reservoir. This will expose the Shaving Paddle and Ice Hopper. *Figure 1 & 2*

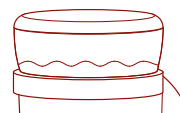

Figure 1

SHAVING BLADE

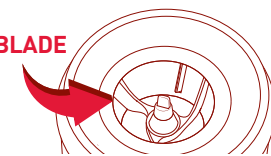

Figure 2

WARNING: DO NOT PLACE FINGERS INSIDE THE ICE HOPPER NEAR THE SHAVING BLADE. BLADE IS SHARP HANDLE CAREFULLY.

- To Remove the Shaving Paddle: Turn shaving paddle locking knob counter-clockwise until shaving paddle releases. *Figure 3*

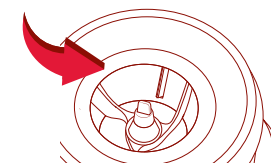

Figure 3

- Press the two Ice Hopper release tabs and lift to remove. *Figure 4*

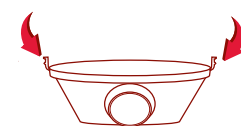
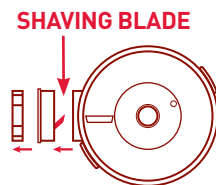

Figure 4

4. To remove the Ice Deflector Blade Assembly:

- a. Turn the **Shaving Blade Assembly Ring** counterclockwise until removed.
- b. Pull off **Ice Deflector**
- c. Remove **Blade**



RINSE ALL COMPONENTS WITH WARM SOAPY WATER AND DRY BEFORE RE-ASSEMBLING.

CLEANING THE CHAMBER

1. To Remove Lid:

Flip latches down on both sides. Remove **Lid**. (**Drink Dispenser** and **Remix Chamber** remain attached.)

2. Wash with warm, soapy water, or place on top track of the dishwasher.

RECOMMENDATION: RINSE WARM WATER THROUGH NOZZLE INSIDE DRINK DISPENSER.

3. To Clean Chamber and Remix Channel:

- a. Remove **Drink Dispenser** by pressing upwards on slanted side wings. It is a tension fit and will pop up with upward movement.
 - b. Turn **Chamber** upside-down, unscrew collar by turning counterclockwise.
 - c. **Remix Channel Blade** stays attached to collar. The whole thing can be pulled out as a unit. Do not try and detach two separate parts.
4. Unscrew large collar from **Chamber** by turning counterclockwise. Remove **Collar, Blending Blade** and **Blending Sealing Ring**.

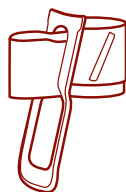

Drink Dispenser

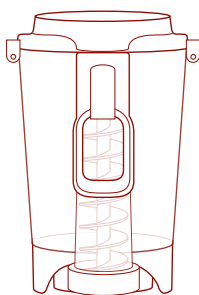

Chamber with Remix Channel

NOTE: BLADES ARE SHARP. HANDLE WITH CARE!

TROUBLESHOOTING

If the Power Indicator Light does not light:

Check that the unit is plugged into a working power outlet.

If liquid leaks from the base of the Chamber:

Remove it from the unit and check that the **Blending Blade Sealing Ring** is properly installed and that the **Chamber** is tightened.

If water leaks from the unit:

Empty the **Ice Melt Reservoir** and make sure reservoir is in place.

If the Chamber overflows during the Shave 'n Blend™ cycle:

Follow the drink recipes included in "Making Frozen Drinks" section and make sure to not exceed the specified total volume.

If the Chamber will not sit on the Blending Base:

Remove it from the unit and check for ice on the **Base**.

WARNING: unplug the unit before removing ice from the Blending Base.

If the shaver does not shave sufficient ice for the liquid in the Blending Jar:

Check that the **Number of Drinks Rotary Switch** setting corresponds to the amount of liquid in the **Chamber**.

If the drink is too watery: Make sure to follow the **Recipe Guide** (pg.6) or manually shave more ice until the desired consistency is achieved.

DOS AND DON'TS

DO NOT place fingers into the **Chamber**, **Remix Channel** or **Ice Hopper**. The blades in this unit are sharp and could cause injury.

DO NOT place **Chamber** onto **Blending Base** while motor is running. The spinning **Blending Base** could damage the **Chamber**.

DO NOT twist **Chamber** when removing. Simply lift and remove. Twisting the **Blending Jar** could loosen the **Blending Jar Base** causing it to leak.

DO NOT put hot liquid into the **Chamber**. Hot liquids could be ejected during the blending process causing injury.

DO NOT place ice, frozen foods or very cold liquids into a **Chamber** which has come directly from a hot dishwasher. The sudden change in temperature could cause the **Chamber** to crack.

DO NOT place very hot liquids or foods into a **Chamber** that has come directly from the freezer. The sudden change in temperature could cause the **Chamber** to crack.

DO follow the **Cleaning and Maintenance** instructions prior to your first use.

DO unplug the unit when not in use.

1 Year Limited Warranty

Sunbeam Products, Inc, d/b/a Jarden Consumer Solutions or if in Canada, Sunbeam Corporation (Canada) Limited d/b/a Jarden Consumer Solutions (collectively “Sunbeam”) warrants that for a period of one year from the date of purchase, this product will be free from defects in material and workmanship. Sunbeam, at its option, will repair or replace this product or any component of the product found to be defective during the warranty period. Replacement will be made with a new or remanufactured product or component. If the product is no longer available, replacement may be made with a similar product of equal or greater value. This is your exclusive warranty.

This warranty is valid for the original retail purchaser from the date of initial retail purchase and is not transferable. Keep the original sales receipt. Proof of purchase is required to obtain warranty performance. Sunbeam dealers, service centers, or retail stores selling Sunbeam products do not have the right to alter, modify or any way change the terms and conditions of this warranty.

This warranty does not cover normal wear of parts or damage resulting from any of the following: negligent use or misuse of the product, use on improper voltage or current, use contrary to the operating instructions, disassembly, repair or alteration by anyone other than Sunbeam or an authorized Sunbeam service center. Further, the warranty does not cover: Acts of God, such as fire, flood, hurricanes and tornadoes.

What are the limits on Sunbeam’s Liability?

Sunbeam shall not be liable for any incidental or consequential damages caused by the breach of any express, implied or statutory warranty or condition.

Except to the extent prohibited by applicable law, any implied warranty or condition of merchantability or fitness for a particular purpose is limited in duration to the duration of the above warranty.

Sunbeam disclaims all other warranties, conditions or representations, express, implied, statutory or otherwise.

Sunbeam shall not be liable for any damages of any kind resulting from the purchase, use or misuse of, or inability to use the product including incidental, special, consequential or similar damages or loss of profits, or for any breach of contract, fundamental or otherwise, or for any claim brought against purchaser by any other party.

Some provinces, states or jurisdictions do not allow the exclusion or limitation of incidental or consequential damages or limitations on how long an implied warranty lasts, so the above limitations or exclusion may not apply to you.

This warranty gives you specific legal rights, and you may also have other rights that vary from province to province, state to state or jurisdiction to jurisdiction.

How to Obtain Warranty Service

If you have any question regarding this warranty or would like to obtain warranty service, please call 1- 877-689-2737 and a convenient service center address will be provided to you.

In the U.S.A., this warranty is offered by Sunbeam Products, Inc. located in Boca Raton, Florida 33431.

PLEASE DO NOT RETURN THIS PRODUCT TO ANY OF THESE ADDRESSES OR TO THE PLACE OF PURCHASE.

NOTES



DO NOT RETURN THIS PRODUCT TO THE PLACE OF PURCHASE

For product questions:
Jarden Consumer Services U.S.A.
1-877-689-2737

www.margaritavillecargo.com

©2013 Sunbeam Products, Inc. doing business as Jarden Consumer Solutions. All rights reserved.
Distributed by Sunbeam Products, Inc. doing business as Jarden Consumer Solutions,
Boca Raton, Florida Boca Raton, Florida 33431.

Margaritaville® is a registered trademark of Margaritaville. Used with permission.

Printed in China

P. N. 172356

SPR-103013-483P